



# Shark Depredation and Unwanted Bycatch in Pelagic Longline Fisheries

Industry Practices and Attitudes, and Shark Avoidance Strategies



Financial support for the research on which the content of this publication is based has been generously provided by the Western Pacific Regional Fishery Management Council (WPRFMC), Regional Seas Programme of the United Nations Environment Programme (UNEP) and the Gordon and Betty Moore Foundation.

#### DISCLAIMER

The contents of this report do not necessarily reflect the views of WPRFMC, UNEP, the Moore Foundation or other contributory organizations. The designations employed and the presentations do not imply the expression of any opinion whatsoever on the part of WPRFMC, UNEP, the Moore Foundation or other contributory organizations concerning the legal status of any country, territory, city or area in its authority, or concerning the delimitation of its frontiers or boundaries.

© 2007 Western Pacific Regional Fishery Management Council

This publication may be reproduced in whole or in part and in any form for educational or non-profit purposes without special permission from the copyright holder, provided acknowledgement of the source is made. No use of this publication may be made for resale or for other commercial purpose whatsoever without the prior permission in writing from WPRFMC.

Western Pacific Regional Fishery Management Council  
1164 Bishop St., Suite 1400  
Honolulu, Hawaii, 96813 USA  
<http://www.wpcouncil.org>

Cover photos: U.S. North Atlantic longline swordfish vessel landing a blue shark (left, courtesy of Greg Skomal, Massachusetts Division of Marine Fisheries), tuna being offloaded from a Chile industrial swordfish longline vessel (middle, courtesy of Pro Delphinus), and a shark-damaged yellowfin tuna (right, courtesy of the U.S. National Marine Fisheries Service Pacific Islands Regional Office).

For Bibliographic purposes, this document may be cited as:

Gilman, E., Clarke, S., Brothers, N., Alfaro-Shigueto-J., Mandelman, J., Mangel, J., Petersen, S., Piovano, S., Thomson, N., Dalzell, P., Donoso, M., Goren, M., Werner, T. 2007. *Shark Depredation and Unwanted Bycatch in Pelagic Longline Fisheries: Industry Practices and Attitudes, and Shark Avoidance Strategies*. Western Pacific Regional Fishery Management Council, Honolulu, USA.

ISBN: 1-934061-06-9



# Shark Depredation and Unwanted Bycatch in Pelagic Longline Fisheries

Industry Practices and Attitudes, and Shark Avoidance Strategies

2007

By:

Eric Gilman <sup>a</sup>, Shelley Clarke <sup>b</sup>, Nigel Brothers <sup>c</sup>, Joanna Alfaro-Shigueto <sup>d</sup>, John Mandelman <sup>e</sup>, Jeff Mangel <sup>d</sup>, Samantha Petersen <sup>f</sup>, Susanna Piovano <sup>g</sup>, Nicola Thomson <sup>h</sup>, Paul Dalzell <sup>i</sup>, Miguel Donoso <sup>j</sup>, Meidad Goren <sup>f</sup>, Tim Werner <sup>e</sup>

<sup>a</sup> Blue Ocean Institute, USA

<sup>b</sup> National Research Institute of Far Seas Fisheries, JAPAN

<sup>c</sup> Marine Ecology and Technology Consultancy, AUSTRALIA

<sup>d</sup> Pro Delphinus, PERU

<sup>e</sup> New England Aquarium, USA

<sup>f</sup> BirdLife South Africa, SOUTH AFRICA

<sup>g</sup> Università di Torino, ITALY

<sup>h</sup> Environment Consultants Fiji, FIJI

<sup>i</sup> Western Pacific Regional Fishery Management Council, USA

<sup>j</sup> Instituto de Fomento Pesquero, CHILE



## Acknowledgements

This research was made possible through financial support from the Western Pacific Regional Fishery Management Council, Regional Seas Programme of the United Nations Environment Programme and the Gordon and Betty Moore Foundation.

Eric Stroud, SharkDefense LLC, kindly provided information on the development and preliminary results of research on shark repellents. We are grateful for the contribution of photos by Greg Skomal, Massachusetts Division of Marine Fisheries; Sean Van Sommeran, Pelagic Shark Research Foundation; Toshikazu Miyamoto, Global Guardian Trust; and U.S. National Marine Fisheries Service Hawaii Longline Observer Program.

A central objective of this study was to draw upon existing fisher knowledge in the hope that this could be used to improve shark-related management for fishers and sharks. However, achieving this in the face of such diverse economic and cultural contexts could easily have met with skeptical or uncooperative responses by fishers. To the contrary, we acknowledge and are extremely grateful for the willing contribution of fishers who participated in the interviews. Through participating in interviews, 149 vessel captains, fishing masters, crew, vessel and company owners, fishing cooperative staff and port officials of 12 pelagic longline fisheries contributed invaluable information.

For the Australia longline fishery research, John Webb of the Australian Fisheries Management Authority provided data from the pelagic longline fishery observer program, and Ian Freeman shared his considerable knowledge of the fishery and its management. Catherine Bone assisted with data and report collation. John Stevens and Jeff Dambacher of the Australian Commonwealth Scientific and Research Organization, Marine and Atmospheric Research Laboratory, assisted by discussion generally and with access to fisheries statistics.

For assistance with preparation of the Chile and Peru chapters we would like to thank Pro Delphinus staff members Mariela Pajuelo and Celia Caceres.

We are grateful for the contribution of the following experts who assisted with development of the case study on the Fiji pelagic longline fishery: Tim Lawson, Deidre Brogan and William Sokimi, Oceanic Fisheries Programme, Secretariat of the Pacific Community; Anare Raiwalui, Apolosi Turaganivalu and Neomai Turaganivalu-Ravitu, Fiji Department of Fisheries; Grahame Southwick, Fiji Fish Limited; Robert Stone, StoneFish (Fiji) Limited; Pio Manoa, University of the South Pacific; and Nilesh Goundar, Greenpeace South Pacific Programme.

We are grateful for assistance provided with interviews by Giovanni Basciano, Roberto Ardizzone, Vincenzo Gennuso, Sergio Lombardo, and Ilaria Rinaudo of the General Association of Italian Cooperatives - Fishery sector.

Information collected for the case study of Japanese longline fisheries is based on interviews, catch records held by the National Research Institute for Far Seas Fisheries (Japan Fisheries Research Agency), and other published information as cited. The Organization for Promotion of Responsible Tuna Fisheries, the Global Guardian Trust (GGT) and the National Research Institute of Far Seas Fisheries (NRIFSF) provided essential assistance in data access and compilation. Toshikazu Miyamoto of GGT and Ziro Suzuki of NRIFSF assisted with fishermen interviews in Kesenuma, Kii-Katsuura, Yaizu and Misaki seaports.

The authors also wish to acknowledge the assistance of Sean Martin, Scott Barrows and Jim Cook of the Hawaii Longline Association.

We are thankful for invaluable comments provided by Dave Kerstetter and Larry Beerkircher and information provided by Nelson (1953-2006) and Terri Beideman of the Blue Water Fishermen's Association for the U.S. Atlantic case study. Support for the Atlantic case study was provided by the Consortium for Wildlife Bycatch and the New England Aquarium's Research Department.

## Contents

	Page
<b>Contents</b> .....	i
<b>Summary and Conclusions</b> .....	vii
<b>Chapter 1. Introduction and Methods</b> .....	1
1.1. Bycatch and Depredation, Sharks and Pelagic Longline Fisheries	
1.2. Methods	
<b>Chapter 2. Fishing Gear and Operational Characteristics</b> .....	4
<b>Chapter 3. Shark Catch Rates and Disposition</b> .....	9
<b>Chapter 4. National and International Measures</b> .....	12
4.1. Summary and Effects of National/EC Legislation on Shark Interactions	
4.2. International Initiatives Addressing Shark Finning	
4.3. Conclusions on Data Collection and Management Frameworks	
<b>Chapter 5. Economic, Practical, Ecological and Social Problems from Shark – Longline Interactions</b> .....	16
5.1. Economic and Practical Concerns	
5.2. Ecological Concerns	
5.3. Social Concerns	
<b>Chapter 6. Industry Attitudes and Practices</b> .....	22
6.1. Industry Attitudes	
6.2. Industry Practices	
6.2.1. Avoid peak areas and periods of shark abundance	
6.2.2. Reduce shark detection of baited hooks	
6.2.3. Reduce shark catch rate through deeper setting, line material or type of bait or hook	
6.2.4. Reduce injury to discarded sharks	
6.2.5. Reduce retention of sharks on branch lines	
<b>Chapter 7. Potential of Deterrents, Hotspot Avoidance and Incentive Instruments to Reduce Shark Interactions in Pelagic Longline Fisheries</b> .....	30
7.1. Shark Deterrents	
7.2. Hotspot Avoidance through Fleet Communication and Protected Areas	
7.3. Incentive Instruments	
7.3.1. National and local constraints	
7.3.2. Regional and international accords, regulations, and policies	
7.3.3. Eco-labeling	
7.3.4. Industry and market self-policing	
<b>Chapter 8. References</b> .....	35
<b>Appendices – Case Studies and Contributing Authors’ Contact Details</b>	
<b>Appendix 1. Australia Longline Tuna and Billfish Fishery</b> .....	40
A1.1. Fisheries Management Jurisdiction	
A1.2. Shark Fisheries in Australian Waters	
A1.3. Introduction to the Australian Pelagic Longline Fishery	

- A1.3.1. Target species
- A1.3.2. Management regime
- A1.3.3. Size of fleet
- A1.3.4. Vessel type
- A1.3.5. Crew
- A1.3.6. Fishing gear
- A1.3.7. Bait type
- A1.3.8. Target catch
- A1.3.9. Shark catch
- A1.3.10. Catch storage
- A1.3.11. Trip length
- A1.3.12. Daily fishing pattern
- A1.3.13. Market
- A1.4. Shark Species Encountered by Pelagic Longline Vessels in Australian Waters
- A1.5. Shark Catch Rates in Australian Pelagic Longline Fisheries
- A1.6. Influence of International Initiatives on Domestic Shark Management
- A1.7. National Management Processes for Sharks in Australia
- A1.8. National Regulations
  - A1.8.1. Regulated fishing effort
  - A1.8.2. Retention limits per trip
  - A1.8.3. Finning at sea prohibition
  - A1.8.4. Prohibited use of a wire trace
- A1.9. Fishing Practices that Affect Shark Catches
  - A1.9.1. Fishing location
  - A1.9.2. Line set, soak and haul duration, depth and timing
  - A1.9.3. Bait type
  - A1.9.4. Line weighting
  - A1.9.5. Method used to dispatch captured fish
  - A1.9.6. Hook type
- A1.10. Survey of Shark Fishing Practices, Handling Strategies, and Fishers' Opinions of Sharks and Shark Management
  - A1.10.1. Methods
  - A1.10.2. Survey results
- A1.11. Additional Notes of Survey Respondents' Comments
- A1.12. References

**Appendix 2. Chile Artisanal Longline Mahimahi and Shark Fishery and.....68**  
**Longline Swordfish Fishery**

- A2.1. Artisanal Longline Fishery Characteristics
- A2.2. The Industrial and Artisanal Swordfish Fishery
- A2.3. The Elasmobranch Fishery
- A2.4. Range of Fishing Gear and Methods
  - A2.4.1. Artisanal mahi mahi longline
  - A2.4.2. Industrial swordfish fishery
- A2.5. Catch and Discard Rates of Target and Bycatch Species
- A2.6. Regulations and Management Framework
- A2.7. Shark Market and Management Framework
- A2.8. Economic, Social, and Ecological Effects, Including Effects on Fishing Practices, from Regulations Governing Shark Interactions
- A2.9. Practices to Deal with Caught Sharks and Costs from Shark Depredation and Gear Damage
- A2.10. Methods for Onboard Processing of Retained Sharks
- A2.11. Reasons for Discarding Sharks
- A2.12. Practices Employed to Reduce Shark Capture and Depredation
- A2.13. Reasons for Discontinuing any Methods Attempted to Reduce Shark Interactions
- A2.14. Perceptions on Efficacy and Commercial Viability of Strategies to Reduce Shark Interactions

- A2.14.1. Avoiding peak areas and times of shark abundance
- A2.14.2. Reducing the detection of baited hooks by sharks, such as by refraining from chumming during the set and not discarding offal and spent bait during the haul
- A2.14.3. Limiting shark access to baited hooks, such as altering fishing practices to consider deployment depth of hooks and timing of the soak and haul to avoid problematic shark species
- A2.14.4. Deterring sharks such as with chemical shark deterrents and electrical deterrents
- A2.14.5. Reducing the attractiveness of baited hooks to sharks, such as by using artificial baits, using or not using light sticks, or avoiding a bait type known to result in high shark catch rates
- A2.14.6. Reducing injury to hooked sharks that you will discard
- A2.14.7. Reducing shark retention by avoiding a specific size or type of hook, or by not using wire leaders on branch lines
- A2.14.8. Will the economic impact of sharks be reduced from using a wire leader on branch lines
- A2.14.9. Most important factor that affects shark CPUE
- A2.15. Incentives and Attitudes on Reducing Shark Bycatch and Depredation
- A2.16. Supporting Figures
- A2.17. References

### **Appendix 3. Fiji Pelagic Longline Tuna Fishery..... 88**

- A3.1. Introduction
- A3.2. Methods
- A3.3. Fiji Fleet Characteristics
- A3.4. Range of Fishing Gear and Methods
- A3.5. Catch and Discard Rates of Target and Bycatch Species
- A3.6. Management Framework Relevant to Shark Interactions and its Effect on Fishermen
- A3.7. Current Response to Shark By-Catch by Fiji Pelagic Longliners
  - A3.7.1. Methods for onboard processing and discarding of sharks
  - A3.7.2. Practices employed to reduce shark capture
  - A3.7.3. Distribution of revenue from sharks
  - A3.7.4. Ex-vessel value of landed sharks
  - A3.7.5. Revenue from catching sharks relative to economic costs from shark depredation and gear damage
- A3.8. Current Response to Shark Depredation by Fiji Pelagic Longliners
  - A3.8.1. Frequency and effects of shark depredation
  - A3.8.2. Practices employed to reduce shark depredation
- A3.9. Perceptions on Efficacy and Commercial Viability of Strategies to Reduce Shark Interactions
- A3.10. Incentives and Attitudes on Reducing Shark Bycatch and Depredation
- A3.11. References

### **Appendix 4. Italy Mediterranean Industrial Longline Swordfish Fishery..... 100**

- A4.1. Introduction
- A4.2. Fleet Characteristics
- A4.3. Fishing Gear
- A4.4. Shark Bycatch
- A4.5. Mediterranean Sea
  - A4.5.1. Adriatic Sea
  - A4.5.2. Ionian Sea
  - A4.5.3. Ligurian Sea
  - A4.5.4. Tyrrhenian Sea and Strait of Sicily
- A4.6. Interview Results
- A4.7. Shark Trade
- A4.8. References

### **Appendix 5. Japan Pelagic Longline Fisheries..... 111**

- A5.1. Introduction and Methods
- A5.2. Historical Fleet Development, Shark Catches and Gear Configurations
- A5.3. Current Fleet Characteristics and Shark Catches
  - A5.3.1. Number of vessels by size class
  - A5.3.2. Catch and effort by vessel class and operational behavior
  - A5.3.3. Calculation of nominal shark CPUE
  - A5.3.4. Species composition of shark catches in longline fleets
- A5.4. Management Framework Relevant to Shark Interactions
- A5.5. Shark Handling and Disposition Practices by Fleet
  - A5.5.1. Enyo fleet handling and disposition
  - A5.5.2. Kinkai fleet handling and disposition
  - A5.5.3. Engan fleet handling and disposition
- A5.6. Depredation and Gear Damage Issues
- A5.7. Methods of Onboard Storage of Retained Sharks
- A5.8. Practices Employed to Reduce Shark Capture and Depredation
- A5.9. Reasons for Discontinuing any Methods Attempted to Reduce Shark Interactions
- A5.10. Perceptions on Efficiency and Commercial Viability of Strategies to Reduce Shark Interactions
  - A5.10.1. Avoiding Areas with Sharks
  - A5.10.2. Refraining from chumming or bait/offal disposal
  - A5.10.3. Changing target depth and soak time
  - A5.10.4. Chemical and electrical deterrents
  - A5.10.5. Artificial bait and other changes to bait type or attraction
  - A5.10.6. Reducing injury to discarded sharks
  - A5.10.7. Change in gear (hooks or leaders)
  - A5.10.8. Most important factor in determining shark CPUE
- A5.11. Incentives and Attitudes toward Reducing Shark Bycatch and Depredation
- A5.12. References

**Appendix 6. Peru Artisanal Pelagic Longline Mahi Mahi and Shark Fishery..... 135**

- A6.1. Elamobranch Fishery
- A6.2. Artisanal Longline Fleet Characteristics
- A6.3. Range of Fishing Gear and Methods
- A6.4. Catch and Discard Rates of Target and Bycatch Species
- A6.5. Regulations and their Implications for a Management Framework
- A6.6. Shark Market and Implications for the Management Framework
- A6.7. Economic, Social and Ecological Effects, Including Effects on Fishing Practices, from Regulations Governing Shark Interactions
- A6.8. Practices to Deal with Caught Sharks and Costs from Shark Depredation and Gear Damage
- A6.9. Methods for Onboard Processing of Retained Sharks
- A6.10. Reasons for Discarding Sharks
- A6.11. Practices Employed to Reduce Shark Capture and Depredation
- A6.12. Reasons for Discontinuing any Methods Attempted to Reduce Shark Interactions
- A6.13. Perceptions on Efficacy and Commercial Viability of Strategies to Reduce Shark Interactions
  - A6.13.1. Avoiding peak areas and times of shark abundance
  - A6.13.2. Reducing the detection of baited hooks by sharks, such as by refraining from chumming during the set and not discarding offal and spent bait during the haul
  - A6.13.3. Limiting shark access to baited hooks, such as altering fishing practices to consider deployment depth of hooks and timing of the soak and haul to avoid problematic shark species
  - A6.13.4. Detering sharks such as with chemical shark deterrents and electrical deterrents
  - A6.13.5. Reducing the attractiveness of baited hooks to sharks, such as by using artificial baits, using or not using light sticks, or avoiding a bait type known to result in high shark catch rates
  - A6.13.6. Reducing injury to hooked sharks that you will discard



- A6.13.7. Reducing shark retention by avoiding a specific size or type of hook, or by not using wire leaders on branch lines
- A6.13.8. Will the economic impact of sharks be reduced from using a wire leader on branch lines
- A6.13.9. What is the most important factor that affects shark CPUE - altering fishing position in relation to certain water temperature, topographic features, or oceanographic features; changing the time of day or month of setting or hauling; changing the depth of hooks, or a combination of these factors?
- A6.14. Incentives and Attitudes on Reducing Shark Bycatch and Depredation
- A6.15. Supporting Figures
- A6.16. References

**Appendix 7. South Africa Pelagic Longline Tuna and Swordfish Fishery.....151**

- A7.1. Introduction
- A7.2. Data Sources
- A7.3. History of the Fishery and Effort Trends
- A7.4. Fishing Gear and Operations
- A7.5. Shark Bycatch Composition and Catch Rates
  - A7.5.1. Catch composition
  - A7.5.2. Perception of interviewees
- A7.6. Management Framework Relevant to Shark Interactions
- A7.7. Economic, Social and Ecological Effects, Including Effects on Fishing Practices, from Regulations Governing Shark Interactions
- A7.8. Practices to Deal with Caught Sharks
- A7.9. Methods for Onboard Processing of Retained Sharks
- A7.10. Shark Depredation and Gear Damage
- A7.11. Practices Employed to Reduce Shark Capture
- A7.12. Incentives and Attitudes on Reducing Shark Bycatch and Depredation
- A7.13. Acknowledgements
- A7.14. References

**Appendix 8. USA Hawaii Longline Swordfish and Tuna Fisheries..... 162**

- A8.1. Fleet Development and Characteristics
- A8.2. Range of Fishing Gear and Methods
- A8.3. Catch and Discard Rates of Target and Bycatch Species
- A8.4. Management Framework Relevant to Shark Interactions
- A8.5. Economic, Social, and Ecological Effects, Including Effects on Fishing Practices, from Regulations Governing Shark Interactions
- A8.6. Practices to Deal with Caught Sharks and Costs from Shark Depredation and Gear Damage
- A8.7. Onboard Processing of Retained Sharks
- A8.8. Reasons for Discarding Sharks
- A8.9. Practices Employed to Reduce Shark Capture and Depredation
- A8.10. Reasons for Discontinuing any Methods Attempted to Reduce Shark Interactions
- A8.11. Perceptions on Efficacy and Commercial Viability of Strategies to Reduce Shark Interactions
  - A8.11.1. Avoiding peak areas and times of shark abundance
  - A8.11.2. Reducing the detection of baited hooks by sharks, such as by refraining from chumming during the set and not discarding offal and spent bait during the haul
  - A8.11.3. Limiting shark access to baited hooks, such as altering fishing practices to consider deployment depth of hooks and timing of the soak and haul to avoid problematic shark species
  - A8.11.4. Deterring sharks such as with chemical shark deterrents and electrical deterrents
  - A8.11.5. Reducing the attractiveness of baited hooks to sharks, such as by using artificial baits, using or not using light sticks, or avoiding a bait type known to result in high shark catch rates
  - A8.11.6. Reducing injury to hooked sharks that you will discard

- A8.11.7. Reducing shark retention by avoiding a specific size or type of hook, or by not using wire leaders on branch lines
- A8.11.8. Will the economic impact of sharks be reduced from using a wire leader on branch lines
- A8.11.9. What is the most important factor that affects shark CPUE - altering fishing position in relation to certain water temperature, topographic features, or oceanographic features; changing the time of day or month of setting or hauling; changing the depth of hooks, or a combination of these factors?
- A8.12. Incentives and Attitudes on Reducing Shark Bycatch and Depredation
- A8.13. References

**Appendix 9. U.S.A. Atlantic, Gulf of Mexico and Caribbean Longline Swordfish and Tuna ...180  
Fisheries**

- A9.1. Introduction
  - A9.1.1. Caveats in available data sets and reports
  - A9.1.2. Geographic fishing zones and status of the fleet
  - A9.1.3. Gear types
  - A9.1.4. Management parameters
  - A9.1.5. Shark management
- A9.2. Incidental Shark Takes in the Atlantic
  - A9.2.1. General takes according to species
  - A9.2.2. Takes according to region and alternative factors
  - A9.2.3. Shark depredation
- A9.3. Potential Strategies to Reduce Shark Interactions and Mortality
  - A9.3.1. That related to other taxa or fisheries
  - A9.3.2. That related to pelagic operations
  - A9.3.3. Effects of J-style versus circle hooks
  - A9.3.4. Ongoing work on hook repellants
  - A9.3.5. Next steps
- A9.4. References

**Appendix 10. Contributing Authors' Contact Details..... 203**

## Summary and Conclusions

Substantial ecological, economic and social problems result from shark interactions in pelagic longline fisheries. Improved understanding of industry attitudes and practices towards shark interactions assists with managing these problems. Information on fisher knowledge and new strategies for shark avoidance may benefit sharks and fishers. A study of 12 pelagic longline fisheries from eight countries shows that incentives to avoid sharks vary along a continuum, based on whether sharks represent an economic disadvantage or advantage. Shark avoidance practices are limited, including avoiding certain areas, moving when shark interaction rates are high, using fish instead of squid for bait and deeper setting. Some conventionally employed fishing gear and methods used to target non-shark species contribute to shark avoidance. Shark repellents hold promise; more research and development is needed. Development of specifically designed equipment to discard sharks could improve shark post release survival prospects, reduce gear loss and improve crew safety. With expanding exploitation of sharks for fins and meat, improved data collection, monitoring and precautionary shark management measures are needed to ensure shark fishing mortality levels are sustainable.

In some pelagic longline fisheries, shark interactions pose substantial economic, ecological and social problems. Information on existing fisher knowledge and new strategies for shark avoidance may benefit sharks and fishers wanting to reduce shark interactions. Improving the understanding of current and projected future longline industry attitudes and practices towards shark interactions will provide industry and management authorities with better information to manage these problems.

This project collected information from a diverse range of pelagic longline fisheries in eight countries (Australia, Chile, Fiji, Italy, Japan, Peru, South Africa, and U.S.A.) to:

- (i) Describe the range of attitudes by the longline industry towards shark interactions;
- (ii) Identify methods to reduce shark depredation (the partial or complete removal of hooked fish and bait from fishing gear) and unwanted bycatch currently in practice; and
- (iii) Identify promising new concepts for shark avoidance and obstacles that must be overcome for their implementation.

Information was collected through interviews with 149 vessel captains, fishing masters, crew, vessel and company owners, fishing cooperative staff and port officials at 24 fishing seaports for 12 pelagic longline fisheries from these eight countries, reviewing available information from the literature, and analyzing observer and logbook data. The scope of fisheries ranged from small-scale domestic artisanal fisheries to modern mechanized industrial fleets of distant water fishing nations.

In some non-shark pelagic longline fisheries, sharks comprise a large proportion of the total catch. For instance, sharks comprise > 25% of the total catch in the Australia longline tuna and billfish fishery and Fiji longline tuna fishery. Sharks comprised 50% of the catch of the Hawaii-based longline swordfish fishery prior to a prohibition on the use of squid for bait, where sharks now comprise 32% of the catch. Blue sharks comprise the largest proportion of shark species caught in all 12 of the fisheries included in this study, ranging from 47% - 92% of shark catch in fisheries where this information is available. For fisheries where shark catch rates are available, these range from 0.7 to 17 sharks per 1000 hooks. The location of fishing grounds and characteristics of fishing gear and methods are primary factors determining a fleet's shark catch rate. Certain gear designs (e.g., use of a wire leader, use of squid for bait, and depth of baited hooks) contribute to high shark catch rates. Shallow setting pelagic longline fisheries generally have higher shark catch rates than deeper setting fisheries. Gear designs are extremely variable between fisheries, as well as from seaport to seaport, by season and fishing ground within a fishery, between vessels within a fishery, and for some parameters, within the gear of an individual vessel.

Incentives to reduce shark interactions in pelagic longline fisheries vary along a continuum, based on whether sharks represent an economic disadvantage or advantage. On one extreme, there are pelagic longline fisheries with a regulatory framework limiting shark catches or placing restrictions on shark handling, or lack of markets for shark products, resulting in negligible retention of sharks. In these fisheries, the costs from shark interactions exceed benefits from revenue from sharks, due to:

- (i) Depredation;
- (ii) Damage and loss of gear;
- (iii) Reduced catch of marketable species due to baited hooks being occupied or removed by sharks;
- (iv) Risk of crew injury from handling caught sharks and being hit by weights when branch lines containing sharks break during gear retrieval; and
- (v) Reduced fishing efficiency due to the time required to remove sharks from gear for discarding and to repair and replace gear.

Fishers identified the time required to repair damaged and lost gear from shark interactions, and to remove sharks to be discarded from gear, as a substantial problem. Lost revenue from shark damage to target species can amount to several thousand U.S. dollars in a single set in some fisheries. In some of these fisheries, there is large interest in minimizing shark interactions. On the other extreme, there are pelagic longline fisheries where revenue from sharks exceeds costs from shark interactions, a large proportion of caught sharks are retained (> 99% in some fisheries), and sharks are either always an important target species, are targeted seasonally or at certain fishing grounds proximate to ports where there is demand for shark products, or are an important incidental catch species.

Several nations, including half of the countries covered in this study (Australia, Italy, South Africa, and U.S.A.), have legally binding prohibitions in effect on the removal of shark fins (including the tail) and discarding of the remainder of the shark at sea in their pelagic longline fisheries. Some of the longline fisheries included in this study are subject to prohibitions on the use of wire leaders (Australia, South Africa), have shark retention trip limits (Australia, South Africa), and have size limits for certain shark species (Peru). Fishers in the Italian sector of the Mediterranean industrial longline swordfish fishery are unaware of the finning restriction, and thus the legislation does not affect their practices. However, no shark finning is reported to occur in the fishery due to the lack of a local market for the fins. In the fisheries in Australia, South Africa, and Hawaii, U.S.A., finning restrictions have substantially reduced shark retention, most captured sharks are now discarded alive, while revenue from sharks has been substantially reduced. Japanese longline fishermen in the distant water fleet have adapted to finning regulations applicable in some areas by landing sharks in recently developed local markets rather than by attempting to avoid shark interactions. In waters without finning regulations, including Japanese waters and the North Pacific, sharks are either finned or landed whole, and in either case the ability to sell shark products has contributed to a lack of interest in reducing shark bycatch. A trip limit on the retention of shark carcasses in Australia has likely had no effect on industry practices, as vessels typically will not reach the per-trip limit for shark species that are worth retaining. A shark per-trip retention limit in South Africa may have a large adverse economic effect; however, there may be low compliance. A shark size limit in effect in the Peru longline fishery is not strongly enforced, and few fishers are aware of the rule. Of the few fishers who reported that they were aware of the regulations, all report that they still retain sharks that are under the minimum size limit. A prohibition on the use of a wire trace in the Australia and South Africa longline fisheries has resulted in an increased economic cost from shark interactions from an increase in lost terminal tackle. In fisheries where most sharks are released alive, it is not known how the injury to sharks from retaining hook and trailing monofilament line affects their survival prospects compared to being caught on lines with wire trace. In fisheries where a large proportion of caught sharks are killed either for retention or discarding, prohibiting wire leaders will likely reduce shark fishing mortality. Prohibiting wire leaders may exacerbate seabird bycatch problems: Fishers will be less likely to attach weights close to hooks on branch lines lacking a

wire leader due to safety concerns, thus, reducing the baited hook sink rate, and increasing seabird catch rates.

In fisheries where there is an incentive to avoid shark interactions, predominant shark avoidance practices are to:

- (i) Avoid fishing in areas known to have high shark interactions; and
- (ii) Change fishing grounds when shark catch rates, depredation and gear loss are high but the target species catch rate is low.

Some fishers indicate that using fish instead of squid for bait reduces shark interactions. Experimental trials have shown that using fish instead of squid as bait results in a significant and large decrease in shark catch rates. However, results of trials of different hook types are less conclusive, with some studies showing small but significant increases in shark catch rates with a circle hook, and other studies indicating no difference between circle and other hooks. Longline fishers identified numerous fishing methods and gear characteristics that they conventionally employ to maximize catch rates of non-shark target species, which may contribute to reducing shark catch rates. For instance, the depth of baited hooks; timing of gear setting, soak and hauling; location of fishing grounds in relation to topographic and oceanographic features (e.g., position with regard to oceanic fronts); type and size of bait and hook; leader material; non-use of lightsticks; and other fishing methods and gear designs selected by fishermen to maximize their non-shark target species catch rates may be effective shark avoidance strategies. Research is needed to improve the understanding of the shark avoidance efficacy of these practices.

Beyond these strategies, the state of knowledge to reduce unwanted bycatch and depredation by sharks in pelagic longline fisheries is poor. A prioritized next step is to test promising, new strategies to reduce unwanted shark bycatch, depredation and gear damage in pelagic longline fisheries. Shark deterrents that hold promise include chemical, magnetic, electropositive rare earth metals, and electrical deterrents. Some of these strategies are concepts requiring substantial investment to develop the technology for application in longline gear. Research and commercial demonstrations are needed to assess effects of these deterrents on catch rates of sharks, target and incidental species. Fleet communication programs can enable a longline fleet to avoid shark hotspots. The distribution of sharks in some fishing grounds is often unpredictable, and may be spatially contagious or aggregated. Consequently, fleet communication systems may be employed by fishing industry to report near real-time observations of hotspots to enable a fishery to coordinate operations to substantially reduce fleet-wide depredation and bycatch of sharks. In addition, fleet coordination of daily fishing positions and times, a current practice in many nations' fleets, may minimize per vessel shark depredation and catch levels relative to vessels that fish in isolation. Such techniques will only be of interest in fisheries where shark interactions pose a substantial economic disadvantage. These shark avoidance strategies promise to benefit shark populations as well as those fisheries where shark interactions are an economic disadvantage.

A large proportion of pelagic shark species are alive when gear is retrieved. Reducing gear soak time would increase the proportion of caught sharks that are alive when hauled to the vessel. In longline fisheries where information is available, most sharks that are alive when hauled to the vessel and will be discarded are released alive. When a caught shark is discarded, fishers indicate that most of the time they will either cut branch lines, cut the hook out of the shark's mouth or pull the hook out by force in order to retrieve the terminal tackle before discarding the shark. It is uncommon for fishers to kill a shark to retrieve terminal tackle or to prevent future shark interactions. Most fishers perceive commercially available de-hooker devices to be impractical and potentially dangerous for use with sharks. While available information indicates that a large proportion of sharks caught in longline gear that are released after removal of the hook will survive, and while many fishers do not see a need for new hook removal methods, development of especially designed equipment to discard sharks could

improve shark post release survival prospects, reduce the loss of terminal tackle and improve crew safety.

In fisheries where shark finning occurs, to avoid injury and increase efficiency, crew first kill the fish before removing fins, and do not remove fins from live sharks.

A recent trend of expanding demand for shark meat at several ports worldwide is creating a shift in utilization of shark meat in some fisheries. In these fisheries, there is increased incentive to target and catch sharks. Given the increasing globalization of fish markets, this trend could spread to other fisheries where currently there are no markets for shark meat. This trend toward more utilization of shark meat may be beneficial in the short term in that fully utilized sharks are more likely to be reported in logbooks and landings statistics than are the retention and landing of just fins. However, if the shark meat market continues to grow, this will likely lead to a rapid increase in shark catch rates and fishing mortality.

This study shows that fishers possess the knowledge to modify their fishing gear and methods to maximize shark catch. Sharks are particularly vulnerable to overexploitation and slow to recover from large population declines. The expanding exploitation of sharks, for their fins as well as meat, warrants concern for the health of shark populations as well as ecosystem-level effects from population declines. This is compounded by the absence of effective management frameworks in most fisheries, in combination with the lack of both reliable fishery-dependent data and fundamental biological information for most shark species. Of the 12 fisheries included in this study, only two are subject to shark retention trip limits, while five have no measures to manage shark interactions. Thus, to prepare for a possible increase in demand for shark meat, in areas where sharks are target species or could become targets, fishery management authorities are encouraged to begin effective data collection, monitoring and precautionary shark management measures to ensure that shark fishing mortality levels are sustainable.

## Chapter 1

### Introduction and Methods

#### 1.1. Bycatch and Depredation, Sharks and Pelagic Longline Fisheries

Bycatch<sup>1</sup> in marine fisheries is an increasingly prominent international ecological, social, and economic issue (Alverson et al., 1994; IUCN, 1996a,b, 2000a,b; Hall et al., 2000; Cook, 2001; Gilman, 2001; Dobrzynski et al., 2002; FAO, 1999a,b,c, 2004a,b; Gilman et al., 2005, 2006a,b,c,d, 2007). The issue has been considered in a growing number of international conventions, treaties, and resolutions, including Agenda 21 (1992); the Cancun Declaration (1992); UN General Assembly Resolutions 49/118 (1994) and 50/25 (1995); the Rome Consensus on World Fisheries (1995); the Kyoto Declaration and Plan of Action (1995), the United Nations Food and Agriculture Organization International Code of Conduct for Responsible Fisheries (1995) and International Plan of Action for Reducing Incidental Catch of Seabirds in Longline Fisheries (1999), and Agreement on the Conservation of Small Cetaceans in the Baltic and North Seas Resolution on Incidental Take of Small Cetaceans (2003) (Haward et al., 1998; Hall et al., 2000; Gilman, 2001).

Economic effects on fisheries from bycatch include the imposition of a range of restrictions, closed areas, embargos, and possible closures; fishery interactions, where bycatch in one fishery reduces target catch in another, and bycatch of juvenile and undersized individuals of a commercial species can adversely affect future catch levels (Hall et al., 2000).

Bycatch raises ecological concerns, as some bycatch species of marine mammals, seabirds, sea turtles, sharks<sup>2</sup>, and other fish species are particularly sensitive to increased mortality above natural levels because of their life history traits, including being long-lived, having delayed maturity, and having low reproductive rates (Musick et al., 2000; Bonfil, 2002; Gilman et al., 2005, 2006b). Bycatch can alter biodiversity by removing top predators and prey species at unsustainable levels. It also alters foraging habits of species that learn to take advantage of discards (Hall et al., 2000).

Discarded bycatch is a social issue over waste. Alverson et al. (1994) estimated that in 1994 about 27 million metric tons (27% of the world catch), ranging between 17.9 and 39.5 million tons, of fish per year were discarded at sea. FAO (1999c) estimated that 1998 global marine fisheries fish discards totaled 20 million metric tons.

Depredation, the partial or complete removal of hooked fish and bait from fishing gear, is conducted primarily by cetaceans and sharks in pelagic longline fisheries. Economic losses from depredation can be substantial (Lawson, 2001; Nishida and Shiba, 2002). Depredation also raises ecological concerns as these interactions may change cetacean and shark foraging behavior and distribution, increase fishing effort, and confound fish stock assessments, as well as result in deliberate injury and mortality of cetaceans and sharks by fishers to discourage depredation and avoid future interactions (Gilman et al., 2006d).

Pelagic longlining occurs throughout the world's oceans, has been used since the nineteenth century, and ranges from small-scale domestic artisanal fisheries with small sometimes open vessels to modern mechanized industrialized fleets from distant-water fishing nations with large vessels. Pelagic longlines,

---

<sup>1</sup> 'Bycatch' is used in this report to refer to the retained catch of non-targeted species or 'incidental catch', plus all discards (McCaughan, 1992; Alverson et al., 1994). 'Target' catch is the catch of a species or species assemblage primarily sought in a fishery, while 'non-target' catch is the catch of a species or species assemblage not primarily sought. 'Incidental' catch is the portion of non-target catch that is retained, while 'discards' is the portion of non-target catch that is not retained (McCaughan, 1992; Alverson et al., 1994).

<sup>2</sup> The term 'sharks' is generally used in this report to refer to the Chondrichthyan fishes, which comprise elasmobranchs (sharks, skates and rays) and holocephalans (chimaeroids).

where gear is suspended from floats drifting at the sea-surface, mainly target large tunas (*Thunnus* spp), swordfish (*Xiphias gladius*), other billfishes (*Istiophoridae* spp), and dolphin fish (mahimahi) (*Coryphaena* spp), can be up to 100 km long and carry up to 3,500 baited hooks (Brothers et al., 1999). Fig. 1.1 shows a generalized configuration of pelagic longline gear. However, the gear design, including lengths and materials of float, main, and branch lines; number of hooks between floats; amount and placement of weights on branch lines; depth of gear; and types of hooks and bait; as well as methods of setting and hauling, will vary between fisheries, between vessels in a fishery, by season and fishing grounds for an individual vessel, and even within the gear of an individual vessel.

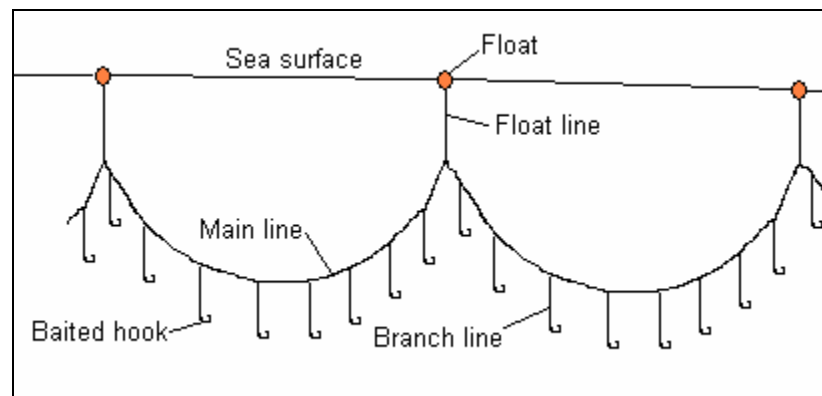

Fig. 1.1. Generalized configuration of pelagic longline gear.

Much progress has been made to identify effective, commercially viable, and even operationally beneficial methods to significantly reduce seabird and sea turtle bycatch in longline fisheries (Gilman et al., 2003, 2005, 2006b, 2007; Watson et al., 2005). Bycatch of seabirds and sea turtles in pelagic longline fisheries poses a substantial threat to some albatross, large petrel, leatherback sea turtle (*Dermochelys coriacea*) and loggerhead sea turtle (*Caretta caretta*) populations (Brothers et al, 1999; FAO, 2004a,b; Gilman, 2001; Gilman et al., 2005, 2006a,b). Relatively little progress has been made to reduce cetacean and shark interactions in longline fisheries (Gilman et al., 2006d).

In some pelagic longline fisheries, especially in fleets that have restrictions on shark finning, unwanted shark bycatch and depredation pose substantial ecological, economic, and social problems. As demonstrated in some fisheries to address seabird and sea turtle bycatch (Gilman et al., 2005, 2006b; Martin et al., 2006), collaborative approaches, which tap fishers' large repository of knowledge, may likewise successfully reduce unwanted shark interactions.

We collect information from longline industries ranging from small-scale artisanal fisheries to large-scale industrial distant water fleets to obtain a more complete understanding of shark-pelagic longline interactions, current fisher attitudes and practices employed in response to shark interactions, identify methods to avoid shark interactions, identify research priorities and assess the effects of legislation that affect longline practices in catching and processing sharks. Information on existing fisher knowledge and new strategies for shark avoidance may benefit sharks and fishers wanting to reduce shark interactions. Improving the understanding of longline industry attitudes and practices towards shark interactions provides industry and management authorities with better information to address these problems.

## 1.2. Methods

Information was collected from the following 12 pelagic longline fisheries from eight countries: (i) Australia longline tuna (*Thunnus* spp) and billfish (*Istiophoridae* spp) fishery, (ii) Chile artisanal mahi mahi (dolphinfish) (*Coryphaena* spp) and shark fishery, (iii) Chile swordfish (*Xiphias gladius*) fishery, (iv) Fiji longline tuna fishery, (v) Italy Mediterranean industrial longline swordfish fishery, (vi) Japan distant water longline fishery, (vii) Japan offshore longline fishery, (viii) Japan nearshore longline fishery, (ix) Peru artisanal mahi mahi and shark fishery, (x) South Africa longline tuna and swordfish fishery, (xi) US



Hawaii longline tuna fishery, and (xii) US Hawaii longline swordfish fishery. Information from the U.S. Atlantic, Caribbean and Gulf of Mexico longline swordfish and tuna fisheries are also included in this assessment, however, no interviews with fishers from these fisheries were conducted as part of this study. From January - December 2006, 149 vessel captains, fishing masters, crew, vessel and company owners, fishing cooperative staff and port officials from these 12 fisheries were interviewed at 24 fishing seaports (nine seaports in Australia, including the main port of Mooloolabah; Arica, Iquique and Valparaiso, Chile; Suva, Fiji; Sicily, Italy; Kesennuma, Kii-Katsuura, Yaizu and Misaki, Japan; Ilo, Paita and Salaverry, Peru; Cape Town Harbour, Hout Bay Harbour and Richards Bay Harbour, South Africa; and Honolulu, U.S.A.). Table 1.1 summarizes the breakdown of who was interviewed for each fleet included in the study.

Table 1.1. Number of people by employment status interviewed in 12 fisheries included in the study of shark depredation and bycatch in pelagic longline fisheries.

Employment Category of Interviewees	Number People Interviewed							
	Australia Longline Tuna and Billfish Fishery	Chile Artisanal Mahimahi and Shark Fishery and Swordfish Fishery	Fiji Longline Tuna Fishery	Italy Mediterranean Industrial Longline Swordfish Fishery	Japan Distant Water, Offshore and Nearshore Longline Fisheries	Peru Artisanal Mahi and Shark Fishery	South Africa Longline Tuna and Swordfish Fishery	USA Hawaii Longline Tuna and Swordfish Fisheries
Captain (Skipper) or Fishing Master	11	13	5	17	19	16	10	10
Vessel or Company Owner (Non-Captain)	3	2	1	0	2	0	0	0
Crew	0	7	0	0	1	26	0	2
Fishing Cooperative Representative	0	0	0	0	3	0	0	0
Port Official	0	0	0	0	1	0	0	0

Information from the interviews; analyses of available logbook and observer data; and a review of the literature was collected and analyzed to:

- Determine shark catch rates, disposition of caught sharks and costs and benefits from shark interactions to better understand longline industry interest in reducing shark interactions;
- Describe the range of longline industry attitudes towards shark capture and depredation to understand the degree of interest in shark avoidance;
- Identify practices employed by longline fishers in response to shark interactions;
- Identify promising concepts not currently practiced to reduce shark capture, reduce depredation and gear damage, improve discard methods, and determine what obstacles must be overcome to implement these concepts;
- Identify priority research and development, monitoring and management measures; and
- Identify economic, social and ecological effects of legislation affecting shark practices, assess if the legislation has resulted in reduced interest in capturing and retaining sharks, and discuss how these laws may have affected shark fishing mortality levels.

## Chapter 2

### Fishing Gear and Operational Characteristics

The scope of the 12 fisheries included in this study ranged from small-scale domestic artisanal fisheries to modern mechanized industrial fleets of distant water fishing nations. Some of these fisheries never target sharks and rarely retain caught sharks, while in other fisheries sharks are occasionally an important incidental catch species or can be an important target species.

Table 2.1 summarizes the general gear and operational characteristics of each fishery included in the study, focusing on parameters that are likely to affect shark interactions. For instance, the number of hooks in a basket, float line length and branch line length will affect the depth of baited hooks when soaking, which affects shark catch rates. The material used for the trace (leader) will affect shark retention on branch lines. The type of bait used will affect shark catch rates.

The information in Table 2.1 is intended to provide a generalized characterization of the gear of each fishery. However, for some parameters, there may be large variability in fishing gear and methods between vessels in a fleet and even for an individual vessel. For instance, some vessels in the Fiji longline tuna fleet fish at grounds within the Fiji Exclusive Economic Zone (EEZ), while larger vessels fish at grounds much more distant from their home port, on the high seas and in other nation's EEZs, and these two categories of vessels have substantial differences in the gear characteristics (Thomson, this volume). In some fisheries, vessels will seasonally substantially alter their gear when they change their primary target species (e.g., Chile and Peru artisanal longline mahi mahi and shark fisheries, Alfaro-Shigueto et al., this volume, Mangel and Alfaro-Shigueto, this volume; Japan offshore and nearshore pelagic longline tuna fisheries, Clarke, this volume). Gear characteristics may also vary substantially between seaports within a fishery (Mangel and Alfaro-Shigueto, this volume; Japan offshore and nearshore pelagic longline tuna fisheries, Clarke, this volume). Due to the large and diverse nature of the fleets, and because the information is not available in many cases, it is not practical to summarize the Japanese distant water, offshore and nearshore longline fisheries in Table 2.1. Available information for these fleets is presented in Appendix 5. The following is a summary of the main gear and operational characteristics of each fishery included in the study that affect shark catch rates:

- **Australia longline tuna and billfish fishery:** There are about 90 vessels, 15-30 m in length, in this year-round fishery. Trip length is typically four days or less. All but one of the vessels fish in waters off Australia's east coast. Hooks are set at depths between 33-77 m. Regulations prohibit the use of a wire leader on branch lines. A variety of fish species and squid are used for bait. About 11% of bait is caught by vessels and held aboard alive in circulating tanks for extended periods. Lightsticks are used. Gear soaks through the night.
- **Chile artisanal longline mahimahi and shark fishery and longline swordfish fishery:** (i) The artisanal fishery, with about 131 vessels with lengths  $\leq 18$  m, targets mahi mahi during the austral summer when mahi mahi is more available and has a higher value than sharks, and targets sharks throughout the year. Trip length varies by season with mahi mahi-targeting trips typically lasting three to four days. The artisanal fishery, when targeting sharks, is restricted to grounds along Chile's northern coast. Baited hooks are set at depths between 9-72 m. Wire leaders are used during the shark season. Bait species include sardine, mackerel and flying fish. Lightsticks are not used. Setting and hauling is conducted manually. Gear is set and soaks during the day. (ii) The industrial and artisanal swordfish fishery has 16 vessels with lengths ranging from 17-42 m. The fishery operates primarily from March to December. Vessels fish at grounds near Valparaiso and Concepcion at 80° W longitude, between 16-40° S latitude. Baited hooks are set at depths between 58-70 m. Wire leaders are typically used. Mackerel and squid are used for bait. Lightsticks are used. Gear soaks at night.
- **Fiji longline tuna fishery:** In 2006 there were 66 longline tuna vessels licensed to fish in Fiji's EEZ. All of the vessels are domestic Fiji flagged. These vessels are between 14-37 m in length. The

fishery operates year-round. Smaller vessels make trips lasting about 9 days, while larger vessels' trips last about 30 days. The smaller vessels fish at grounds within the Fiji EEZ while larger vessels fish on the high seas and in the EEZs of Vanuatu and the Solomon Islands. Baited hooks are set at depths between 50-300 m. Vessels do not use wire leaders. Vessels use sardine and pilchard for bait. Only larger vessels use lightsticks. Smaller vessels set gear in the early morning and haul in the afternoon. Larger vessels set gear in the morning and haul at night.

- **Italy Mediterranean industrial longline swordfish fishery:** The number of vessels in the Italy Mediterranean industrial longline swordfish fishery is not available. There are 569 Italian demersal and pelagic longline vessels operating in this region. Vessels participating in the Italian Mediterranean large-scale swordfish fishery operate from June-October. Trips are between seven and ten days long. Gear is set shallow, with baited hooks no deeper than 60 m. Wire leaders are not used. Vessels primarily use frozen mackerel for bait. Lightsticks are used. Gear soaks at night.
- **Japan distant water, offshore and nearshore longline fisheries:** In 2003 there were 504, 406 and 480 vessels in the distant water, offshore and nearshore longline fleets, respectively. Distant water vessels are > 120 mt, offshore vessels are 10-120 mt, and the smaller nearshore vessels are < 10 mt. All three fleets operate year-round. Distant water vessel fishing grounds range throughout the world's oceans on trips lasting two to three months. Offshore vessel trips last from one to four weeks, fishing at grounds east of Japan, generally west of 180° longitude. Nearshore vessel trips generally last from one to seven days and are based in coastal waters. Gear design and methods for all fleets vary with targeting strategy.
- **Peru artisanal longline mahi mahi and shark fisheries:** There are as many as 1,500 vessels operating in the fishery. Vessels are about 15 m long. Mahi mahi is the main target species during the austral summer. Sharks are target species from autumn to spring. Fishers target mahi mahi seasonally when this species is abundant in coastal waters. It is more profitable to target mahi mahi at this time of year relative to targeting sharks due to the shorter distance to fishing grounds and shorter trip length, with concomitant reduced costs for fuel and food, but the value of shark meat is usually  $\geq$  than that of mahi mahi. Vessels may travel up to 900 km from shore during the shark season. Mahi mahi trips typically last 5-7 days and shark trips last 15-20 days. Baited hooks are set at depths between 10-16 m. Wire leaders are not typically used during the mahi mahi season but are used during the shark season to maximize shark retention and reduce gear loss. Giant squid, mackerel and flying fish are used for bait. Lightsticks are not used. Gear soaks during the daytime.
- **South Africa longline swordfish and tuna fishery:** There are about 17 South Africa-flagged vessels in this fishery. In 2006 the fishery was divided into two sectors, where permits are now issued separately for vessels targeting tuna or swordfish. The domestic fishery primarily targets swordfish. Vessel lengths range from 19 - 56 m. The fishery operates year-round. Trips last about 14 days. Vessels fish at grounds off the West coast of South Africa mainly on the continental shelf. Hooks are set shallow, seldom deeper than 40 m. Wire leaders are prohibited. Squid is predominantly used for bait, with some fish bait (pilchard and mackerel) mixed in. Lightsticks are usually used. Gear soaks at night.
- **U.S. Hawaii longline swordfish and tuna fisheries:** In 2005 there were 125 active vessels in the Hawaii longline swordfish and tuna fisheries. Vessels are 10-31 m long. The tuna fishery operates year-round. The swordfish fishery is subject to annual turtle and effort caps, causing the fishery to occasionally close before the end of each calendar year. Tuna vessels make trips of about 21 days, fishing at grounds in the Western and central Pacific Ocean. Swordfish vessels make trips of about 30 days, fishing at grounds in the Eastern Pacific and Western and central Pacific Ocean. Tuna vessels set baited hooks at depths between 35-224 m, while swordfish vessels set hooks shallower, between 25-69 m. Most tuna vessels use a wire trace, use fish for bait and are prohibited from using lightsticks. Swordfish vessels do not use a wire trace, use fish for bait (squid is prohibited for use as bait to address sea turtle interactions), and use lightsticks. Tuna gear soaks during the day while swordfish gear soaks at night.

Table 2.1. Generalized gear characteristics that may affect shark interaction rates for nine pelagic longline fisheries.

Gear Characteristic	Pelagic Longline Fishery									
	Australia Tuna and Billfish	Chile Artisanal Mahi Mahi and Shark	Chile Swordfish		Fiji Tuna	Italy Mediterranean Industrial Swordfish	Peru Artisanal Mahi Mahi and Shark	South Africa Tuna and Swordfish	USA - Hawaii Tuna	USA - Hawaii Swordfish
			Spanish system	American -style						
Fishing season	All year	Sharks year-round, mahi in austral summer	March - December		All year	June – October	Shark season is March – November. Mahi mahi season is December - February	All year	All year	All year
Main line length	60 km	2.7 – 3.6 km	83 km	65 – 102 km	65-93 km	< 60 km	3-4 km	80 km	50 km	60 km
Main line deployment	Shooter	Manual	Manual		Not known	Manual	Manual	Manual	Shooter	Manual
Trip duration	4 days	3-4 days for mahi targeting trips			9-30 days	7-10 days	Mahi mahi trips are 5-7 days, shark trips are 15-20 days	10-15 days	21 days	30 days
Trips per year	Not available				Not known	12-16		Not available	15	12 <sup>1</sup>
Sets per trip	3				7-25	6-9	7-8 (mahi trips)	8-15	10	17
Hooks per set	950	100 - 350	1500	1200 - 2000	2300-2500	800 - 1400	600 - 2000	1000-1500	2000	800
Wire leader (trace) used?	No (prohibited)	No when targeting mahi, yes when targeting sharks	Yes or use poly-propylene	Yes	No	No	No when targeting mahi, yes when targeting sharks	No (prohibited)	Yes	No

Typical min depth of hooks	33 m	9 m	58 m	50-180 m	20 m	10 m	40 m	35 m	25 m	
Typical max depth of hooks	77 m	54 – 72 m	70 m	300 m	60 m	16 m	70 m	234 m	69 m	
Distance between buoys	360 m	18-36 m	4.5 km	Variable	90-700 m	150-300 m	15–30 m	200 m	800 m	500 m
Float line length	12 m	0 m	18 m	15-16 m	13-18 m	0 m	20 m	22 m	8 m	
Branch line length	19 m	9.1 m	8.2 m	16.5 m	15-24 m	18 m	10-16 m	20 m	13 m	17 m
Branch line material	Nylon monofilament	Nylon monofilament	Polypropylene	Nylon monofilament	Not known	Nylon monofilament	Nylon monofilament	Nylon monofilament	Nylon monofilament	Nylon monofilament
Hooks per basket (between buoys)	9		5-10	25-35	4-8	1 under each buoy	5	27	4	
Timing of soak	Variable	Day	Night	Day for small vessels, night for distant water vessels	Night	Day	Afternoon and night	Day	Night	
Lightstick frequency	Variable	None	1 -4 per hook	None on small vessels, yes on floats for large vessels	1 per hook	None	1 per hook	None (prohibited)	1 every 1-4 hooks	

Weight size and location	Variable, usually none	None when targeting mahi, weighted swivels when target sharks	60 g at connection of mainline and float line	80 g at connection of mainline and float line, and 65-76 g swivel at top of leader	Not known	None	None for mahi mahi; 46.2 g swivels located about 67 cm from the hook used in the shark season	60-80 g 2 m from hook	45-80 g within 1 m of the hook	0 to 80 g 5 to 7 m from hook (midpoint of the branch line)
Hook type	J and some circle hooks of various sizes	J 0,1,2,3 (10° offset)	J17 Ancora (no offset) J18 Ancora (no offset or 10° offset)	J Mustad 9 (10° offset)	Not known	J, Mustad (eye) 0-1	Mustad #2, #3, #4 J hooks 10 degree offset	J, size not available	Japan tuna 3.6 ring hook, 14/0, 15/0, and 16/0 circle hooks with 10 degree offset	18/0 circle hooks with a 10 degree offset
Bait type	Squid, pilchards, jack mackerel, yellowtail, scad, anchovy, redbait, blue and other mackerel, tooth whiptails, and redfish. (Live bait =11%)	Sardine, mackerel and flying fish	Squid and mackerel	Sardine, pilchard	Frozen mackerel	Squid, mackerel, flying fish	90% squid, 10% mix of pilchard and mackerel	Frozen mackerel, saury, sardine	Frozen mackerel, saury, sardine (squid is prohibited)	

<sup>1</sup> Since 2004 there has been an annual fishery-wide cap of 2,120 sets or until caps on turtle interactions are reached, whichever cap is reached first. In 2006 the fishery reached a cap on loggerhead sea turtles after 3 months. From 1991-2001 vessels targeting swordfish or a combination of swordfish and yellowfin tuna made a mean of 11.8 trips per year.

## Chapter 3

### Shark Catch Rates and Disposition

Table 3.1 summarizes the disposition of caught sharks for fisheries included in the study where this information is available. As discussed below, several of these entries are based on limited data from small sample sizes.

For the Japan distant water, offshore and nearshore longline fisheries, the shark catch rates reported in Table 3.1 are based on logbook data. These data are thus the number of sharks that are recorded in vessel logbooks but these figures' relationship to the actual number of sharks hooked and retained is expected to vary with logbook recording behavior (Clarke, this volume; Nakano and Clarke, 2006).

The Italy Mediterranean large-scale longline swordfish fishery is the only fishery included in this study where there is a lack of a local market for shark fins, and as a result, fishers do not fin sharks (Piovano, this volume).

The shark catch rates for the two Chile fisheries included in Table 3.1 are estimated from fisher interviews (Alfaro-Shigueto et al., this volume). Shark catch rates reported in the literature for the Chile longline swordfish fishery and artisanal longline mahi mahi and shark fishery are available only in weight per unit of effort (0.36 kg/hk and 0.28 kg/hk, respectively, 2005 (Barria and Donoso, 2006)), and not as number of sharks per unit of effort. In both fisheries, almost all caught sharks are retained (Alfaro-Shigueto et al., this volume). Blue and mako sharks are the main shark species caught. Carcasses and fins are usually retained, however, sometimes fins of blue sharks are only retained and carcasses are discarded, and occasionally sharks are released alive because they are small or to avoid contaminating the non-shark catch in the hold. For the Chile artisanal longline fishery during the mahi mahi season, vessels only retain shark carcasses that are caught during the last sets of a trip and only if space is available in the vessel hold. If the shark catch rate is high, blue shark carcasses may be discarded to make room for more valuable mako shark carcasses.

For the Fiji longline tuna fishery, observer data from 1999 and 2002 to 2005 show that 78 - 90% of caught sharks were finned and the carcasses discarded (Secretariat of the Pacific Community unpublished data reported in Thomson, this volume).

Statistics reported in Table 3.1 for the Peru artisanal longline mahi mahi and shark fishery are based on 2004 - 2006 onboard observer data taken only during the mahi mahi season from four ports for a total of 27 trips and 197 sets (Pro Delphinus, unpublished data; Mangel and Alfaro-Shigueto, this volume). The Peru artisanal longline fishery is similar to the Chile artisanal longline fishery in that almost all caught sharks are retained primarily for the sale of both their fins and meat (Mangel and Alfaro-Shigueto, this volume). Of 188 observed caught sharks, 30 were discarded (all released alive after retrieval of terminal tackle), 146 were retained whole, and fins only of 12 were retained (Pro Delphinus, unpublished data). Some fishers discard sharks smaller than about 50 cm long only when the shark is alive when hauled to the vessel (Mangel and Alfaro-Shigueto, this volume).

Table 3.1. Shark catch rate and disposition in 12 pelagic longline fisheries for the most current year for which data are available (Megalofonou et al., 2005; Alfaro-Shigueto et al., this volume; Brothers, this volume; Clarke, this volume; Gilman, this volume; Mangel and Alfaro-Shigueto, this volume; Petersen and Goren, this volume; Thomson, this volume).

<b>Pelagic Longline Fishery</b>	<b>Shark Catch Rate (Number per 1000 hooks)</b>	<b>Shark Retention (Fins and/or Carcass) (% of Total Number Caught Sharks)</b>
<b>Australia Tuna and Billfish Longline Fishery</b>	5.5 <sup>1</sup>	Not available
<b>Chile Artisanal Mahi Mahi and Shark Longline Fishery</b>	24 <sup>2</sup>	> 99 <sup>2</sup>
<b>Chile Longline Swordfish Fishery</b>	8 <sup>2</sup>	> 99 <sup>2</sup>
<b>Fiji Longline Tuna Fishery</b>	1.1	78-90
<b>Italy Mediterranean Industrial Longline Swordfish Fishery</b>	0.74	Not available
<b>Japan Distant Water Longline Tuna Fishery</b>	0.021 <sup>3</sup>	Not available
<b>Japan Offshore Longline Fishery</b>	0.175 <sup>3</sup>	Not available
<b>Japan Nearshore Longline Fishery</b>	0.020 <sup>3</sup>	Not available
<b>Peru Artisanal Longline Mahi Mahi and Shark Fishery during mahi season</b>	0.99	84
<b>South Africa Longline Tuna and Swordfish Fishery</b>	4.0	80
<b>USA - Hawaii tuna</b>	2.2	2.1
<b>USA - Hawaii swordfish</b>	16.7	0.2

<sup>1</sup> Rough estimate based on Australian Commonwealth Scientific and Research Organization unpublished data from a subset of the fleet and time period, possibly not representative (Brothers, this volume).

<sup>2</sup> Rough estimate based on interview responses.

<sup>3</sup> Based on number of sharks recorded in vessel logbooks (Clarke, this volume; Nakano and Clarke, 2006).

The large number of “not available” entries and entries based on rough estimates in Table 3.1 suggests either that there is insufficient data collection and management measures for shark species or that relevant data are collected but have not been analyzed. For fisheries where there is high confidence in available shark catch rates, these range from 0.7 to 17 sharks per 1000 hooks. The location of fishing grounds and characteristics of fishing gear and methods are likely primary factors determining a fleet’s shark catch rate. Certain gear designs (e.g., use of a wire leader, use of squid for bait, and depth of baited hooks) contribute to high shark catch rates. Shallow-setting pelagic longline fisheries generally have higher shark catch rates than deeper-setting fisheries.

The proportion of total catch comprised of sharks by number varies widely for the fisheries included in this study. In the Australia longline tuna and billfish fishery, sharks comprise about 27% of the total catch (Brothers, this volume). Observer data from 1999 found that sharks comprised > 25% of the total number of fish caught by Fiji longline tuna vessels (Swamy, 1999), while Secretariat of the Pacific Community observer program data for 1999 and 2002-2005 found that sharks comprised only 5.5% of the total number of caught fish (Thomson, this volume). From 1998-1999, sharks comprised about 18% of the



total catch in the Italy Mediterranean industrial longline swordfish fishery (Megalofonou et al., 2005). In the Peru artisanal longline mahi mahi and shark fishery, during the mahi mahi season in the port of Ilo for 2005-2006, sharks comprise less than 1% of the total catch by number (Mangel and Alfaro-Shigueto, this volume). In the South Africa longline tuna and swordfish fishery, from 1998-2005, sharks comprised 16.2% of the total number of caught fish (Petersen and Goren, this volume). In 2001, pelagic sharks comprised about 50% of the catch composition of swordfish sets and 16% for tuna sets in the Hawaii longline fishery (Ito and Machado, 2001). However, since 2004 the shark catch rate in the swordfish fishery dropped 36% when the fishery was required to switch from using J hooks with squid bait to wider circle hooks with fish bait (Gilman et al., 2006a).

The results from this study are generally consistent with the literature, which shows that a large quantity of pelagic sharks is taken as bycatch in pelagic longline fisheries with tuna and swordfish as their primary target species (Bailey et al., 1996; Williams, 1997; Matsunaga and Nakano, 1999; Swamy, 1999; Francis et al., 2001; Beerkircher et al., 2002). For example, in the western Pacific, shark species account for the highest category of bycatch in tropical fisheries, where sharks comprise 27% of total bycatch, and in subtropical fisheries, where sharks are 18% of total bycatch (Bailey et al., 1996; Heberer and McCoy, 1997). In the U.S. Atlantic longline swordfish and tuna fisheries, sharks and rays constituted 25% of total catch between 1992 and 2003 (Abercrombie et al., 2005). Beerkircher et al. (2002) found that sharks comprised 15% of the total catch, comprised of 22 elasmobranch species, in the southeastern U.S. pelagic longline swordfish and tuna fisheries. Bonfil (2002) found that the same numbers of sharks are caught in directed fisheries as are caught as bycatch mostly in longline tuna fisheries. However, the recent development of longline directed shark fisheries, especially in the Pacific, may mean that directed shark fisheries are now catching more sharks (Chen et al., 2002; Stevens, 2002; Catarci, 2004; FAO, 2006; Alfaro-Shigueto et al., this volume; Mangel and Alfaro-Shigueto, this volume).

For fisheries where information on shark catch composition is available, blue sharks comprise the largest proportion of shark catch. Blue sharks comprise 47% of total shark catch by number of fish in the Australia longline tuna and billfish fishery (Brothers, this volume); 49% in the Fiji longline tuna fishery (Thomson, this volume);  $\geq 70\%$  of total shark catch by number for Japan longline fisheries (Clarke, this volume); 57% for the Peru artisanal mahi mahi and shark longline fishery (Pro Delphinus, unpublished data); 69% for the South Africa longline tuna and swordfish fishery (Petersen and Goren, this volume); and 82% and 92% for the U.S.A. Hawaii longline tuna and swordfish longline fisheries, respectively (Gilman, this volume).

Identifying effective and commercially viable methods to reduce unwanted shark bycatch in longline fisheries would contribute to reducing shark fishing mortality. Increasing discards of blue sharks in pelagic longline fisheries would likely reduce fishing mortality of this species, as blue sharks are usually alive when hauled to the vessel (Beerkircher et al., 2002; Gilman, this volume; Mangel and Alfaro-Shigueto, this volume; Thomson, this volume). Beerkircher et al. (2002) found that the condition of sharks caught in pelagic longline gear (dead versus alive when hauled to the vessel) varied widely by species, where for example, blue sharks had a relatively low 12.2% mortality, while silky sharks (the most dominant species of shark by number caught in the observed southeastern U.S. pelagic longline swordfish and tuna fisheries, 31.4% of elasmobranch catch) had a 66.3% mortality. Gilman (this volume) found that over 89% of sharks caught in the Hawaii-based longline swordfish fishery and over 93% of sharks caught in the Hawaii-based longline tuna fishery are alive when the gear is retrieved. Mangel and Alfaro-Shigueto (this volume) found that 87% of sharks caught in the Peru artisanal mahi mahi and shark longline fishery were alive when gear was retrieved. Thomson (this volume) analyzes Secretariat of the Pacific Community observer program data from 2002-2005 for the Fiji longline tuna fishery and found that over 94% of blue sharks and over 84% of combined species of sharks were alive when hauled to the vessel.

## Chapter 4

### National and International Measures

#### 4.1. Summary and Effects of National/EC Legislation on Shark Interactions

Table 4.1 summarizes legally binding measures that influence longline industry practices and attitudes towards shark bycatch and depredation in pelagic longline fisheries. The two Chile longline fisheries, Fiji longline fishery, and three Japan longline tuna fisheries are not subject to legally binding measures that manage shark interactions, and are not included in Table 4.1. However, Japan and Fiji distant water longline tuna vessels may comply with voluntary measures adopted by Regional Fishery Management Organizations, and vessels operating in EEZs of other nations through foreign license access agreements may be required to comply with restrictions on shark catch, retention and use under these access agreements.

Legislation prohibiting the removal of shark fins and tail and discarding the remainder of the shark at sea in pelagic longline fisheries exists in four of the eight countries included in this study (Australia, Italy, South Africa, and U.S.A.) (Commonwealth of Australia, 1991; South Africa Marine Living Resource Act of 1998; U.S. Congress, 2000; Council of the European Union, 2003). In the Australia longline tuna and billfish fishery, a rule that disallows possession, carrying and landing of shark fins unless attached to the trunk of the shark has likely substantially reduced shark fishing mortality, as finning was a widespread practice before this measure was instituted, while about 75% of caught sharks are now released alive (Rose and McLaughlin, 2001; Hobday et al., 2004). In the Hawaii longline tuna and swordfish fisheries, observer data indicate that the restriction on shark finning, which requires the retention of shark carcasses for corresponding retained fins, has likewise substantially reduced shark fishing mortality. As many as 76% and 64% of caught sharks were finned in the Hawaii tuna and swordfish fisheries, respectively, prior to this rule being in effect, while in 2006 91% and 93% of caught sharks were released alive in the tuna and swordfish fisheries, respectively. In the South Africa longline tuna and swordfish fishery, all interviewed fishers stated that prior to the finning restriction, they would fin and discard the carcass of all caught sharks excluding makos, which were retained for the sale of both their fins and meat. Thus, as in the case in the Hawaii and Australia longline fisheries, the restriction on finning in South Africa has substantially reduced shark retention and increased discards. In these fisheries, shark finning restrictions have caused substantial reductions in revenue to industry. For instance, revenue from shark fins had comprised 10-11% of Hawaii longline crew salaries (McCoy and Ishihara, 1999).

Italy is subject to European Union Council Regulation No 1185 (Council of the European Union, 2003), which prohibits the practice of shark finning. However, all 17 interviewed owner-operators from the Italy Mediterranean industrial longline swordfish fishery were unaware of the prohibition and thus the legislation does not affect their practices. However, no shark finning is reported to occur in the fishery due to the lack of a local market for the fins.

Japan does not have legislation restricting shark finning practices, however, the distant-water fleet fish in EEZs of nations that do have finning restrictions (e.g., South Africa, Brazil, Costa Rica). Vessels in the Japan distant-water longline tuna fishery will likely fin caught sharks and discard the carcass unless they are fishing in the EEZ of a nation that prohibits this practice, in which case the vessel may choose to retain the whole shark carcass and land the carcass in ports where there are markets for shark meat. Thus, Japanese longline fishermen have adapted to finning regulations applicable in some areas by landing sharks in recently developed local markets rather than by attempting to avoid shark interactions. In waters without finning regulations, including Japanese waters and the North Pacific, sharks are either finned or landed whole, and in either case the ability to sell shark products has contributed to a lack of interest in reducing shark bycatch.

A 20 shark carcass per trip limit for the retention of sharks in the Australia East coast longline tuna and billfish fishery has not altered the number of sharks retained by fishers, as fewer than 20 sharks are typically caught during an average length trip, and only a small proportion of the sharks caught on a trip are of species (makos and threshers) for which there is sufficient value for their meat. Furthermore, many operators in this fishery will only retain a shark that is of a marketable species if it is dead or dying when hauled to the vessel, which can be safely and relatively easily landed.

The South Africa longline tuna and swordfish fishery is subject to a shark landing limit of 10% of the total swordfish and tuna catch. This theoretically has been economically detrimental to the industry. From 1998-2005, the total number of caught sharks was 18% of the total number of caught swordfish and tunas. Thus, vessels would need to discard about 44% of their caught sharks to comply with the shark limit. Because only about 18% of caught blue sharks and 10% of makos have been observed to be released alive in this fishery, and the literature demonstrates that a much larger proportion of these shark species (>85%) are likely alive when hauled to the vessel (e.g., Beerkircher et al., 2002), it is likely that fishers are not complying with this measure.

A prohibition on the use of a wire trace in the Australian longline tuna and billfish fishery and South Africa longline tuna and swordfish fishery has likely resulted in an increased economic cost from shark interactions as this has likely caused an increase in the loss of terminal tackle to sharks. A substantially larger number of hooks, bait and line are likely now bitten off of branch lines compared to when wire trace was used. However, fishers generally do not consider this to be a large concern. It is not known how the injury to sharks from retaining hook and trailing monofilament line affects their survival prospects. This is a research priority. This may be an improvement to their previous fate when caught on lines with wire trace when they would soak on the gear for hours, be gaffed and hauled onboard the vessel and then have hooks removed by cutting with a knife or pulled out by force. Available but limited information indicates that a large proportion of sharks caught in longline gear that are released after removal of the hook will survive (Section 6.2.4; U.S. National Marine Fisheries Service, 2005). In fisheries where a large proportion of caught sharks is killed either for retention or discarding, prohibiting the use of wire leaders will almost definitely reduce shark fishing mortality. Prohibiting wire leaders may exacerbate seabird bycatch problems: Fishers will be less likely to attach weights close to hooks on branch lines lacking a wire leader due to safety concerns, thus, reducing the baited hook sink rate, and increasing seabird catch rates.

Shark fisheries in Peru are regulated by the Ministry of Fishery through size limits for certain elasmobranch species (Diario Oficial El Peruano, 2001). However, there is little enforcement of these regulations and few fishers are aware that the regulations exist (Alfaro and Mangel, 2002). Of the few interviewed fishers who reported that they were aware of the regulations (5%), all report that they still retain sharks that are under the minimum size limit.

Table 4.1. Legal framework that influence practices and attitudes towards shark bycatch and depredation in six pelagic longline fisheries (Commonwealth of Australia, 1991; Diario Oficial El Peruano, 2001; Council of the European Union, 2003; U.S. National Marine Fisheries Service, 2002, 2005).

Pelagic Longline Fisheries by Flag State	Legal Constraints <sup>1</sup>				Size Limit
	Retention of Fins Requires Retention of Corresponding Carcass <sup>2</sup>	Shark Retention Limit <sup>3</sup>	Prohibit Wire Trace	Prohibit Retention of Specified Shark Species	
Australia tuna and billfish	X	X	X	X	
Italy Mediterranean industrial swordfish	X				
Peru artisanal mahi mahi and shark					X
South Africa tuna and swordfish	X	X	X		
USA - Hawaii tuna	X				
USA - Hawaii swordfish	X				

<sup>1</sup> Japan and Fiji distant water longline tuna vessels may comply with voluntary measures adopted by Regional Fishery Management Organizations, and vessels operating in EEZs of other nations through foreign license access agreements may be required to comply with restrictions on shark catch, retention and use under these access agreements.

<sup>2</sup> U.S.A., Italy (European Union), and South Africa require the total weight of retained shark fins to be  $\leq 5\%$  of the total dressed 'live' weight of shark carcasses (South Africa Marine Living Resource Act of 1998; Council of the European Union, 2003; U.S. National Marine Fisheries Service, 2002, 2005).<sup>3</sup> Australia requires fins to be attached to the shark carcass when landed (Commonwealth of Australia, 1991).

<sup>3</sup> Australia has a 20 shark carcass per trip retention limit for longline tuna and billfish fisheries (Commonwealth of Australia, 1991). South Africa has a shark landing limit of 10% of the total swordfish and tuna catch (Petersen and Goren, this volume).

## 4.2. International Initiatives Addressing Shark Finning

There have been several recent international initiatives addressing shark finning. Fisheries subject to restrictions on finning sharks are expected to have a high incentive to avoid shark interactions. A summary of international initiatives related to shark finning follows.

- **Food and Agriculture Organization of the United Nations:** In 1999 the Food and Agriculture Organization of the United Nations (FAO) endorsed the International Plan of Action for the Conservation and Management of Sharks. This is a non-legally binding voluntary initiative calling on States to ensure the conservation and management of sharks, including by minimizing waste and discards from shark catches such as through requiring the retention of sharks from which fins are removed (FAO, 1999b).
- **International Commission for the Conservation of Atlantic Tunas:** In November 2004, the International Commission for the Conservation of Atlantic Tunas (ICCAT) adopted with consensus a binding measure requiring full utilization of shark catches (fishers must retain all parts of the shark except the head, guts, and skins to the point of first landing) and prohibiting vessels in ICCAT

<sup>3</sup> The Council of the European Union (2003) Regulation No. 1185, adopted in conjunction with the European Parliament, is legally binding in all Member States of the European Union, without any further action needed on the part of the national authorities, i.e., there is no need for Member States to adopt national enabling instruments to make the measure legally binding in their fisheries. In September 2006, the European Parliament passed a Resolution (a non-binding instrument) on the application of Regulation 1185/2003, which calls on the Commission of the European Union to present to the European Parliament and the Council no later than 30 June 2007 a Community Plan of Action for the conservation of sharks and seabirds, and to review the appropriateness of the Regulation's shark fin to carcass dressed weight ratio (European Parliament, 2006).

fisheries from retaining on board, transshipping, or landing any shark fins that are taken in contravention of the measure. Countries must ensure that their vessels retain fins totaling no more than 5 percent of the weight of sharks onboard up to the first point of landing, or otherwise must ensure compliance with the ratio through certification, monitoring, or other means.

- **United Nations General Assembly:** In November 2004, the United Nations General Assembly adopted by consensus a resolution on Oceans and the Law of the Sea *Sustainable Fisheries, including through the 1995 Agreement*, which includes a provision that discourages shark finning, calls for implementation of the FAO International Plan of Action on sharks, and invites FAO to study the impact on shark populations of shark catches from directed and non-directed fisheries.
- **International Union for Conservation of Nature and Natural Resources:** In November 2004, the International Union for Conservation of Nature and Natural Resources (IUCN) adopted a recommendation urging all States to ban shark finning and require shark fins to be landed attached to their bodies.
- **Inter-American Tropical Tuna Commission:** In June 2005, the Inter-American Tropical Tuna Commission (IATTC) adopted a *Resolution on the Conservation of Sharks Caught in Association with Fisheries in the Eastern Pacific Ocean*, which bans shark finning and mandates the collection of information and advice on stock status of shark species. The resolution also requires members to comply with the FAO International Plan of Action on sharks and take measures to require that their fishers fully utilize any retained sharks.
- **North Atlantic Fisheries Organization:** In September 2005, the North Atlantic Fisheries Organization (NAFO) adopted a resolution modeled after the IATTC and ICCAT measures, banning shark finning in all NAFO-managed fisheries, and mandated the collection of information on shark catches.

### 4.3. Conclusions on Data Collection and Management Frameworks

Most national fishery management authorities of the 12 fisheries included in this study demonstrate a low priority for monitoring and managing chondrichthyan fishes, consistent with the results of a global review by Shotton (1999). Few regional fishery management organizations are using fishery-dependent data to conduct shark stock assessments (only the International Commission for the Conservation of Atlantic Tunas, for blue and shortfin mako sharks in the North and South Atlantic (Anonymous, 2005)). Sustainable management of chondrichthyan populations is hampered by this general lack of fishery-dependent data and management measures for sharks (Musick, 2005). The expanding exploitation of sharks, for their fins as well as meat, largely in the absence of management frameworks and the lack of reliable fishery-dependent data and fundamental understanding of the biology of most shark species' warrant concern for the health of shark populations as well as ecosystem-level effects from population declines. Approaches to sustainably manage cartilaginous fishes will necessarily differ from traditional fishery management methods for teleosts due to cartilaginous fishes' relatively low reproductive potential (Stevens et al., 2005).

There are few fisheries with measures to manage shark catch levels. Clarke (this volume) and Mangel and Alfaro-Shigueto (this volume) identify growing markets for shark meat at several ports worldwide (Chapter 5, Section 5.1). This trend toward more utilization of shark meat may be beneficial in the short term in that fully utilized sharks are more likely to be reported in logbooks and landings statistics than are the retention and landing of just shark fins. However, if the shark meat market continues to grow, this could increase shark catch rates and fishing mortality. Existing finning prohibitions do not manage the number of sharks that are killed. Thus, to prepare for a possible increase in demand for shark meat fishery management authorities are encouraged to institute data collection, monitoring and precautionary management measures to ensure that shark catches are sustainable.

## Chapter 5

### Economic, Practical, Ecological and Social Problems from Shark – Longline Interactions

#### 5.1. Economic and Practical Concerns

Shark interactions in pelagic longline fisheries result in substantial inconveniences and adverse economic effects, including:

- (vi) **Depredation.** Lost revenue from shark damage to target species can amount to several thousand U.S. dollars in a single set in some fisheries (Fig. 5.1).
- (vii) **Damage and loss of gear.** Sharks bite off terminal tackle (e.g., baited hook, leader, weighted swivel, and line) from branch lines, stretch and chafe branch lines, break the main line, and some shark species will pull the gear down causing branch lines to become entangled.
- (viii) **Reduced catch of marketable species.** When baited hooks are occupied or removed by sharks, there are fewer hook available to catch non-sharks marketable species;
- (ix) **Risk of injury.** It is dangerous for crew to handle caught sharks and there is a risk of being hit by weights when branch lines containing sharks break during gear retrieval; and
- (x) **Expenditure of time.** A majority of fishers consider the time required to remove sharks from gear, retrieve terminal tackle and repair and replace gear as a central concern resulting from shark interactions.



Fig. 5.1. Shark-damaged yellowfin tuna (left) and bigeye tuna caught in the Hawaii pelagic longline fisheries (photos courtesy of U.S. National Marine Fisheries Service Hawaii Pelagic Longline Observer Program).

In fisheries where there is demand for shark products, where vessels continuously or periodically target sharks, fishermen generally perceive these costs to be a minor inconvenience and are not problematic enough to create an incentive to avoid sharks. However, in fisheries with restrictions on finning, a lack of market for shark meat, or a per-trip limit on shark retention, where shark catch rates are relatively high, shark interactions are perceived to be a major inconvenience and represent a substantial economic cost.

In the Australia longline tuna and billfish fishery, fishermen estimate that they lose 20% of their catch of target species due to shark damage, while damage and loss of gear from shark interactions amounts to a loss of about AUD 100 per set. Considerable time is also expended to discard caught sharks. The average catch rate of sharks is about 5.5 sharks per 1000 hooks compared to the catch rate of target and incidental fish of about 20.5 fish per 1000 hooks. However, on a given set, the shark catch can be extremely high (hundreds of sharks) resulting in great cost.

Fishers in the Chile mahi mahi and shark fishery and swordfish fishery report that sharks are an important target or incidental catch species. In the Chile fisheries, fishers perceive that revenue from catching sharks exceeds costs from shark interactions. In a typical mahi mahi set, costs from the loss and damage to gear is about USD 18.5 and in the swordfish fishery 50-100 branchlines are damaged from shark interactions on a typical set. Fishermen reported having an average of 5.5 mahi mahi and 3.3 swordfish damaged from shark depredation on a typical set in the artisanal mahi mahi fishery and swordfish fishery, respectively. This represents a loss of about USD 146 per mahi mahi set and USD 1,063 per swordfish set.

In the Fiji longline tuna fishery, almost all caught sharks are finned (Table 3.1) and carcasses are usually discarded. Shark carcasses are infrequently retained because of the low value of shark meat. Survey respondents generally perceive that costs from shark interactions, including economic costs and time spent to deal with the interactions, exceed the revenue from shark fins. However, all interview respondents stated that the cost from gear damage and loss from sharks and loss and damage of target species and bait is nominal. The general opinion of the interviewees was that while sharks provide an important source of income for crew, the time lost in processing the sharks and the lost bait and target species exceeds the benefit from the income generated.

In the Italy Mediterranean industrial longline swordfish fishery, where the shark catch rate is low and sharks are occasionally retained for the sale of meat, fishermen find the costs from shark interactions to be a minor inconvenience. Few (0 - 10) branch lines are damaged or lost to sharks on a typical set, and very rarely is a target species damaged by sharks, and at most two target species are damaged by sharks per set. However, despite the perceived low frequency of shark interactions and nominal economic cost from these interactions, fishermen believe that the revenue from catching sharks is exceeded by costs from shark interactions, and there is some concern over the safety risk of handling caught sharks. As a result fishermen in this fishery are interested in reducing shark interactions as long as this does not adversely affect their catch rate of target species (Piovano, this volume).

In Japanese longline fisheries, where fins are retained from the majority of caught sharks and in some cases carcasses are retained for their meat, costs of shark interactions are perceived to be minor. Gear damage and loss from shark interactions is considered a much less important problem than shark damage to hooked tunas and billfishes, which can result in the damage of as many as three fish per set, where shark depredation of one fish every 3-5 sets is more typical (Clarke, this volume).

Fishers in the Peru artisanal mahi mahi and shark longline fishery also report that the revenue from catching sharks exceeds costs from shark interactions, and that sharks are an important incidental catch species during the mahi mahi season, and the main target species the remainder of the year. Fishers estimate that they incur a cost of USD 11 per set due to damage and loss of gear, and have an average of about USD 30 from 7.5 mahi mahi being damaged from sharks on a typical set from shark interactions during the mahi mahi season.

In the South Africa longline tuna and swordfish fishery, fishers report that shark damage to their gear and the loss of bait from shark interactions is a concern. On average, they will lose the terminal tacks of between 10-30 branch lines, although this is highly variable from set to set. On typical sets, 2 to 5 commercially valuable fish are damaged or lost to sharks.

In the U.S. Hawaii longline swordfish fishery, where > 99% of caught sharks were discarded in 2006 when the shark catch rate was 16.7 sharks per 1000 hooks (the catch rate of retained fish is about 23 fish per 1000 hooks), and in the Hawaii longline tuna fishery, where > 97% of caught sharks were discarded in 2006 when the shark catch rate was 2.2 sharks per 1000 hooks (the catch rate of retained fish is about 13 fish per 1000 hooks), fishermen perceive the time required to remove sharks from gear and to rebuild damaged and lost gear to be a substantial inconvenience (Gilman et al., 2006a; Gilman, this volume). Crew will rebuild all branch lines on which sharks are caught. Caught sharks stretch the line and chafe the line from contact with their skin, weakening it so that there is a risk of losing a caught fish on a subsequent set if the gear were not rebuilt. Risk to injury of crew from caught sharks is also identified as a substantial concern. Economic costs from the damage and loss of gear is nominal, costing an

estimated USD 19 and 50 per typical tuna and swordfish targeting set, respectively. Fishers report having an average of three commercially valuable fish species damaged from shark bites on a typical longline tuna set and five commercially valuable fish species damaged on a typical swordfish set. This can represent a loss of several thousands of dollars depending on the size and species of fish that are damaged. On an especially bad set, as many as 50% of target species may be damaged to a degree that they cannot be sold. Fishermen would want to minimize shark interactions even lacking restrictions on finning sharks, citing the risk of crew injury and that their revenue from catching sharks would still not become an economic advantage (Gilman, this volume).

Many pelagic longline fisheries targeting species other than sharks, when not prevented by regulation, will retain the fins of captured sharks, which fetch a high value in the Asian dried seafood trade, and occasionally will retain meat and other parts (cartilage, liver oil, skin) from marketable species of sharks when markets for these products are available (e.g., Williams, 1997; McCoy and Ishihara, 1999; Francis et al., 2001; Clarke et al., 2006; Alfaro-Shigueto et al., this volume; Clarke, this volume; Mangel and Alfaro-Shigueto, this volume). High demand for shark fins in Asia means that few sharks caught in pelagic longline fisheries where finning is not prohibited or resources for enforcement are scarce are released alive (Williams, 1997; Francis et al., 2001). For instance, from 1995-1999, before restrictions on shark finning were instituted, the Hawaii-based longline swordfish fishery finned 65% of caught sharks, when about 50% of the catch by number was elasmobranch bycatch. In the Fiji longline tuna fishery, 78-90% of caught sharks are finned (Secretariat of the Pacific Community, unpublished data). Francis et al. (2001) found that about half of the catch by number on New Zealand tuna longlines was elasmobranch bycatch, primarily blue sharks (*Prionace glauca*), porbeagles (*Lamna nasus*) and shortfin makos (*Isurus oxyrinchus*). Most of the shark bycatch was processed but with usually only the fins retained (Francis et al., 2001). Williams (1997) found that in western and central Pacific longline tuna fisheries, the fate of shark bycatch was species-specific: Certain species, such as pelagic stingray, were always discarded whole, while trunks of silky and blue shark were occasionally retained (45.8% and 5.4% of the time, respectively), fins of blue sharks were retained most of the time (84.1% of the time), and fins of silky sharks were retained about half (47.5%) of the time. In some fisheries, shark discarding and retention practices are also a result of the value of the species of caught shark, whether the shark is caught at the beginning or end of a fishing trip, how much hold space remains, whether or not the shark is alive or dead when hauled to the vessel and the size of the shark.

However, to address the social concern that shark finning is wasteful when a large portion of the shark is discarded, and ecological concerns over the sustainability of shark exploitation in fisheries, there have been several recent international initiatives and adoption of national legislation addressing shark finning (Chapter 4). Fisheries that are required to retain and land entire shark carcasses if they wish to retain the fins have a high economic incentive to avoid shark bycatch in areas where there is a lack of markets for shark meat. Some fisheries may lack access to markets for shark products, creating a large incentive to avoid shark bycatch (Piovano, this volume). Vessels in these fisheries may opt to fill their hold with more commercially valuable species.

There are pelagic longline fisheries where revenue from sharks exceeds costs from shark interactions, a large proportion of caught sharks are retained, and sharks are either always an important target species, are targeted seasonally or at certain fishing grounds proximate to ports where there is demand for shark fins and meat, or are an important incidental catch species (Buencuerpo et al., 1998; Alfaro-Shigueto et al., this volume; Clarke, this volume; Mangel and Alfaro-Shigueto, this volume). For instance, sharks comprised 70% of landings by the Spanish North Atlantic and Mediterranean longline swordfish fishery in 1991-1992 based on sampling at the Algeciras fish market in southern Spain (Buencuerpo et al., 1998). While the majority of pelagic longline fisheries target tunas and billfishes (Brothers et al., 1999), there are a growing number of pelagic longline fisheries where the main target species are pelagic or coastal sharks (Fig. 5.2) (e.g., Bonfil, 2002; Chen et al., 2002; Stevens, 2002; Catarci, 2004; FAO, 2006; Alfaro-Shigueto et al., this volume; Clarke, this volume; Mangel and Alfaro-Shigueto, this volume). While some directed shark fisheries are large industrial practices, the majority of shark catches comes from small-scale primarily gillnet fisheries from around the world (Reyes, 1993; Bonfil, 2002). Chondrichthyan fisheries have substantially grown in developing countries over the past several decades. Developing countries' shark catches increased from 76,000 to 575,031 metric tons from 1950 to 2000 for a value in



the year 2000 of USD 515 million (Catarci, 2004; FAO, 2006). From 1985 to 2000, elasmobranch catches reported to the Food and Agriculture Organization of the United Nations have increased annually by an average of 2% (FAO, 2002). However, actual elasmobranch catches are likely much higher than reported due to a lack of accurate data collection programs and to purposeful underreporting (Clarke et al., 2005, 2006).



Fig. 5.2. Sharks landed by vessels of a Japanese pelagic longline shark fishery, Kesenuma, Japan.

Crew in many pelagic longline fisheries have a strong economic incentive to catch sharks and fin as many of the sharks that are caught as possible as they receive the proceeds from shark fins (Williams, 1997; McCoy and Ishihara, 1999). For instance, Williams (1997) reported that crew of some longline tuna vessels operating in the western and central Pacific obtain half of their wage from shark fin revenue. McCoy and Ishihara (1999) estimated that Hawaii longline crew had obtained over 10% of their annual wage from shark fin sales, prior to the promulgation of rules placing restrictions on shark finning practices.

Results from this study reveal that there has been a large increase in the demand for shark fins and meat and catch of sharks over the past several decades, and demand for shark meat may continue to increase (Williams, 1997; McCoy and Ishihara, 1999; FAO, 2006; Alfaro-Shigueto et al., this volume; Clarke, this volume; Mangel and Alfaro-Shigueto, this volume). For instance, shark catch by weight in Chile fisheries has increased an order of magnitude from about 1000 tons in 1950 to over 10,000 tons in 2005 (FAO, 2006). Also, the shark catch in Peruvian fisheries and export market for frozen shark meat has grown, where the revenue from shark meat exceeds revenue from fins on a per-trip basis for a vessel in the Peru artisanal mahi mahi and shark longline fishery (Mangel and Alfaro-Shigueto, this volume). From 2000 to 2005 exports of shark meat from Peru tripled, with main export markets including Uruguay, Spain, Brazil and Colombia (PROMPEX, 2006; Mangel and Alfaro-Shigueto, this volume). Clarke (this volume) identifies a trend in expanding demand for shark meat in a few regions in Japan where offshore and nearshore vessels land their catch as well as at several foreign seaports where distant water longline vessels land their catch, including Cape Town (South Africa), Callao (Peru), Las Palmas (Spain), Balboa (Panama), Cartagena (Venezuela) and Port Louis (Mauritius), and a concomitant increase in retention and landing of shark carcasses by the Japan longline fisheries. The shark meat landed in Callao, Cape Town and Las Palmas may be exported to European markets in Italy and Spain (Clarke, this volume).

## 5.2. Ecological Concerns

There is an ecological basis for concern over shark interactions in pelagic longline fisheries. In the last decade, as elasmobranch catches have increased in both directed and incidental fisheries, there has been increasing concern about the status of some shark stocks, the sustainability of their exploitation in

world fisheries, and ecosystem-level effects from shark population declines (e.g., FAO, 1999b; Bonfil, 2002; Baum et al., 2003; Baum and Meyers, 2004; Ward and Meyers, 2005).<sup>4</sup> Most shark species are predators at the top of the food chain and characterized by relatively late maturity, long life, slow growth, low fecundity and productivity (small and infrequent litters), long gestation periods, high natural survivorship for all age classes, and low abundance (K-selected life history strategies) relative to bony fish such as tunas and billfishes and to organisms at lower trophic levels (Fowler et al., 2005). Some shark species may also aggregate by sex, age and reproductive stage (Heberer and McCoy, 1997; Cailliet et al., 2005). These life history characteristics make sharks particularly vulnerable to overexploitation and slow to recover from large population declines (Musick et al., 2000; Cailliet et al., 2005). Directed shark fisheries in North America provide examples of overfishing and population declines, such as occurred in directed fisheries for the porbeagle (*Lamna nasus*) (Casey et al., 1978), soupfin shark (*Galeorhinus zyopterus*) (Ripley, 1946), and spiny dogfish (*Squalus acanthias*) (Rago et al., 1998). Also, for example, the lack of monitoring of primarily discarded bycatch of the barndoor skate (*Dipturus laevis*) in the western North Atlantic bottom trawl fisheries resulted in a large population decline (Musick, 2005).

The main threats faced by chondrichthyans are various fishing activities and habitat degradation and loss (Stevens et al., 2005). Reviews of assessments of the threatened status of sharks and related taxa undertaken to date indicate that the taxa at highest risk include commercially exploited species of deepwater sharks, species restricted to freshwater and brackish water habitats and coastal endemics whose entire range overlaps with fishing effort (CITES, 2003). However, a lack of both fundamental biological information and fishery-dependent data for most shark species (Cailliet et al., 2005; Musick, 2005) means that there is a high degree of uncertainty in the status of these species. The biology of the chondrichthyan fishes is the least understood of all the major marine vertebrate groups, where detailed information on life history and reproductive dynamics is not available for all but a few of species important for directed fisheries (Cailliet et al., 2005). There is a general lack of reliable and sufficiently detailed fishery-dependent data on shark species to enable sustainable management (Shotton, 1999; Musick, 2005). Pelagic longline fisheries operating on the high seas are not likely interacting with these shark species identified as highest-risk, while some coastal pelagic longline fleets could be catching at-risk coastal endemics. In particular, blue sharks (*Prionace glauca*), the dominant species of shark caught in most pelagic longline fisheries operating on the high seas (e.g., Williams, 1997; Francis et al., 2001), are less vulnerable to overfishing relative to other shark species due to their being relatively prolific and resilient (Smith et al., 1998; Cortes, 2002). Blue sharks comprise the largest proportion of shark species caught in all 12 of the fisheries included in this study, ranging from 47% - 92% of shark catch in fisheries where this information is available. Kleiber et al. (2001) conducted a stock assessment of blue sharks in the North Pacific and concluded that blue sharks are not being overfished in the North Pacific. However, more recent research by Clarke et al. (2006) suggests that blue sharks globally are being captured at levels close to or possibly exceeding maximum sustainable yield. Clarke et al. (2006) estimated global shark catches using shark fin trade records, and found that shark biomass in the fin trade is three to four times higher than shark catch figures reported by the Food and Agriculture Organization of the United Nations, which is the sole existing global database. Additional stock assessments for other pelagic sharks have been conducted only by the International Commission for the Conservation of Atlantic Tunas for blue and shortfin mako sharks in the North and South Atlantic (Anonymous, 2005).

---

<sup>4</sup> Atlantic blue sharks are among those species reported to have undergone considerable population declines (Baum et al., 2003). Consistent with previous arguments against treating CPUE as an index of abundance (Cooke and Beddington, 1984), the reported blue shark decline (~60% since 1986) postulated by Baum et al. (2003) has been questioned by several authors (e.g. Burgess et al., 2005a,b; Campana et al., 2005) on the basis that potential reasons for drops in CPUE aside from abundance declines were not accounted for, such as underreporting, changes in fishing grounds and changes in fishing gear such as not using wire leaders (Brooks et al., 2005). It is acknowledged, however, that the species has likely endured some level of decline in recent years (Brooks et al., 2005; Campana et al., 2006).

### **5.3. Social Concerns**

Shark finning, where fins from caught sharks are retained and the remainder of the carcass is discarded, raises the social issue of waste. This has received recent international and national (Commonwealth of Australia, 1991; South Africa Government, 1998; Diario Oficial El Peruano, 2001; Council of the European Union, 2003; U.S. National Marine Fisheries Service, 2002, 2005) attention. Concern has also been raised that finning practices are cruel to sharks based on the presumption that fishers remove fins and discard sharks alive. However, results from this study document that, in all fisheries where shark finning occurs, to avoid injury and increase efficiency, crew first kill the fish before removing fins, and do not remove fins from live sharks. Also, discarded bycatch in general raises the social issue of waste (Alverson et al., 1994; Hall et al., 2000; FAO, 1999c), however, in the case of shark discards, available information suggests that in pelagic longline fisheries, shark post release survival prospects are high (U.S. National Marine Fisheries Service, 2005) and most sharks caught in pelagic longline fisheries are alive when hauled to the vessel (Williams, 1997).

## **Chapter 6**

### **Industry Attitudes and Practices**

#### **6.1. Industry Attitudes**

Table 6.1 summarizes predominant attitudes related to shark depredation and bycatch possessed by fishers of 12 pelagic longline fisheries. The existence of restrictions on shark finning and shark retention limits (Table 4.1) has a large influence on industry attitudes towards shark interactions in the Australia, South Africa, and Hawaii, U.S.A. longline fisheries, where legal constraints have caused shark interactions to be an economic disadvantage. In these fisheries, fishers have a large incentive to avoid shark interactions. In the Italy longline fishery, despite a lack of market for shark products, low shark interaction rates result in low incentive to reduce shark interactions. The Fiji longline fishery attitudes towards shark interactions is unexpected. In this fishery, where almost all caught sharks are finned and carcasses discarded, fishers perceive that costs from shark interactions exceed the economic benefit. In the Chile, Japan and Peru longline fisheries, where restrictions on shark finning and retention are lacking, there is no incentive to reduce shark interactions, as revenue from sharks exceeds costs.

Table 6.1. Industry attitudes towards shark bycatch and depredation prevalent in each of 12 pelagic longline fisheries.

Pelagic Longline Fishery	Longline Industry Attitude								
	Want to minimize shark interactions due to time required to repair gear and discard sharks	Want to minimize shark interactions because revenue from catching sharks is exceeded by costs from shark interactions	Little incentive to reduce shark interactions because they are infrequent and result in nominal costs	Want to maximize shark catch because revenue exceeds economic costs from shark interactions	Want to minimize shark catch to avoid injuring crew when landing sharks from projectile swivels and shark bites	Want to minimize shark mortality because are concerned with overfishing	Want to minimize shark catch to make more baited hooks available to more valuable fish species	Shark interactions are an expected and unavoidable part of longline fishing	No incentive to reduce shark interactions because revenue from sharks exceeds costs from shark interactions
Australia Tuna and Billfish Fishery	X	X			X		X	X	
Chile Artisanal Mahi Mahi and Shark Fishery				X					X
Chile Swordfish Fishery									X
Fiji Tuna Fishery	X	X							
Italy Mediterranean Industrial Swordfish Fishery			X						
Japan Distant Water, Offshore and Nearshore Tuna Fisheries			X					X	X
Peru Artisanal Mahi Mahi and Shark Fishery				X					X
South Africa Tuna and Swordfish Fishery	X	X					X	X	
U.S. Hawaii Tuna Fishery	X	X			X		X	X	
U.S. Hawaii Swordfish Fishery	X	X			X		X	X	

There were some unique and interesting longline industry attitudes towards shark bycatch and depredation that were held by a minority of respondents. One fisherman in the Hawaii-based longline tuna fishery stated his view that sharks are a renewable natural resource, which should be managed for optimal yield as are other commercial marine resources, and that managers should institute a sustainable shark management framework. Likewise, some Australian fishermen questioned why regulations restrict the retention and disposition of sharks but not other bycatch species. Some fishers in the Chile and Peru artisanal mahi mahi and shark longline fisheries explained that during the mahi mahi season, they would prefer to catch fewer sharks and more mahi mahi because the latter species is more valuable.

## **6.2. Industry Practices**

Table 6.2 identifies practices that are in use by longline fishers to address shark interactions with longline gear. A practice is checked for a fishery only when the practice is employed predominantly for the purpose of reducing shark interactions, and not if the practice is primarily employed as a normal part of fishing operations to maximize catch rates of non-shark target species. Following subsections discuss the results of Table 6.2.

Fishermen identified numerous fishing methods and gear characteristics that they employ to maximize catch rates of non-shark target species, which may contribute to reducing shark catch rates. For instance, the depth of baited hooks; timing of gear setting, soak and hauling; location of fishing grounds in relation to topographic and oceanographic features as well as sea surface temperature; type and size of bait and hook; selection of material for the leader on branch lines; non-use of lightsticks; and other fishing methods and gear designs selected by fishermen to maximize their non-shark target species catch rates may be effective shark avoidance strategies. More research is needed to improve the understanding of the shark avoidance efficacy of many of these practices.

Table 6.2. Prevalent industry practices employed to address shark interactions in 12 pelagic longline fisheries.

Practice	Pelagic Longline Fishery									
	Australia tuna and billfish fishery	Chile artisanal mahi mahi and shark fishery	Chile swordfish fishery	Fiji tuna fishery	Italy Mediterranean industrial swordfish fishery	Japan distant water, offshore and nearshore fisheries	Peru artisanal mahi mahi and shark fishery	South Africa tuna and swordfish fishery	U.S. Hawaii tuna fishery	U.S. Hawaii swordfish fishery
Move position if shark interactions are high and target species CPUE is low	X		X	X			X	X	X	X
Avoid fishing grounds with high shark abundance from past experience or communication from other vessels	X			X		X			X	X
Reduce shark detection of baited hooks										
Set gear deeper	X									
Use or avoid type of bait or hook	X									
To discard sharks, cut branch line or remove hook by making cut in shark mouth	X				X			X	X	X
No wire trace to reduce retention of sharks	X									
Do not use lightsticks	X									
Avoid setting in specific sea surface temperature	X									
Set during daytime	X									
Minimize gear soak time	X									
Kill sharks before discarding to avoid re-catching	X									
Do nothing to reduce shark catch because shark catch is desirable or shark interactions are rare		X			X		X			

### 6.2.1. Avoid peak areas and periods of shark abundance

In fisheries where there is an incentive to avoid shark interactions, avoiding areas known to have high shark abundance and moving position when shark interaction rates are high are predominant shark avoidance practices. At the simplest level, individual fishing vessels can avoid setting in an area known to have high shark capture and depredation rates, which might occur seasonally. This is a practice identified by some members of the longline fisheries in Australia, Fiji, South Africa, Japan and Hawaii. Additionally, many fishers from several of the fisheries reported that when they experience high shark capture, depredation, or gear damage and loss in a haul, if the target species catch rate is not particularly high, they might move to a new location before making another set. For instance, during mahi mahi season, most fishers in the Peru artisanal longline mahi mahi and shark fishery will change position when gear damage and loss from sharks is particularly high (Mangel and Alfaro-Shigueto, this volume). Most of the fishers interviewed in the South Africa longline tuna and swordfish fishery identified moving position when shark catch rates are high (Petersen and Goren, this volume).

Fishing position in relation to (i) certain sea surface temperatures, (ii) topographic features such as shelf breaks and sea mounts, and (iii) oceanographic features such as currents, fronts, and gyres, may affect shark interaction rates. Australian fishermen identified setting on the colder side of fronts in order to reduce shark catch levels. Catch rates of blue sharks have been found to decline by 9.7-11.4% in response to only a 0.6° C increase in sea surface temperature (Watson et al., 2005). Not surprisingly, it has also been shown that blue sharks tend to prefer sub-surface depths that possess cooler temperatures (e.g. Simpfendorfer et al., 2002). However, more comprehensive studies on blue shark distribution according to full water column temperature profiles and thermocline dynamics are necessary before amending fishing practices in accordance with patterns in sea-surface temperatures.

### 6.2.2. Reduce shark detection of baited hooks

Very few interviewed fishers believe that refraining from chumming during the set and not discarding offal and spent bait during the haul will substantially affect shark interactions. Chumming during sets is not a common practice in the pelagic longline fisheries included in this study. Offal and spent bait are typically discarded overboard during hauling operations. Many respondents explained that it would be impractical to retain spent bait and offal to discard at the end of hauling because of the lack of space on the vessels. Some fishers avoid using lightsticks because of the belief that this would increase their shark catch rate (Brothers, this volume).

### 6.2.3. Reduce shark catch rate through deeper setting, line material or type of bait or hook

Some fishers indicated that they avoid the use of certain types of bait to reduce shark interactions, or perceive that avoiding certain bait types will reduce shark capture rates (e.g., Italy and Japan, avoid squid (Clarke, this volume; Piovano, this volume); Australia, avoid oily pilchard and squid (Brothers, this volume)). Few fishers believe that hook shape has a large effect on shark catch rates. Furthermore, some fishers indicated that they set their gear at a certain depth or perceive that setting deeper would contribute to reducing shark interactions (Hawaii, Australia, Italy, Japan).

Most fishers believe that the depth of baited hooks and timing of the gear soak influence shark catch rates. The deployment depth of hooks and timing of the soak and haul (day versus night) can have an influence on fish species CPUE, including sharks, perhaps due to different water temperature preferences by each species (Strasburg, 1958; Sciarrotta and Nelson, 1977; Rey and Munoz-Chapuli, 1991; Williams, 1997). For example, Rey and Munoz-Chapuli (1991) found higher mako shark (*Isurus oxyrinchus*) CPUE on shallower set hooks, and no mako capture on the three deepest hooks in a basket, which were estimated to be set to between 370-460 m deep, in a Spanish tropical eastern Atlantic surface longline swordfish and mako shark fishery. Williams (1997) found that main pelagic shark species, with the main exception being the mako sharks, tend to be taken at a higher rate in more shallow-set gear than vessels setting gear deeper in central and western Pacific pelagic longline tuna fisheries. Blue shark, silky shark, pelagic stingray, and oceanic whitetip CPUE were 2.7, 6.4, 1.1, and 2.8 times higher, respectively, in shallow vs. deep set gear (Williams, 1997). Setting baited hooks below a threshold depth may reduce bycatch and depredation by certain species of sharks in certain areas, but shark interaction rates may also depend on when it is that the hooks are at these depths.



One fisher in the Hawaii-based longline tuna fishery tried various types of artificial baits to determine their ability to catch target species and to reduce shark capture. He found that the artificial baits did not catch tuna well and that they were not strong enough as he lost about 90% of the artificial baits after one fishing trip. One fisher in the Peru artisanal mahi mahi and shark longline fishery reported having tried an artificial bait, which did not reduce shark interactions. Artificial baits may hold promise to reduce shark capture and depredation. For instance, the Alaska demersal longline sablefish (*Anoplopoma fimbria*) and Pacific halibut (*Hippoglossus stenolepis*) fishery tested an artificial bait and found that the artificial bait caught as many or more target species and reduced bycatch of spiny dogfish shark (*Squalus acanthias*), skate (*Raja* spp.), arrowtooth flounder (*Atheresthes stomias*), and Pacific cod (*Gadus macrocephalus*) by more than ten times compared to a control of fishing with herring bait, the conventional bait used in this fishery (Erickson et al., 2000).

The type of hook and natural bait used affects shark CPUE and may also affect depredation rates (Williams, 1997; Gilman et al., 2006a). Research in the Azores longline swordfish and blue shark fishery found that when non-offset 16/0 circle hooks were used, there was a significantly higher blue shark CPUE than when fishing with a non-offset 9/0 J hook in a 2000 study when blue sharks were not being targeted due to low market demand (Bolten and Bjorndal 2002). In a 2001 study in the Azores fishery, when blue sharks were being targeted, fishing with non-offset 16/0 and non-offset 18/0 circle hooks caught significantly more blue sharks than when fishing with a non-offset 9/0 J hook (Bolten and Bjorndal 2003). Thus, in both Azores studies, fishing with a circle hook results in a significantly higher blue shark catch rate when compared to fishing with a J hook. A study conducted in the U.S. North Atlantic longline swordfish fishery found that use of a non-offset or 10 degree offset 18/0 circle hook with squid bait resulted in a small but significant increase in blue shark CPUE (8% and 9% increases, respectively) compared to fishing with a 9/0 J hook with squid (Watson et al., 2005). Watson et al. (2005) also found that fishing with a 10 degree offset 18/0 circle hook with mackerel bait and fishing with a 9/0 J hook with mackerel bait resulted in a significant and large reduction in blue shark CPUE by 31% and 40%, respectively, compared to fishing with a 9/0 J hook with squid. Research in an experimental Japanese North Pacific longline fishery found no difference in the capture rate of blue sharks between a circle and Japan tuna hook (Yokota et al., 2006a,b). Thus, results from controlled experiments in the Azores and U.S. North Atlantic longline fisheries indicate that fishing with fish instead of squid for bait causes a significant decrease in shark CPUE, while using a wider circle hook instead of a narrower J hook may cause a significant but small increase in shark CPUE.

An assessment of observer data from the Hawaii longline swordfish fishery is consistent with results from the controlled experiments (Gilman et al., 2006a). Shark combined species CPUE was significantly lower by 36% after regulations came into effect, which required the fishery to switch from using a 9/0 J hook with squid bait to using a 10° offset 18/0 circle hook with fish bait (Gilman et al., 2006a).

Avoiding certain material for branch lines could also reduce shark depredation and catch rates. For instance, the use of rope/steel ("Yankee") gangions resulted in lower juvenile sandbar shark catch rates than when using monofilament gangions (Branstetter and Musick, 1993). In another study, percent-capture of blue shark with the use of monofilament gangions (66%) exceeded that when employing multifilament gangions (34%) (Stone and Dixon, 2001). Shortfin mako shark catches adhered to the same pattern (60% and 40%) for 'mono' and 'multi' line, respectively. Stone and Dixon (2001) surmise that the relative aversion to the multifilament gangion could have been a function of strong visual acuity, a trait shared by pelagic predators that often hunt nocturnally.

#### **6.2.4. Reduce injury to discarded sharks**

Most sharks caught in pelagic longline fisheries are alive when hauled to the vessel (Chapter 3) (Williams, 1997; Brothers, this volume; Gilman, this volume; Mangel and Alfaro-Shigueto, this volume; Thomson, this volume), suggesting that improved handling and release methods to improve shark post-release survival prospects holds promise to reduce fishing mortality of discarded sharks. When a shark will be discarded, the majority of the time in the fisheries included in this study, fishers will cut branch lines to discard hooked sharks, will cut the hook out of the shark's mouth or will pull the hook out by force in order to retrieve the terminal tackle before discarding the shark. A minority of interviewed fishermen report occasionally landing and killing sharks in order to recover fishing gear before discarding a shark. Fig. 6.1

shows some of the tools used by longline fishermen to assist with immobilizing and retrieving terminal tackle from sharks. The survival of sharks that are not finned, that are deeply hooked (where the shark has swallowed the hook) and have hooks removed by fishers pulling the hook out likely depends on where they were hooked and how much damage is done by pulling out the hook. In these cases of deeply hooked sharks, as is believed to be the case for sea turtles (Gilman et al., 2006a), prospects for shark post release survival might be improved by having fishers cut the line as close to the shark as safely possible.



Fig. 6.1. Some of the tools used by longline fishermen to immobilize and retrieve terminal tackle from sharks. Hawaii longline fisherman demonstrating how he clips a loop of rope onto a branch line below the weighted swivel at the top of the wire leader to assist with removing a hook from caught sharks (left); ring and electrical cord of a “shocker” device used by a Japanese nearshore longline fishermen to immobilize sharks (middle); Chilean fisherman’s improvised dehooker (right) (photos by E. Gilman, J. Mangel, T. Miyamoto).

A large proportion of sharks caught in longline gear that is released after removal of the hook from the mouth are expected to survive. Research conducted by the U.S. National Marine Fisheries Service Pacific Islands Fisheries Science Center using pop-up satellite archival tags found that 97.5% of pelagic sharks released after capture on longline gear survived (1 of 40 captured sharks died), while a study by the U.S. National Marine Fisheries Service Southwest Fisheries Science Center found that 94% of 17 tagged shortfin mako sharks survived beyond two months after release (U.S. National Marine Fisheries Service, 2005). Some vessels in the Australia longline fishery are known to use firearms to safely and efficiently kill caught sharks to retrieve terminal tackle, while some vessels in the Australia and Hawaii fisheries will kill caught sharks in an effort to avoid the inconvenience of their recapture. However in the Hawaii fisheries, observer data show that a very small proportion of caught sharks that are alive when hauled to the vessel are killed before discarding (Gilman, this volume). This is also the case in the Peru longline mahi mahi and shark fishery (Pro Delphinus, unpublished data; Mangel and Alfaro-Shigueto, this volume). Some vessels in the Hawaii longline fleet report that, when they are busy processing commercially valuable species on deck, they will place a tarred rope with a knot at the end off the stern and will clip branch lines containing sharks onto this rope so they can remove the sharks from the gear after they have completed the haul and processed the catch. The majority of sharks placed on this line will have fallen off before the end of the haul, while most sharks remaining on the line when it is retrieved are dead. In the Italy Mediterranean industrial longline swordfish fishery, some fishermen reported that, in the past when shark capture rates were higher, they would routinely kill all caught sharks in order to reduce local shark abundance, which they believed would result in an increase in their swordfish catch by reducing shark predation on the swordfish (Piovano, this volume). Reducing such practices that result in the mortality of discarded sharks would contribute to preventing the unsustainable exploitation of sharks.

A few of the interviewed fishers report killing all caught sharks in order to prevent the inconvenience of recapturing them, reduce shark depredation, and in one case, to reduce shark populations to reduce the likelihood of being killed by a shark if he ever has to abandon ship (Brothers, this volume; Gilman, this volume; Thomson, this volume). While this attitude was not held by the majority of the fishers

interviewed, it is useful to identify as a potential obstacle to introducing new techniques to improve the post-release survival prospects of caught sharks that are discarded.

While circle hooks may result in a higher shark CPUE than J and Japan tuna style hooks (Section 6.2.3), because fish caught on circle hooks are more likely to be hooked in the mouth versus swallowing the hook, removal of circle hooked sharks is easier and may result in reduced injury to the shark than sharks caught on other hook types.

None of the interviewed pelagic longline fishermen use dehookers to discard live sharks. Only two fishers, one from the Chile artisanal mahi mahi and shark longline fishery and one from the Peru artisanal mahi mahi and shark longline fishery, report that they use a dehooker to recover hooks from sharks when these are onboard and already dead (Alfaro-Shigueto et al., this volume; Mangel and Alfaro-Shigueto, this volume). The Peruvian fisher possessed the dehooker initially for the purpose of releasing sea turtles. A benefit of using a dehooker might include reduced time to retrieve terminal tackle. The U.S.-based company Aquatic Release Conservation produces a 0.8 m long "Big Game" and a 0.4 m long "Bite Block" dehooker, which are designed to remove hooks from sharks brought onboard. For sharks that are too large to bring onboard, this company also produces a 2.4 m long and 3.7 m long dehooker on a pole. The effect of dehookers on the post-release survival prospects of sharks compared to crew cutting a hook from the shark or cutting the branch line and leaving a hook and trailing line attached to the shark has not been assessed. Almost all of interviewed fishers from all fisheries included in the study, except South Africa where all the fishers thought use of a dehooker would reduce shark injury, believe that it would be inefficient to use dehookers to remove sharks from gear, either because this would increase the safety risk, or because it is simply not feasible to use this device to remove sharks. Some caught sharks will twist and spin when hauled to the vessel, which could cause the dehooker to be lost overboard and be a hazard for crew to handle before being lost overboard. Because sharks may be on the sea surface when being hauled, some fishers were concerned that the incidence of having branch lines break if a shark pulls the line would increase with use of a dehooker because to use a dehooker requires bringing the shark close to the vessel.

Gear soak time also likely affects the proportion of caught sharks that are alive when hauled to the vessel. Changes to fishing gear and methods that reduce soak time could contribute to reducing fishing mortality of discarded sharks.

#### **6.2.5. Reduce retention of sharks on branch lines**

Retention of sharks on branch lines with wire leaders or other durable material is substantially higher than in gear with no wire leader where nylon monofilament is connected directly to the hook (Chapter 4) (e.g., Williams, 1997). For instance, an owner-operator of a vessel in the Japan nearshore pelagic longline fishery who seasonally will target sharks stated that he does not use a wire leader (nylon monofilament is used through to the hook) when he is targeting tunas and billfish because he believes that this gear design maximizes the catch of these target species. He uses a 1 m wire trace at the hook during seasons when he targets sharks (Clarke, this volume). Also, fishers in the Chile and Peru artisanal longline mahi mahi and shark fisheries will add a wire leader to increase shark catch rates (Alfaro-Shigueto et al., this volume; Mangel and Alfaro-Shigueto, this volume).

## Chapter 7

### Potential of Deterrents, Hotspot Avoidance and Incentive Instruments to Reduce Shark Interactions in Pelagic Longline Fisheries

Fleet communication programs can enable a longline fleet to avoid shark hotspots. The distribution of sharks in some fishing grounds is often unpredictable, and may be spatially contagious or aggregated. Consequently, fleet communication systems may be employed by fishing industry to report near real-time observations of hotspots to enable a fishery to coordinate operations to substantially reduce fleet-wide depredation and bycatch of sharks. In addition, fleet coordination of daily fishing positions and times, a current practice in many nations' fleets, may minimize per vessel shark depredation and catch levels relative to vessels that fish in isolation. Such techniques will only be of interest in fisheries where shark interactions pose a substantial economic disadvantage. These shark avoidance strategies promise to benefit shark populations as well as those fisheries where shark interactions are an economic disadvantage.

#### 7.1. Shark Deterrents

For fisheries with an incentive to reduce shark interactions, chemical, magnetic, electropositive rare earth metals and electrical repellents are promising shark deterrents. Some of these strategies are concepts requiring substantial investment to develop the technology for application in longline gear. Research and commercial demonstrations are needed to assess their efficacy at repelling sharks and effects on target and incidental species. Research and development is also needed to reduce the per-unit cost of these repellents to make them economically viable for use in pelagic longline fisheries.

Chemical deterrents, including a protein extract called 'pardaxin' from an excretion from the moses sole (*Pardachirus marmoratus*), sodium and lithium lauryl sulfate (components of common soap and shampoo) and sodium dodecyl sulfate, a related compound, have been found to repel some species of sharks under certain conditions. The moses sole extract was found to be heat sensitive and not stable when stored at room temperature; the only form in which pardaxin proved stable is freeze-dried, but in that form is only 30% as effective as fresh. The soap compounds attack fatty molecules of cell membranes in a shark's gill filaments, causing an influx of sodium ions from surrounding seawater. Smith (1991) found that shark reactions to sodium lauryl sulfate vary with concentration of soap used and from species to species.

Some fishers from the Peru artisanal mahi mahi and shark fishery, where sharks are an incidental or target species, report retaining shark offal (viscera and heads) until the end of a haul because they believe that discharging offal during the haul would deter sharks and reduce their shark catch rate (Mangel and Alfaro-Shigueto, this volume).

Shark Defense LLC (Oak Ridge, New Jersey, USA – based company) has identified semiochemical-based repellents that have been shown to cause six species of sharks to leave an area after the chemical was disbursed without repelling teleost fish such as pilot fish and remora accompanying the sharks (Eric Stround, personal communication, Shark Defense LLC, 3 April 2006). Presumably, this can be ascribed to an apparent aversion in sharks to certain chemicals, including ammonium acetate (a major component in decaying shark flesh) and other semiochemicals emitted from predators (Sisneros and Nelson, 2001). When mixtures of semiochemicals were introduced into feeding aggregations of sharks and teleost fish in reef habitat, sharks quickly left the feeding area while bony fish stayed in the area and continued feeding (U.S. National Marine Fisheries Service, 2005). The semiochemicals, originally derived from decayed shark carcasses, but now produced synthetically, may elicit a flee response in elasmobranchs but not in bony fish, but research results are not yet available in a peer-reviewed publication.

A preliminary study was conducted by the U.S. National Marine Fisheries Service Pacific Islands Fisheries Science Center in Hawaii in early 2005 comparing catch of target species and sharks in sets using bait injected with synthetic shark semiochemicals produced by Shark Defense LLC to sets using untreated bait. Results were inconclusive, in part, because the research design prevents conclusions to be drawn on the single factor effect of the presence or absence of semiochemicals in the bait on shark and target species CPUE, and because it was not possible to confirm that bait injected with semiochemicals retained the chemical throughout the gear soak (U.S. National Marine Fisheries Service, 2005).

Since conducting this 2005 trial in Hawaii, the chemical is now available in a hydroxypropyl cellulose and glycol ether ester gel matrix, where the viscosity of the gel prevents it from being poured (Eric Stround, personal communication, Shark Defense LLC, 3 April 2006). In current ongoing trials the gel is placed in biodegradable, porous muslin bags filled with 100 ml of the gel at 30.5 cm above a bait. The gel has been observed to dissolve evenly over an 8-hour period while the fishing gear soaks. The gel could also be syringed directly into a bait or a bag of the gel could be stuffed into a bait (Eric Stround, personal communication, Shark Defense LLC, 3 April 2006). One bag filled with 100 ml of the gel matrix would cost about USD 1.05 (Eric Stround, personal communication, Shark Defense LLC, 3 April 2006). Pre-treated baits may be a less expensive option. Shark Defense conducted preliminary trials of the chemical's effect on shark and target species CPUE in Bahamas demersal longline fishery, on captive yellowfin tuna by the Inter-American Tropical Tuna Commission, and on captive cobia (*Rachycentron canadum*) by the University of Miami. Results to date are promising (Eric Stround, personal communication, Shark Defense LLC, 3 April 2006). It is hypothesized that when the semiochemical is at a concentration  $\geq 0.1$  ppm it will repel Carcharhiniform sharks without repelling bony fish (Eric Stround, personal communication, Shark Defense LLC, 3 April 2006).

Shark Defense is also conducting preliminary trials of neodymium-iron-boride ( $\text{Nd}_2\text{Fe}_{14}\text{B}$ ) magnets as a possible shark deterrent in longline gear (Eric Stround, personal communication, Shark Defense LLC, 3 April 2006). It is hypothesized that a 10 cm x 4 cm NdFeB magnet's field would be effectively detected by sharks up to a 0.3 m range. Sharks possess an organ, Ampullae of Lorenzini, that is used to detect weak electrical fields at short ranges. Preliminary research conducted in 2005 on the effect of  $\text{Nd}_2\text{Fe}_{14}\text{B}$  magnets by the Inter-American Tropical Tuna Commission on captive yellowfin tuna and by the University of Miami on cobia indicates that the presence of the magnet versus a control produced no significant difference in feeding behavior (Eric Stround, personal communication, Shark Defense LLC, 3 April 2006). Preliminary research in a demersal longline fishery in the Bahamas is underway. A 2.5 cm x 2.5 cm  $\text{Nd}_2\text{Fe}_{14}\text{B}$  nickel-coated cylinder with a center bore costs about USD 300 for 100 magnets (Eric Stround, personal communication, Shark Defense LLC, 3 April 2006).

A recent discovery by SharkDefense shows that electropositive metals (e.g. Neodymium, Praseodymium, early Lanthanide metals, Mischmetal, and Magnesium) may repel sharks (Eric Stround, personal communication, Shark Defense LLC, 9 February 2007). These metals, which are also present in rare earth magnets, may be responsible for some of the repellency effect seen with permanent magnets and present a more practical alternative to the magnets. These metals are not inherently magnetic (they are not ferromagnetic). A correlation has been found between standard oxidation potential of these metals and their behavioral response using immobilized sharks.

An electrical shark avoidance device was tested in a coastal midwater trawl fishery in the Sea of Japan (Ishikawa Prefecture) in 2004 (Clarke, this volume). The purpose of the device was to deter predation by sharks on the cod end of the trawl during hauling. The device, mounted on the fishing vessel, emitted an electrical pulse into the waters in the immediate vicinity. It was believed by fishermen to be effective based on qualitative observations of sharks suddenly moving away from the cod end and the vessel once the electrical pulse was emitted (Clarke, this volume).

The Shark Protective Ocean Device (POP) is a device designed to be worn by scuba-divers that emits an electrical field with a radius of 4-6 m to repel sharks from divers ([www.elasmo-research.org](http://www.elasmo-research.org)). The device costs about USD 700. This technology theoretically could be modified to deter sharks from foraging on bait and catch on longline hooks.

Acoustic deterrents may reduce shark-longline interactions, but have not been tested in longline fisheries for any shark species.

## 7.2. Hotspot Avoidance through Fleet Communication and Protected Areas

Fleet communication programs and area and seasonal closures are management tools that can enable a longline fleet to avoid bycatch hotspots that can complement employment of other strategies to reduce shark bycatch and depredation. The distribution of sharks and other species groups such as seabirds, sea turtles and cetaceans, is often unpredictable, and may be spatially contagious or aggregated. Consequently, fleet communication systems may be employed by fishing industry to report near real-time observations of hotspots to enable a fishery to operate as a coordinated "One Fleet" to substantially reduce fleet-wide depredation and bycatch of sharks (Gilman et al. 2006c). In addition, fleet coordination of daily fishing positions and times, a current practice in many fleets, may minimize per vessel shark interaction levels relative to vessels that fish in isolation (Gilman et al., 2006c).

Area and seasonal closures can also contribute to reducing shark-longline interactions. Establishing protected areas within a nation's Exclusive Economic Zone is potentially an expedient method to reduce shark-longline interactions. However, establishing and managing high seas marine protected areas to protect sharks, which would require extensive and dynamic boundaries and extensive buffers, may not be a viable short-term solution. This is due in part to the extensive time anticipated to (i) resolve legal complications with international treaties, including creating legally binding mechanisms for multilateral designation and management of high seas protected areas; (ii) achieve international consensus and political will; (iii) provide requisite extensive resources for surveillance and enforcement, in part, to control illegal, unreported and unregulated fishing activities; and (iv) improve the scientific basis for designing high seas marine protected areas, which can be effective at reducing shark interactions only where the location and times of occurrence of shark hotspots are known and predictable (Gilman, 2001). However, establishing and managing a representative system of protected area networks on the high seas to contribute to the management of interactions between marine capture fisheries and highly migratory sensitive species groups, including sharks, may eventually be realized.

Recent developments within the framework of the United Nations Convention on the Law of the Sea and associated conventions and by several Regional Fishery Management Organizations may make it possible in the near future to establish marine protected areas on the high seas that restrict fishing activities that are shown to threaten rare or fragile ecosystems or the habitat of depleted, threatened or endangered species and other forms of marine life. It is already possible to establish high seas marine protected areas for discrete areas by agreement by individual countries. However, there remains a need for an international framework with specific language to identify the criteria to establish a representative system of high seas marine protected area networks, and management and enforcement measures for the individual marine protected areas. Several regional fishery management organizations are updating their scope and legal mandate to include ecosystem-based management and biodiversity conservation under the auspices of the Fish Stocks Agreement. The Commission for the Conservation of Antarctic Marine Living Resources has made some preliminary progress towards establishing a system of marine protected areas in the Southern Ocean.

Consequences of establishing a protected area need to be carefully considered, as resource use restrictions of a marine protected area may displace effort to adjacent and potentially more sensitive and valuable areas, where weaker management frameworks may be in place (Murray et al., 2000; Baum et al., 2003; Kotas et al., 2004). Also, measures adopted by regional fishery management organizations and other international bodies are only binding to parties to the Convention that established the organization, and will not control activities by non-party States. Thus, another consideration for employing high seas marine protected areas to manage problematic fisheries bycatch is that closing areas to fisheries only of party States could result in increased effort in this area by fleets from non-party States with fewer or no controls to manage bycatch, exacerbating the problem for which the MPA was established to address.

International bodies have created marine protected areas on the high seas: The International Whaling Commission declared the Indian and Southern Oceans as no-take sanctuaries for whales, covering 30 percent of the world's oceans mostly on the high seas. Conventions governing international shipping have designated large areas of the ocean that include high seas as Special Areas where stringent restrictions apply regarding discharges from ships. Furthermore, under the United Nations Convention on the Law of the Sea, the International Seabed Authority could protect areas from minerals extraction beyond national jurisdiction where there is a risk of harm to the marine environment (Kelleher, 1999). Recent developments within the framework of the United Nations Convention on the Law of the Sea and associated conventions may make it possible in the future to restrict fisheries activities on the high seas that are shown to undermine marine conservation (Kelleher, 1999).

### **7.3. Incentive Instruments**

Several incentive instruments can be instituted by industry, management authorities, and conservation groups to contribute to industry employment of methods to reduce shark bycatch and injury (Gilman et al., 2002).

#### **7.3.1. National and local constraints**

National-level legal, regulatory, and policy-derived formal constraints, combined with an effective surveillance and enforcement program, can promote fishing industry compliance with laws, rules, and policies to minimize shark bycatch. For instance, restrictions on shark finning, wire trace and per trip shark retention are examples of regulatory constraints on pelagic longline fishery interactions with sharks. Time/area closures and mandatory use of avoidance techniques (e.g., proscribing a minimum depth for the setting of baited hooks through certain gear design specifications, using fish instead of squid for bait, prohibiting use of light sticks) are other examples of potential regulatory tools to manage shark bycatch and depredation (Hall et al., 2000; Gilman et al., 2005). Fishery management authorities could create a fee and exemption structure for shark bycatch, applicable to individual vessels or to an entire fleet, similar to a "polluter pays" system. Alternatively, the fee structure could provide a positive reward-based incentive, where a higher subsidy, lower permit or license fee, earlier start to the fishing season, or lower taxes apply, and a positive image is portrayed when a vessel or fleet meets standards for shark bycatch. The threat of a fishery closure if performance standards related to shark interactions are not met provides a strong incentive for industry compliance to minimize shark interactions.

#### **7.3.2. Regional and international accords, regulations, and policies**

Multilateral treaties and accords that address shark interactions can obligate national governments to adopt enabling legislation to manage these interactions. Regional Fishery Management Organizations can adopt regulations and policies to manage interactions between fisheries and sensitive species for compliance by member nations. Multilateral bodies can adopt advisory policies to encourage fishing nations to sustainably manage shark-longline interactions. Recent international initiatives addressing shark finning are summarized in the Introduction.

#### **7.3.3. Eco-labeling**

Consumer demand can alter industry behavior. In 2005 the Committee on Fisheries of the Food and Agriculture Organization of the United Nations adopted Guidelines for the Ecolabelling of Fish and Fishery Products from Marine Capture Fisheries. The new guidelines provide guidance to governments and organizations that already maintain, or are considering establishing, labeling schemes for certifying and promoting labels for fish and fishery products from well-managed marine capture fisheries. A longline fishing industry can pursue certification or accreditation from an eco-labeling certification program, in part, to demonstrate the employment of best practices to reduce shark bycatch and discards. The incentives to industry are market-based, to increase demand for and value of their products, and social, to receive recognition from the public for complying with accepted norms (Wessells et al., 1999). Eco-labeling can serve as an effective marketing tool for a fishing industry, when properly managed. For instance, certification under an eco-labeling scheme can be used as a marketing tool to develop and market an image and product differentiation, through advertising, sales promotion, public relations, direct

marketing, and media coverage. A company can differentiate their products from other seafood as originating from a fishery that follows internationally accepted practices to ensure environmental sustainability. This is a form of cause-related marketing, a proven means to promote recognition and develop a positive company image and reputation.

#### **7.3.4. Industry and market self-policing**

A longline industry can create a program where information on individual vessel shark bycatch levels and compliance with relevant regulations is made available to the entire industry. This self-policing program uses peer pressure within the fishing industry to criticize 'bad actors' and publicly acknowledge those fishers who are operating in a responsible manner. For example, the North Pacific Longline Association initiated a seabird bycatch report card system among its members in 2000 (Fitzgerald et al. 2004). Also, there are market pressures to avoid bringing in target species damaged by sharks.



## Chapter 8

### References

- Abercrombie, D.L., Balchowsky, H.A., Paine, A.L. 2005. *2002 and 2003 Annual Summary: Large Pelagic Species*. NOAA Technical Memorandum NMFS SEFSC-529. 33p.
- Alfaro, J. Mangel, J. 2002. Pilot project to Monitor the Longline Shark Fishery in Peru. Final Report for Duke University, March 2005.
- Alverson, D.L., Freeberg, M.H., Murawski, S.A., and Pope, J.G. 1994. *A Global Assessment of Fisheries Bycatch and Discards*. Fisheries Technical Paper No. 339. Food and Agriculture Organization, Rome, Italy. 233 pp.
- Anonymous. 2005. Report of the 2004 Inter-sessional Meeting of the ICCAT Subcommittee on By-catches: Shark Stock Assessments. *Col. Vol. Sci. Papers ICCAT* 58: 799-890.
- Bailey, K., Williams, P.G., Itano, D. 1996. *By-catch and Discards in Western Pacific Tuna Fisheries: A Review of SPC Data Holdings and Literature*. Oceanic Fisheries Technical Paper No. 341. 119 pp.
- Barria, M., Donoso, P. 2006. Seguimiento del Estado de Situación de las principales pesquerías nacionales. Pesquería Recursos Altamente Migratorios, 2005. Informe Final, BIP 30033825-0, Mayo 2006.
- Bartram, P., and Kaneko, J. 2004. *Catch to Bycatch Ratios: Comparing Hawaii's Pelagic Longline Fisheries with Others*. Prepared for the Pacific Fishery Research Program and Joint Institute for Marine and Atmospheric Research, University of Hawaii, Manoa, Honolulu, Hawaii, USA.
- Baum, J.K., Myers, R.A. 2004. Shifting baselines and the decline of pelagic sharks in the Gulf of Mexico. *Ecology Letters* 7: 135-145.
- Baum, J.K., Myers, R.A., Kehler, D.G., Worm, B., Harley, S.J., and Doherty, P.A. 2003. Collapse and conservation of shark populations in the northwest Atlantic. *Science* 299, 389-392.
- Beerkircher, LR, E Cortes, M Shivji. 2002. Characteristics of shark bycatch observed on pelagic longlines off the Southeastern United States, 1992-2000. *Marine Fisheries Review* 64(4): 40-49.
- Bolten, A., Bjorndal, K., 2002. Experiment to Evaluate Gear Modification on Rates of Sea Turtle Bycatch in the Swordfish Longline Fishery in the Azores. Final Project Report submitted to the U.S. National Marine Fisheries Service. Archie Carr Center for Sea Turtle Research, University of Florida, Gainesville, Florida, USA.
- Bolten, A., Bjorndal, K., 2003. Experiment to Evaluate Gear Modification on Rates of Sea Turtle Bycatch in the Swordfish Longline Fishery in the Azores – Phase 2. Final Project Report submitted to the U.S. National Marine Fisheries Service. Archie Carr Center for Sea Turtle Research, University of Florida, Gainesville, Florida, USA.
- Bonfil, R. 2002. Trends and patterns in world and Asian elasmobranch fisheries. pp. 15-24 IN Fowler, S.L., Reed, T.M., Dipper, F.A. (eds), *Elasmobranch Biodiversity, Conservation and Management*. Occasional Paper of the IUCN Species Survival Commission, volume 25. International Union for Conservation of Nature and Natural Resources, Gland, Switzerland.
- Branstetter, S., and J.A. Musick. 1993. Comparisons of shark catch rates on longlines using rope/steel (Yankee) and monofilament gangions. *Mar. Fish. Rev.* 55: 4-9.
- Brooks, E.N., M. Ortiz, L.K. Beerkircher, P. Apostolaki, and G. Scott. 2005. Standardized catch rates for blue shark and shortfin mako shark from the U.S. pelagic logbook and U.S. pelagic observer program, and US weightout landings. *Col. Vol. Sci. Pap. ICCAT.* 58(3): 1054-1072.
- Brothers, N.P., Cooper, J., and Lokkeborg, S. 1999. The Incidental Catch of Seabirds by Longline Fisheries: Worldwide Review and Technical Guidelines for Mitigation. FAO Fisheries Circular No. 937. Food and Agriculture Organization of the United Nations, Rome.
- Buencuerpo, V., Rios, S., Moron, J. 1998. Pelagic sharks associated with the swordfish, *Xiphias gladius*, fishery in the eastern North Atlantic Ocean and Strait of Gibraltar. *Fish. Bull.* 96: 667-685.
- Burgess, G., Beerkircher, L., Cailliet, G., Carlson, J., Cortes, E., Goldman, K., Grubbs, R., Musick, J., Musyl, M., Simpfendorfer, C. 2005a. Is the collapse of shark populations in the Northwest Atlantic Ocean and Gulf of Mexico real? *Fisheries* 30(10): 19-26.
- Burgess, G., Beerkircher, L., Cailliet, G., Carlson, J., Cortes, E., Goldman, K., Grubbs, R., Musick, J., Musyl, M., Simpfendorfer, C. 2005b. Reply to "Robust estimates of decline for pelagic shark populations in the Northwest Atlantic and Gulf of Mexico. *Fisheries* 30(10): 30-31.
- Cailliet, M., Musick, J., Simpfendorfer, C., Stevens, J. 2005. Ecology and life history characteristics of Chondrichthyan fish. Pp. 12-18 IN Fowler, S., Cavanagh, R., Camhi, M., Burgess, G., Cailliet, G., Fordham, S., Simpfendorfer, C., Musick, J. (Eds.). *Sharks, Rays and Chimaeras: The Status of the Chondrichthyan Fishes*. IUCN, the World Conservation Union, Gland, Switzerland. X + 461 pp.
- Campana, S.E., L. Marks, W. Joyce, and N. Kohler. 2006. Effects of recreational and commercial fishing on blue sharks (*Prionace glauca*) in Atlantic Canada, with inferences on the North Atlantic population. *Can. J. Fish. Aquat. Sci.* 63: 670-682.

- Campana, S.E., L. Marks, W. Joyce, and N. Kohler. 2005. Catch, By-catch and indices of population status of blue shark (*Prionace glauca*) in the Canadian Atlantic. Col. Vol. Sci. Pap. ICCAT. 58(3): 891-934.
- Casey, J.G., F.J. Mather, J.M. Mason, J. Hoening. 1978. Offshore fisheries of the Middle Atlantic Bight. *Mar. Rec. Fish.* 3: 107-129.
- Catarci, C. 2004. World Markets and Industry of Selected Commercially-Exploited Aquatic Species with an International Conservation Profile. FAO Fisheries Circular. No. 990. Food and Agriculture Organization of the United Nations, Rome. 186pp.
- Chen, C., Liu, K., Joung, S., Phipps, M. 2002. Taiwan's shark fishery. An overview. Pp. 95-103 IN Fowler, S., Reed, T., Dipper, F. (Eds.). *Elasmobranch Biodiversity, Conservation and Management*. IUCN, Species Survival Commission, Gland, Switzerland.
- CITES. 2003. *Progress Made by the IUCN Species Survival Commission's Shark Specialist Group in Assessing the Threatened Status of Sharks and Related Taxa*. Nineteenth meeting of the Animals Committee, Geneva, Switzerland, 18-21 August 2003. Convention on International Trade in Endangered Species of Wild Fauna and Flora, Geneva, Switzerland, 3 pp.
- Clarke, S.C., McAllister, M., Milner-Gulland, E., Kirkwood, G., Michielsens, C., Agnew, D., Pikitch, E., Nakano, H., Shivji, M. 2006. Global estimates of shark catches using trade records from commercial markets. *Ecology Letters* 9: 1115-1126.
- Clarke, S.C., Burgess, G., Cavanagh, R., Crow, G., Fordham, S., McDavitt, M., Rose, D., Smith, M., Simpfendorfer, C. 2005. Socio-Economic Significance of Chondrichthyan Fishes. Pp. 19-47 IN Fowler, S., Cavanagh, R., Camhi, M., Burgess, G., Cailliet, G., Fordham, S., Simpfendorfer, C., Musick, J. (Eds.). *Sharks, Rays and Chimaeras: The Status of the Chondrichthyan Fishes*. IUCN, the World Conservation Union, Gland, Switzerland. X + 461 pp.
- Cook, R. 2001. *The Magnitude and Impact of By-Catch Mortality by Fishing Gear*. Reykjavik Conference on Responsible Fisheries in the Marine Ecosystem 3. Reykjavik, Iceland, 1-4 October 2001.
- Cooke, J.G., and J.R. Beddington. 1984. The relationship between catch rates and abundance in fisheries. *IMA J. Math. Appl. Med. Biol.* 1: 391-405.
- Commonwealth of Australia. 1991. Fisheries Management Act 1991. Act No. 162 of 1991 as amended.
- Cortes, E. 2002. Incorporating uncertainty into demographic modeling: application to shark populations and their conservation. *Conservation Biology* 16: 1048-1062.
- Council of the European Union. 2003. Council Regulation (EC) No. 1185/2003 of 26 June 2003. on the Removal of Fins of Sharks On Board Vessels. Official Journal of the European Union L 167: 1-3.
- Diario Oficial El Peruano. 2001. Aprueban relacion de tallas minimas de captura y tolerancia maxima de ejemplares juveniles de principales peces marinos e invertibrados. Resolucion Ministerial No. 209-2001-PE. Año XIX, Nro.7675 (27 Junio 2001), p. 205170-205171.
- Dobrzynski, T., Gray, C., and Hirshfield, M. 2002. Oceans at Risk: Wasted Catch and the Destruction of Ocean Life. Oceana, Washington, D.C., USA. 28 pp.
- Erickson, D.L., Goldhor, S., Giurca, R. 2000. Efficiency and species selectivity of fabricated baits used in Alaska demersal longline fisheries. ICES, Copenhagen. 22 pp.
- European Parliament. 2006. Removal of Sharks' Fins On Board Vessels, Resolution on the Application of Council Regulation 1185/2003 on the Removal of Fins of Sharks On Board Vessels. P6\_TA(2006)0391.
- FAO. 1999a. International Plan of Action for Reducing Incidental Catch of Seabirds in Longline Fisheries. United Nations Food and Agriculture Organization: Rome, Italy. 10 pp.
- FAO. 1999b. International Plan of Action for the Conservation and Management of Sharks. United Nations Food and Agriculture Organization: Rome, Italy. 10 pp.
- FAO. 1999c. The State of World Fisheries and Aquaculture. Food and Agriculture Organization of the United Nations, Rome, Italy.
- FAO. 2002. FISHSTAT Plus (V. 2.30), Capture Production Database 1970-2000, and Commodities Trade and Production Database 1976-2000.
- FAO. 2004a. Technical Consultation on Sea Turtles Conservation and Fisheries, Bangkok, Thailand, 29 November – 2 December 2004. Sea Turtle Conservation Concerns and Fisheries Management Challenges and Options. Food and Agriculture Organization of the United Nations, Rome. 23 pp.
- FAO. 2004b. Expert Consultation on Interactions Between Sea Turtles and Fisheries Within an Ecosystem Context. FAO Fisheries Report No. 738. Food and Agriculture Organization of the United Nations, Rome.
- FAO. 2006. Fisheries Commodities Production and Trade 1976-2004. FISHSTAT Plus - Universal software for fishery statistical time series. Fishery Information, Data and Statistics Unit, Food and Agriculture Organization of the United Nations, Rome.
- Fitzgerald, S.M., Smith, T., and Smoker, J. 2004. Implementation before regulation: Coordinated efforts to proactively reduce freezer longline seabird bycatch in Alaskan waters. P. 45 IN *Proceedings of the Thirty-first Annual Meeting of the Pacific Seabird Group*. La Paz, Mexico, 21-25 January 2004. 79 pp.
- Fowler, S., Cavanagh, R., Camhi, M., Burgess, G., Cailliet, G., Fordham, S., Simpfendorfer, C., Musick, J. (Eds.). 2005. *Sharks, Rays and Chimaeras: The Status of the Chondrichthyan Fishes*. IUCN, the World Conservation Union, Gland, Switzerland. X + 461 pp.

- Francis, M.P., Griggs, L.H., Baird, S.J. 2001. Pelagic shark bycatch in the New Zealand tuna longline fishery. *Mar. Freshwater Res.* 52: 165-178.
- Gilman E., Brothers N., Kobayashi D. 2007. Comparison of the efficacy of three seabird bycatch avoidance methods in Hawaii pelagic longline fisheries. *Fisheries Science* 73(1): 208-212.
- Gilman, E., D. Kobayashi, T. Swenarton, P. Dalzell, I. Kinan, N. Brothers. 2006a. *Efficacy and Commercial Viability of Regulations Designed to Reduce Sea Turtle Interactions in the Hawaii-Based Longline Swordfish Fishery*. Western Pacific Regional Fishery Management Council, Honolulu, HI, USA. ISBN 1-934061-02-6.
- Gilman, E., E. Zollett, S. Beverly, H. Nakano, D. Shiode, K. Davis, P. Dalzell, I. Kinan. 2006b. Reducing sea turtle bycatch in pelagic longline gear. *Fish and Fisheries* 7(1): 2-23.
- Gilman, E., Dalzell, P., Martin, S. 2006c. Fleet communication to abate fisheries bycatch. *Marine Policy* 30(4): 360-366.
- Gilman, E., N. Brothers, G. McPherson, P. Dalzell. 2006d. Review of cetacean interactions with longline gear. *Journal of Cetacean Research and Management* 8(2): 215-223.
- Gilman, E., Brothers, N., and Kobayashi, D. 2005. Principles and approaches to abate seabird bycatch in longline fisheries. *Fish and Fisheries* 6(1): 35-49.
- Gilman, E., and Freifeld, H. 2003. Seabird mortality in north Pacific longline fisheries. *Endangered Species Update* 20, 35-46.
- Gilman, E., C. Boggs, and N. Brothers. 2003. Performance assessment of an underwater setting chute to mitigate seabird bycatch in the Hawaii pelagic longline tuna fishery. *Ocean and Coastal Management* 46(11-12): 985-1010.
- Gilman, E., P. Gandini, C. Carboneras, G. Balogh, D. Leadbitter, and T. Neves. 2002. *Incentive Instruments for Sustainable Bycatch of Sensitive Species in Longline Fisheries*. IN Proceedings of the Incentives Session, Second International Fishers' Forum, 19-22 November 2002. U.S. Western Pacific Regional Fishery Management Council: Honolulu, Hawaii, USA. 11 pp.
- Gilman, E. 2001. Integrated management approach to address incidental mortality of seabirds in longline fisheries. *Aquatic Conservation* 11, 391-414.
- Hall, M.A., Alverson, D.L., and Metzals, K.I. 2000. By-catch: problems and solutions. *Marine Pollution Bulletin* 41(1-6), 204-219.
- Haward, M., Bergin, A., and Hall, H.R. 1998. International legal and political bases to the management of the incidental catch of seabirds. pp. 255-66 In *Albatross Biology and Conservation*, Robertson G and Gales R (eds). Surrey Beatty and Sons: Chipping Norton, Australia. 300 pp.
- Heberer, C.F., McCoy, M.A. 1997. *Overview of Pacific Fishing Agencies and Institutions Collecting Shark Catch Data*. Western Pacific Regional Fishery Management Council, Honolulu, 128 pp.
- Hobday, A., Stobutzki, I., and Webb, H. (2004) Draft ecological Risk Assessment of Effects of fishing: Eastern Tuna and Billfish Fishery (V7). In Hobday, A., Smith, A.D.M., and Stobutzki, I. *Ecological Risk Assessment for Australian Commonwealth Fisheries. Final Report-Stage 1. Hazard identification and preliminary risk assessment*. Report to the Australian Fisheries Management Authority, Canberra, Australia.
- Ito, R., Machado, W. 1999. *Annual Report of the Hawaii-based Longline Fishery for 1998*. U.S. National Marine Fisheries Service Southwest Fisheries Science Center, Honolulu Administrative Report H-99-06, Honolulu, HI, USA.
- IUCN. 1996a. Fisheries By-catch, Resolution 1.16. Adopted at the First World Conservation Congress, Montreal, Canada, October 13-23, 1996. World Conservation Congress, International Union for the Conservation of Nature (IUCN): Gland, Switzerland.
- IUCN. 1996b. Incidental Mortality of Seabirds in Longline Fisheries, Resolution 1.15. Adopted at the First World Conservation Congress, Montreal, Canada, October 13-23, 1996. World Conservation Congress, International Union for the Conservation of Nature (IUCN): Gland, Switzerland.
- IUCN. 2000a. Pirate Fishing and Seabird Mortality from Longlining in the Southern Ocean and Adjacent Waters, Resolution CGR2.66. Adopted at the Second World Conservation Congress, Amman, Jordan, 4-11 October 2000. World Conservation Congress, International Union for the Conservation of Nature (IUCN): Gland, Switzerland.
- IUCN. 2000b. Incidental Capture of Marine Turtles by Pelagic Longline Fisheries, Resolution 2.65. Adopted at the Second World Conservation Congress, Amman, Jordan, 4-11 October 2000. World Conservation Congress, International Union for the Conservation of Nature (IUCN): Gland, Switzerland.
- Kelleher, G. 1999. *Guidelines for Marine Protected Areas*. IUCN World Commission on Protected Areas: Gland, Switzerland. 107 pp.
- Kleiber, P., Takeuchi Y., Nakano, H. 2001. Calculation of plausible maximum sustainable yield (MSY) for blue sharks (*Prionace glauca*) in the North Pacific. Southwest Fisheries Science Center, Administrative Report H-01-02.
- Kotas, J.E., Santos, S., de Azevedo, V., Gallo, B., and Barata, P. 2004. Incidental capture of loggerhead (*Caretta caretta*) and leatherback (*Dermochelys coriacea*) sea turtles by the pelagic longline fishery off southern Brazil. *Fishery Bulletin* 102: 393-399.

- Lawson, T. 2001. Predation of Tuna by Whales and Sharks in the Western and Central Pacific Ocean. 14th Meeting of the Standing Committee on Tuna and Billfish, Working Paper SWG-6. Secretariat of the Pacific Community, Noumea, New Caledonia.
- Martin, S., Gilman, E., Dalzell, P. 2006. Meeting Hawaii longline industry needs to reduce fisheries bycatch through cooperative research. Pp. 197-203 IN Read, A.N., Hartley, T.W. (Eds.). *Partnerships for a Common Purpose: Cooperative Fisheries Research and Management*. Proceedings of the American Fisheries Society/Sea Grant Symposium 52. American Fisheries Society 135<sup>th</sup> Annual Meeting, 11-15 September 2005, Anchorage, Alaska. American Fisheries Society, Bethesda, Maryland, USA.
- Matsunaga, H., Nakano, H. 1999. Species composition and CPUE of pelagic sharks caught by Japanese longline research and training vessels in the Pacific Ocean. *Fisheries Science* 65: 16-22.
- Matsushita, Y., Matsunaga, H. 2001. Species Composition and CPUE of Pelagic Sharks Observed by Japanese Observers for Tuna Longline Fisheries in the Atlantic Ocean. International Commission for the Conservation of Atlantic Tunas. ICCAT Collective Volume of Scientific Papers, 54: 1371-1380.
- McCaughran, D. A. 1992. Standardized nomenclature and methods of defining bycatch levels and implications. Proceedings of the National Industry Bycatch Workshop, Newport, Oregon, February 4-6, 1992. Seattle, WA: Natural Resources Consultants.
- McCoy, M., H. Ishihara. 1999. *The Socioeconomic Importance of Sharks in the U.S. Flag Areas of the Western and Central Pacific*. Gillett, Preston and Associates, Inc., Honolulu, Hawaii, USA, and U.S. National Marine Fisheries Service Southwest Region Administrative Report AR-SWR-00-01, La Jolla, CA, USA. 117 pp.
- Megalofonou P., Yannopoulos C., Damalas D., De Metrio G., Deflorio M., de la Serna J.M., Macias D., 2005. Incidental catch and estimated discards of pelagic sharks from the swordfish and tuna fisheries in the Mediterranean Sea. *Fish. Bull.*, 103 (4): 620-634.
- Murray, K.T., Read, A.J., and Solow, A.R. 2000. The use of time/area closures to reduce bycatches of harbour porpoises: lessons from the Gulf of Maine sink gillnet fishery. *Journal of Cetacean Research and Management* 2: 135-141.
- Musick, J.A. 2005. Introduction. Pp. 1-3 IN Fowler, S., Cavanagh, R., Camhi, M., Burgess, G., Cailliet, G., Fordham, S., Simpfendorfer, C., Musick, J. (Eds.). *Sharks, Rays and Chimaeras: The Status of the Chondrichthyan Fishes*. IUCN, the World Conservation Union, Gland, Switzerland. X + 461 pp.
- Musick, J.A., Burgess, G.H., Camhi, M., Cailliet, G., Fordham, S. 2000. Management of sharks and their relatives (*Elasmobranchii*). *Fisheries* 25(3): 9-13.
- Nakano, H. and S. Clarke. 2006. Filtering method for obtaining stock indices by shark species from species-combined logbook data in tuna longline fisheries. *Fisheries Science* 72: 322-332.
- Neves dos Santos, M., Garcia, A., Pereira, J.G. 2001. A Historical Review of the By-Catch from the Portuguese Surface Long-Line Swordfish Fishery: Observations on Blue Shark (*Prionace glauca*) and Short-Fin Mako (*Isurus oxyrinchus*). International Commission for the Conservation of Atlantic Tunas. ICCAT Collective Volume of Scientific Papers, 54: 1333-1340.
- PROMPEX, Comision para la Promocion de Exportaciones. On-line information. May 2006. [www.prompex.gob.pe](http://www.prompex.gob.pe).
- Rago, P.J., KA Sosebee, JKT Brodziak, SA Murawski, ED Anderson. 1998. Implications of recent increases in catches on the dynamics of northeast Atlantic spiny dogfish (*Squalus acanthias*). *Fish. Res.* 39(2): 165-181.
- Rey, J.C., Munoz-Chapuli, R. 1991. Relation between hook depth and fish efficiency in surface longline gear. *Fishery Bulletin* 89(4): 729-732.
- Reyes, J.C., 1993. *Reintroduction of Longlines in the Peruvian Shark Fishery: An Alternative to Reduce Small Cetacean Mortality*. Final report for the Cetacean Specialist Group, Species Survival Commission of the International Union for the Conservation of Nature and Natural Resources IUCN, and the Whale and Dolphin Conservation Society WCS. 30 pp.
- Ripley, WE. 1946. The soupfin shark and the fishery. *California Department of Fish and Game Fisheries Bulletin* 64: 7-37.
- Rose, C., and McLaughlin, K. (2001) Review of shark finning in Australian fisheries, Bureau of Rural Sciences, Canberra, Australia
- Sarmiento, C. 2004. *Assessing market transfer effects generated by court rulings in the Hawai'i longline fishery*. Western Pacific Regional Fishery Management Council, Honolulu, Hawaii, USA.
- Sciarrotta, T.C., Nelson, D.N. 1977. Diel behavior of the blue shark, *Prionace glauca*, near Santa Catalina Island, California. *Fisheries Bulletin*, 75: 519-528.
- Shotton, R. 1999. Species Identification Practices of Countries Reported Landings of Chondrichthyan Fishes in the FAO Nominal Catches and Landings Database. Pp. 904-920 IN Shotton, R. (Ed.). *Case Studies of the Management of Elasmobranch Fisheries* FAO Fisheries Technical Paper No. 378, Part 2. Food and Agriculture Organization of the United Nations, Rome.
- Simpfendorfer, C.A., R.E. Hueter, U. Bergman, and S.M.H. Connert. 2002. Results of a fishery-independent survey for pelagic sharks in the western North Atlantic, 1977-1994. *Fish. Res.* 55: 175-192.
- Sisneros, J.A., and D.R. Nelson. 2001. Surfactants as chemical repellants: past, present, and future. *Env. Biol. Fish.* 60: 117-129.

- Smith, S.E., Au, D., Snow, C. 1998. Intrinsic rebound potentials of 26 species of Pacific sharks. *Mar. Freshw. Res.* 49: 663-678.
- Smith Jr., L.J. 1991. The effectiveness of sodium lauryl sulphate as a shark repellent in a laboratory test situation. *Journal of Fish Biology* 38 (1): 105-113.
- Stevens, J.D., Walker, T., Cook, S., Fordham, S. 2005. Threats faced by Chondrichthyan Fish. Pp. 48-57 IN Fowler, S., Cavanagh, R., Camhi, M., Burgess, G., Cailliet, G., Fordham, S., Simpfendorfer, C., Musick, J. (Eds.). *Sharks, Rays and Chimaeras: The Status of the Chondrichthyan Fishes*. IUCN, the World Conservation Union, Gland, Switzerland. X + 461 pp.
- Stevens, J. 2002. A Review of Australian Elasmobranch Fisheries. Pp. 122-126 IN Fowler, S., Reed, T., Dipper, F. (Eds.). *Elasmobranch Biodiversity, Conservation and Management*. IUCN, Species Survival Commission, Gland, Switzerland.
- Stone, H.H., Dixon, L.K. 2001. A comparison of catches of swordfish, *Xiphias gladius*, and other pelagic species from Canadian longline gear configured with alternating monofilament and multifilament nylon gangions. *Fish. Bull.* 99: 210-216.
- Strasburg, D., W. 1958. Distribution, abundance, and habits of pelagic sharks in the Central Pacific Ocean. *U.S. Fishery Bulletin* 138: 335-361.
- Swamy, K. 1999. Shark Fisheries in Fiji: Their Management and Issues for Future Concern. IN FAO. Case Studies of the Management of Elasmobranch Fisheries. FAO Fisheries Technical Paper, No. 378, part 1, Food and Agriculture Organization of the United Nations, Rome.
- U.S. Congress. 2000. Shark Finning Prohibition Act. 16 USC 1822, Public Law 106-557.
- U.S. National Marine Fisheries Service. 2001. Endangered Species Act Section 7 Consultation Biological Opinion: Authorization of Pelagic Fisheries under the Fishery Management Plan for the Pelagic Fisheries of the Western Pacific Region.
- U.S. National Marine Fisheries Service. 2002. Fisheries off West Coast States and in the Western Pacific; Atlantic Highly Migratory Species; Fisheries of the Northeastern United States; Implementation of the Shark Finning Prohibition Act. *Federal Register* 67(28): 6194-6202.
- U.S. National Marine Fisheries Service. 2005. *2005 Report to Congress Pursuant to the Shark Finning Prohibition Act of 2000 (Public Law 106-557)*. U.S. National Oceanic and Atmospheric Administration, U.S. Department of Commerce, Washington, D.C. 52 pp.
- U.S. National Marine Fisheries Service. 2001. *United States National Plan of Action for the Conservation and Management of Sharks*. National Marine Fisheries Service, Silver Spring, MD, USA, 89 pp.
- Ward, P., Meyers, R.A. 2005. Shifts in open-ocean fish communities coinciding with the commencement of commercial fishing. *Ecology* 86: 835-847.
- Watson, J., Foster, D., Epperly, S., Shah, A. 2005. Fishing methods to reduce sea turtle mortality associated with pelagic longlines. *Canadian Journal of Fisheries and Aquatic Sciences* 62.
- Wessells, C., Johnston, R., and Donath, H. 1999. Assessing consumer preferences for ecolabeled seafood: the influence of species, certifier, and household attributes. *American Journal of Agricultural Economics* 81(5): 1084-1089.
- Williams, P.G. 1997. *Shark and Related Species Catch in Tuna Fisheries of the Tropical Western and Central Pacific Ocean*. Prepared for the Food and Agricultural Organisation of the United Nations for the 23-27 April 1998 meeting of the Technical Working Group on Sharks. Noumea, New Caledonia: South Pacific Commission, 22 pp.
- Yokota, K., H. Minami and M. Kiyota. 2006a. Measurement-points examination of circle hooks for pelagic longline fishery to evaluate effects of hook design. *Bulletin of the Fisheries Research Agency* 17: 83-102.
- Yokota, K., M. Kiyota and H. Minami. 2006b. Shark catch in a pelagic longline fishery: Comparison of circle and tuna hooks. *Fisheries Research* 81: 337-341.

## Appendix 1

### Australia Longline Tuna and Billfish Fishery: Industry Practices and Attitudes towards Shark Depredation and Unwanted Bycatch

**Nigel Brothers, Consultant, Marine Ecology and Technology,  
brothersbone@yahoo.com.au**

#### A1.1. Fisheries Management Jurisdiction

Of Australia's eight states and territories, only one (Australian Capital Territory) has no responsibility for shark management. The others, Northern Territory, Queensland, Western Australia, New South Wales, South Australia, Victoria and Tasmania all have jurisdiction extending 3 nautical miles seaward. Beyond this, management is either a sole Commonwealth responsibility or one shared jointly with a state or territory. This extends to the edge of the 200-mile Exclusive Economic Zone (EEZ) although commonwealth fisheries management requirements can apply to Australian flagged vessels that may fish beyond this zone.

#### A1.2. Shark Fisheries in Australian Waters

Of the 10,000 t annual world shark catch, Australia is responsible for 1.26%, ranking it 19<sup>th</sup> of the 23 major shark-fishing countries (Rose and McLaughlin 2001). Excluding fisheries in which sharks are considered bycatch and or byproduct, Kailola et al (1993) list seven species of sharks, whiskery furgaleus macki, school Galeorhinus galeus, gummy mustelus antarcticus, dusky whaler carcharhinus obscurus, bronze whaler cartharhinus brachyurus, black tip, cartharhinus tilstoni, spot-tail carcharhinus sorrah, that are subjected to targeted fishing by use of gillnet, longline (demersal, as distinct from pelagic) handline or dropline. In addition to these at least 25 species are commercially exploited with saw pristiophorus curratus and p.nudipinnis, elephant callorhynchus millii, sandbar c.plumbeus and wobbegong (orectolobidae) sharks included amongst these. They can be taken in the shark target fisheries using any of the above fishing methods, or incidentally in trawl or seine fisheries. In addition to the seven shark species considered to be the target of seven recognized commercial shark fisheries, other species are taken by targeted recreational and game fishers and in two shark control programs aimed at improving human safety. At least 70 other commercial fisheries catch sharks incidentally. Between 1974 and 1986 Australia's northern waters were gillnetted by Taiwanese vessels, primarily targeting spot-tail shark (carcharhinus sorrah) and several fish species (Stevens 1999). Australian vessels started exploiting these stocks in about 1980 using both gillnet and longlines.

Of Australia's quantified shark catch, two-thirds by weight (66%) is comprised of only 15 species with the gummy shark at 27.7% constituting the greatest proportion of the total catch (Rose and SAG 2001). Whilst the next highest proportion at only 8.9% is of school sharks, 30% of sharks caught are not actually identified, and those caught in pelagic longline fishing are not represented at all in the above percentages because in this fishery the only documentation, if any, is by numbers, not weight.

Meat is the most important product from sharks with its value ranging from around \$AU7.30 per kg for school and gummy sharks to as little as \$AU1.00 kg for species such as hammerhead with \$3/kg being usual for a number of commonly marketed species. Around 8,000 ton of sharks are sold annually from Australia's fisheries with no more than around 17 tons being exported to 6 countries (Japan, Greece, Korea, Hong Kong, Malaysia and Singapore) and up to 233 tons being imported annually from five countries, (South Africa, New Zealand, Spain, New Caledonia, and Philippines).

Of the estimated 94 tons shark fin market worth approximately \$AU5.5 million it was estimated that 35% was derived from the practice of finning in the pelagic longline fishery where only the fins were being retained (prior to 1999). Rose and McLaughlin (2001) suggest that these fins were derived from 3,900 t of sharks, equivalent to one third of all other shark production (1998/99).

In addition to meat and fins, other shark products include cartilage derived from backbones and skulls as well as from fins, amounting to 27 tons worth up to \$AU5 per kg (Rose and Mc Laughlin 2001). Shark liver oil, and shark skins are also utilized but the extent of this is poorly understood but considered minimal with most shark livers from which oil for squalene can be extracted being discarded. Targeted shark fisheries in Australia are worth an estimated \$UA42 million annually.

Observer coverage in Australian fisheries in which sharks are caught has been limited to a small percent of the total fishing effort and cannot be relied upon to provide accurate estimates of the incidental shark catch. Furthermore, in the data are species identification problems (Rose and McLaughlin 2001). Likewise these problems and that of under-reporting catch exist in the obligatory logbook records of fishers. Furthermore, stock assessments have only been undertaken for six species of sharks that are subjected to target fishing.

Compared to the challenges of managing shark bycatch in non-target fisheries (Barker and Schluessel 2004), managing targeted shark resources is fairly easy. There is evidence in Australia from fisheries in which sharks are both target and non- target catch, of biomass reduction to very low levels being caused. (Graham et al 2001). For exploited demersal sharks, this pattern is consistent with worldwide trends (Shotton 1999) and is considered to reflect their susceptibility to fishing pressure as a consequence of their life history and biological attributes. Aside from seemingly typical stock status uncertainties, especially in pelagic longline fisheries, there has been substantial overfishing to as low as 18% of virgin (un-fished) biomass for some species.

### **A1.3. Introduction to the Australian Pelagic Longline Fishery**

#### **A1.3.1. Target species**

The main species targeted by pelagic longlining in Australia are bigeye, yellowfin, and albacore tuna and broadbill swordfish. Their combined catch rate is around 15 fish per 1000 hooks. Frequent retained bycatch (incidental catch) consists mostly of striped marlin, dolphinfish, spearfish, rudderfish, Rays bream, oilfish as well as pelagic sharks (Hobday et al., 2004; Dambacher, 2005). Excluding sharks, the combined catch rate of these incidental catch species is around 5.5 fish per 1000 hooks. This species composition of catch is very similar to that of many other of the world's pelagic longline fisheries with a high likelihood therefore of similarities in fishing equipment and how it is used. This is an important aspect for understanding bycatch issues and potential mitigation options across fisheries.

According to recent fishery statistics (ABARE, 2005) the gross value of production in the pelagic longline fishery was around \$AU55 million, 3.8 million being from species that may have included sharks in 2003/04.

Sharks inhabit Australian waters from the far northern tropical waters to cool temperate southern waters, all of which are subjected to pelagic longline fishing. It is this situation alone that has produced such a diverse range of attitudes to handling or utilization of sharks caught, in responding to the changes in shark species and their abundance encountered.

#### **A1.3.2. Management regime**

For the majority of present fishing effort management is by Total Allowable Effort (TAE), an input control, although because the preferred management method in Australia's fisheries is by Individual Transferable Quota (ITQ) this could be applied in the future.

**A1.3.3. Size of fleet**

Currently (2006) there are between 80 and 90 vessels in the fishery, all but one of which are operating on Australia's east coast with the majority of these based at the port of Mooloolabah. Vessels operate from 12 or more ports scattered along about 3500 km of the east coast. This fleet has rapidly declined from a peak of around 120 vessels in only the past year or so. Further reduction in fishing effort is expected.

**A1.3.4. Vessel type**

Most vessels are between 15 - 30 m in length and are either general-purpose inshore vessels or purpose-built ones capable of high seas fishing.

**A1.3.5. Crew**

Maximum number recorded from a sample of 35 vessels was 6, the minimum 2, with an average of 4 per vessel.

**A1.3.6. Fishing gear**

Boats use monofilament mainlines set through stern-mounted line shooters from typical commercially produced mainline reels (spools) with two-section monofilament branchlines set manually off the vessel's stern and retrieved again into the hook boxes via hydraulic branchline (snood) pullers. All vessels are equipped with the latest in electronics equipment.

**A1.3.7. Bait type**

Squid and pelagic fish species are used for bait, including pilchards, jack mackerel, yellowtail scad, blue mackerel (and other mackerel), anchovy, redbait, tooth-whiptails and redfish. Approximately 11% of bait is caught by vessels and held aboard alive in circulating tanks for extended periods.

**A1.3.8. Target catch**

Although approximately 100 species (including fishes) have been recorded as taken in the fishery, the main catch is yellowfin, bigeye, and albacore tuna, broadbill swordfish and striped marlin. These constitute approximately 60% of all fish caught with main incidental species constituting an additional 23%.

**A1.3.9. Shark catch**

With an average catch rate of between 1.3 and 5.5 sharks per thousand hooks, approximately 12,000 - 50,000 sharks may be caught annually. The current practice is for the majority of sharks to be discarded alive.

**A1.3.10. Catch storage**

The fishery is a fresh fish fishery (as opposed to frozen at sea). The catch is kept on ice, in ice slurry, brine, or brine spray systems.

**A1.3.11. Trip length**

Trip length is generally around 4 days, but frequently shorter. The longest trip (based on information from 178 trips during which at least one set occurred) was 30 days.

**A1.3.12. Daily fishing pattern**

The typical fishing pattern is a set of 950 hooks commenced in the late afternoon at around 3 pm. Setting takes about 3.5 hours, after which the vessel drifts until line hauling commences in the early morning around 5 am. Hauling takes about 8 hours.

**A1.3.13. Market**

The majority of the catch is exported to the Japanese market.



#### A1.4. Shark Species Encountered by Pelagic Longline Vessels in Australian Waters

Of the 166 species of sharks that occur in Australian waters, almost half of which are endemic to Australia (Last and Stevens 1994), fewer than 12 are commonly caught by pelagic longliners (Stevens and Wayte 1998). Blue sharks are caught in greatest numbers, with oceanic white tips, porbeagle, short fin mako, thresher spp., silky and crocodile sharks also being frequently caught. Less frequently caught are hammerhead, tiger, dogfish (family squalidae) and longfin mako sharks. There is uncertainty in the species composition of shark catch due to observer identification inaccuracies that can arise due to similarities in appearance between species.

In addition to the 'true' sharks, a further 130 chondrichthyans, 117 rays and 13 chimaeras occur here. At least several species of pelagic rays are caught regularly on pelagic longlines. For instance, approximately 1500 rays are estimated by Dambacher (2005) to be caught annually. In total, about 80 fish species have been recorded in catches of Australian pelagic longlining (Hobday et al 2004).

#### A1.5. Shark Catch Rates in Australian Pelagic Longline Fisheries

Extrapolation of observed blue shark catch rates from total fishery effort by foreign longline vessels fishing in Australian waters up until their exclusion in 1997 indicates that around 86,000 or 1,100 tons (approx 0.1% of the estimated world catch of this species (Bonfil 1994)) were being caught annually. This species comprised 84.7% of the total shark catch. Catch rates and total catches by species are largely a consequence of changes with latitude in species abundance (Stevens 1992) and over 80% of the fishing effort in this instance was South of 30° South latitude. Catch rates of the same species in New Zealand and Australia from similar latitudes were not the same. For example, blue shark CPUE in New Zealand was typically < 15 blue sharks per 1000 hooks, but could occasionally be as high as 114 (Francis et al 2000) while in Australia, the average blue shark catch rate was 5.5 per 1000 hooks, occasionally exceeding 100 (Steven 1992, Stevens and Wayte 1999).

For other less frequently caught species, catch rates were less than 0.5 individuals per 1000 hooks (Stevens and Wayte 1998). For shortfin makos, the observed catch rate was 0.2 per 1000 hooks or some 3,100 each season (3.3% of all sharks species caught). The porbeagle catch rate was 0.5, with about 4,800 caught (South of 39° South latitude) representing 5.5% of all species caught. At a time when, although finning had been banned, there were no restrictions on the quantity of sharks being retained or perhaps killed in order to recover hooks, at least 75% of sharks caught were released alive: Between 1991 and 1998, from observation of 9% of fishing effort, 25,000 of 32,314 blue whalers, 1,100 of 1,894 porbeagles and 38 of 44 crocodile sharks were released alive (the status of a further 11% was unknown) (Hobday et al 2004). But, the extent to which the presence of an observer may have influenced the fate of sharks caught must be considered.

Catch rates on Australia's east coast varied from around 1.3 sharks per 1000 hooks between 10 and 30 degrees south latitude, to around 7.7 between 40 to 50 degrees south. **The best estimate of the catch rate average of all shark species in the fishery was around 5.5 per 1000 hooks.** This is a rough estimate based on Australian Commonwealth Scientific and Research Organization unpublished data from a subset of the fleet and time period, and is possibly not representative of the entire fleet. Most recently, data collected from 4% (402 sets) of observed fishing effort by Dambacher (2005) indicate that in 2004/05 discarded shark catch rate was around 1.3/1000 hooks, (this figure derived from patchy data with respect to area and season). Of the 504 individuals of 17 species (sharks and rays) observed discarded, 84% were alive. The three most commonly caught were blue whaler (47%) pelagic ray (17%) and Mako (10%), with the next most abundant at around 3% being Hammerhead, Manta ray and Oceanic white-tip. If these data could be reliably used to calculate total annual catch, it would be around 12,000 sharks (1.2/1000 hooks) representing 4.6%, by number of all fish caught in the fishery. However from these data it is not possible to ascertain what actual proportion of sharks caught were either retained or discarded. Although there is some degree of uncertainty about the accuracy of shark catch rate overall,

even if this was 5.5 per 1000 hooks as has been suggested, vessels would seldom reach their maximum trip limit (even if they kept every shark). It is possible therefore that aside from shark retention rates perhaps declining simply because of the influence of legislation on attitude, the restrictions of the legislation alone may in fact have had little bearing on shark conservation. But it is necessary to remember that without regulations shark catch can be dramatically increased deliberately and can vary substantially from day to day.

The biological implications of catches are potentially complicated by the fact that, at least for blue sharks, whilst known to have an extreme but variable distribution throughout tropical and temperate waters, they display very apparent sex and size segregation. Furthermore the impact of this fishery on pelagic sharks cannot be calculated due to the restricted time series of catches and effort data (Stevens and Wayte 1998). There was no consistent trend apparent even for the species caught in greatest numbers, the blue shark. This species of shark is however considered likely to be the most resilient to fishing pressure. Although Stevens and Wayte (1998) state that at the time the majority of pelagic sharks are finned and the carcasses discarded, no data were provided on the life status of sharks caught subsequent to the 1991 requirement that for finning to be practiced, the whole carcass had to be retained. If, as is reported, the 1991 requirement 'effectively prevented them (the vessels) from retaining shark fins whilst in Australian waters', then the high survival prospects (Moyes et al 2006) of post release sharks would obviously have contributed to there having been no apparent trend in abundance as a consequence of fishery impact (based on observed catch rate data in the five years subsequent to 1991). And in New Zealand where similar amounts of the same species were being caught and actually processed for their fins throughout the 10-year period, impact of this is thought to not have had a serious effect on shark stocks (Francis et al 2001). Over a period of approximately 10 years (1990s) Australia's domestic longline fishery had the unrestricted option of utilizing all sharks, even just for their fins. Whether this has had any bearing upon present day shark catch rates is not known.

Five species, great white, grey nurse, megamouth, green sawfish and Herbert's nurse shark are prohibited take and of these there have been 5 grey nurse and one great white interaction recorded in pelagic longline fisheries in Australia.

### **A1.6. Influence of International Initiatives on Domestic Shark Management**

Various international fisheries management initiatives have been influential or instrumental in subsequent national initiatives in Australia for improved fisheries management, including the management of shark bycatch. For example, the United Nations Food and Agriculture Organization produced the 'Code of Conduct for Responsible Fishing'. In 1999, Australia ratified the United Nations Agreement for the Conservation and Management of Straddling Fish Stocks and Highly Migratory Fish Stocks, and became a party to the United Nations Convention on the Law of the Sea. Australia is a signatory to the Convention on International Trade in Endangered Species (CITES), which can mean an obligation in relation to particular shark species. Australia has produced a Shark Assessment Report (SAR), a requirement of member nations in response to the Food and Agriculture Organization of the United Nations International Plan of Action on sharks. The SAR identifies conservation and management issues associated with shark catch, the most significant of which are those including target, byproduct and bycatch. There were 24 priority requirements identified. They included better recording of all shark catches, protection of species with poor conservation status, cross jurisdictional management of stocks, national controls on shark finning, the need to develop shark bycatch reduction methods, handling practices of returned catch, ecosystem effects of shark management practices (specifically trophic cascade), impact of increased shark populations, impact of prey removal and the impact of market demand on shark populations.

Australia's management of the practice of shark finning is also consistent with its obligation to the United Nations Food and Agriculture Organizations Code of Conduct for Responsible Fisheries to fully utilize bycatch and by product species. This practice is reiterated to signatory nations to the FAO IPOA sharks, in that incidental shark capture should not result in waste, and capture of non-utilized species should be minimized. Australia is also a member of Regional Fisheries Management Organizations such as the Indian Ocean Tuna Commission (IOTC) and the Commission for the Conservation of Southern Bluefin

Tuna (CCSBT) under which shark bycatch management specifically can be further addressed. For instance, within such processes, Australia entered into a Bilateral Shark Bycatch Code of Practice agreement with Japan, the objective being to ensure all sharks taken are either: released alive and undamaged ((i.e. not mutilated or cut prior to release), or retained whole, not just fins and killed first before being processed.

### **A1.7. National Management Processes for Sharks in Australia**

Commonwealth fisheries bycatch is managed by several procedures such as by a direction and/or a specific inclusion within a statutory Management Plan, as a condition or a bycatch regulation prescription of a fishing permit, through an urgent temporary order or as a prohibition against the take of a particular species in the Fisheries Act.

Increasing catches of sharks and the inherently low productivity of sharks are the reasons for concern, not just in Australia but also worldwide for populations of some shark species. But, the relatively low market value of sharks is considered to have been the reason why few countries have managed shark catch in the past (SAG and Lack, 2004). Without appropriate management in place to prevent or at least contain increased exploitation potential, today's bycatch (discarded sharks) can become a by-product tomorrow as determined by a changing market demand. From a scientific perspective, management of pelagic sharks is complicated by the unknown effects on the oceanic ecosystems of removing large number of these top predators. Also, because sharks have historically been of low economic value in most countries, data quality has been poor.

The above situation precipitated development of the International Plan of Action for the Conservation and Management of Sharks (FAO 1999), to which Australia responded by establishing a Shark Advisory Group in 2000 for the purpose of developing a shark assessment report which was released in 2001 (Rose and SAG 2001). This report highlighted the necessity for development of an Australian Shark-plan (SAG and Lack 2004) 'to ensure the conservation and management of shark resources and their ecologically sustainable use'. Specifically related to fisheries impacts, the main objectives of the plan were to ensure sustainability of target and non-target catches, to minimize incidental catches of sharks that are not being utilized and for those that are utilized, minimize waste such as when fins only from the shark are retained, in accordance with article 7.2.2 of the Code of Conduct for Responsible Fishing (FAO 1995). The NPOA—sharks provides a guide to incorporating shark conservation and management issues into the various fisheries management plans. It recommends examining the methods used to manage and reduce shark by-catch.

The pelagic longline fishery was identified as a potential source of significant shark catches and attempts have been made to evaluate this in order to develop a management response. Hobday et al (2004) undertook an ecological risk assessment of the main portion of this fishery in Australia. The fishery now operates under management plans, the performance of which must be assessed at least every 5 years (AFMA 2005). Under the management plan, a bycatch action plan (AFMA 2004) must be prepared, and implemented and for as long as it is in force it must be reviewed at least once every second year. The management plan also stipulates that ecological sustainability of each primary species and secondary species in the fishery be assessed and reference points established (precautionary limits must otherwise be set) within 24 months of the plan's commencement day. This is consistent with the primary objective of fisheries management here (in Australia): to maintain an ecologically sustainable harvest rate of target, by-product and by-catch species. After the policy mandate for management of fishing impact on non-target species (MCFFA 1999) a bycatch policy was adopted (commonwealth of Australia 2000).

Sharks under the management plan are referred to as secondary species where they are considered by-product with a 20 carcasses per trip limit, after which they are bycatch and any subsequently caught must not be retained. This trip limit was imposed as a precautionary response under the Fisheries Management Regulations 1992 to high market value of shark fins and the largely unknown status of shark stocks. The measures in the Management Plan aim to minimize the impact of the fishery on sharks by

reducing the levels of bycatch and the incentive for targeting of shark species generally, including on the high seas by Australian vessels.

Shark bycatch issues highlighted by SAG and Lack (2004) that are most relevant to pelagic longline fisheries were the need to reduce or eliminate shark by-catch, shark handling practices, the necessity for all dead sharks to be fully utilized and reliable assessment made of catch rates and the extent of utilization (fate of bycatch). Barker and Schluessel (2004) highlight the complications of managing oceanic, highly migratory species, an issue also identified in SAG and Lack (2004) with some initiatives proposed whereby shark stock shared with other nations may be managed.

The Southern Shark and South East Non-trawl Fishery Bycatch Action Plan (2001) and The Commonwealth Policy on Fisheries Bycatch Commonwealth of Australia (2000) both refer to bycatch being that part of the catch which is discarded, or which interacts with the fishing gear but does not reach the deck but the Commonwealth Policy on Fisheries Bycatch does not include by-product under its definition of bycatch. By-product is the part of catch kept or sold that was not a prime target species. This is managed in a similar manner to target catches under various management plans, fishing permit conditions etc. Such fisheries-specific management processes can be, and have been dictated by broader processes such as Australia's Oceans Policy (Commonwealth of Australia 1998) as well as its Environment Protection and Biodiversity Conservation Act 1999 (EPBC Act). The EPBC Act for instance dictates that if a species of shark is nationally threatened then apart from the requirement that a recovery plan is prepared for that species, assessment and approval of the impacting process is required. The Oceans Policy provides a framework for marine planning and management including that of bycatch.

All Commonwealth fisheries are being strategically assessed under the EPBC Act, supposedly by 2005 and will include bycatch, which for any shark species that is protected will require that a suitable data collection scheme be in place to allow for risk assessment to be undertaken (Rose and SAG 2001). Of 47 species currently identified as species of concern (through the processes of the International Union for the Convention of Nature (IUCN) Red List, the EPBC Act, and the Endangered Species Scientific Subcommittee (ESSS), eleven of these are known to be caught in non-shark targeted fisheries. There are nine shark species specifically protected under legislation and a conservation status has been assigned to approximately 70 species. For two species, Grey Nurse and White Shark, Recovery Plans that have been prepared (Environment Australia 2000) and 2000a), do not identify pelagic longline fisheries as a problem.

Of direct relevance to the actions and objectives of the current study SAG and Lack (2004) proposed that shark-bycatch reduction measures be assessed for effectiveness and or developed, and that adoption be encouraged of those that are effective. Australia's tuna and billfish longline and minor line fisheries bycatch action plan (2004), re-iterates the relevant management guidelines contained in the nations bycatch in fisheries policy (commonwealth of Australia 2000) and provides specific time-line related processes to ensure effective ongoing management of bycatch. Tools to facilitate management under such plans include specific gear usage and changes in fishing practices, move-on provisions, as well as seasonal and temporal closures (AFMA 2004). But in an Environmental assessment of Commonwealth fisheries, there is more generally a requirement that data collection, assessment and management responses are in place for target and byproduct species, bycatch, and the broader environment. These must be adequate to demonstrate that a commercial fishery is managed in an ecologically sustainable manner, and, a guiding principle for the ecological sustainable management of fisheries is for there to be no over-fishing, so that catch levels maintain ecologically viable stock levels.

All the above processes have been necessary if only, in the absence of reliable shark catch rate and population dynamics data, to uphold the legislative objective that optimum utilization of living resources shall be achieved whilst ensuring adherence to the principles of ecological sustainability and the exercise of the precautionary principle.

The eastern Tuna Billfish Fishery Industry Code of Practice for Responsible Fishing (Jusseit and Robinson 2003), as do similar Codes of Practice that have been developed for other sectors of the fishery, gives specific voluntary mitigation advice in relation to sharks. This includes not targeting them for

fins, ensuring they are dead by severing the backbone behind the head before processing, utilizing all shark products by pursuing markets for these and for those that are released, to do this carefully so as to maximize their survival prospects including by removal of hooks and line when possible. The code also encourages fishers to provide comprehensive and accurate logbook information, an element lacking and one perhaps exacerbating concerns over the extent of shark bycatch and the species composition of this.

To further assist in shark management, there has been considerable effort devoted to providing appropriate species identification tools e.g. Last and Stevens (1994), Daley et al (2005) that will help to address the species identification deficiencies known to occur.

## **A1.8. National Regulations**

### **A1.8.1. Regulated fishing effort**

There are separate management plans, one for the south and west and one for the eastern fisheries. Although the preferred method of managing fisheries in Australia is by output controls in the form of Individual Transferable Quota (ITQ) (AFFA 2003), input control by Total Allowable Effort (TAE) was considered more satisfactory for the eastern fishery. In the south and west, control is quota based via ITQ's applying to the four main target species, yellowfin, big eye, albacore tuna and swordfish.

Fishing effort is controlled by a combination of input controls that include limited entry, area restrictions (zoning), vessel size restrictions and gear restrictions. Statutory rights (SFR) (granted based on previous effort and amount caught) which equal a set number of branchline clips are to be granted under the current permit system in which there are at present 232 pelagic longline entitlements (Hobday et al 2004). The number of effort units expended is branchline clips multiplied by SAF (sub-area factor) i.e. an effort unit can equal or exceed or be less than 1 to make fishing in an area more or less attractive. This has potential as a means of limiting impact on species, including sharks, essentially by providing incentive for operators to fish or not fish in a certain area.

Daily SFR utilization by each vessel is monitored against an annual limit (equivalent to hooks set) in each fishing season that commences on 1 July and finishes on 30 June each year. The total allowable effort (TAE) is equivalent to around 125, 000 hooks, (branchline clips) per operator (for a re-structured fishery consisting of approximately 80 entitlements) annually or 7.8 million for the fishery, 0.8 of which is to be assigned to fishing outside the EEZ of Australia. This Total Allowable Effort (TAE) will be determined each fishing season with consideration to the reference points for each primary species and secondary species. (The effort can be divided into areas for instance to maintain a species reference point). TAE is based on an estimate of total take from all users of the fishery, reference points for scheduled species, information about the sustainability of marine species in the area, the precautionary principle and any decision made by the Minister (of Fisheries) that may affect the TAE.

Obviously then, a limit on fishing effort does serve to limit catches of sharks but the impact on individual species is uncertain, which is one of the reasons that other measures to limit catches apply.

In 2006 an Australian government fishing permit buy-back incentive to reduce the total number of permits by about 30% was instigated. The impact of such a theoretical reduction in overall fishing effort on sharks etc, remains unclear because this, as a consequence will be dependent entirely upon which permits are acquired (inactive permits, of which there are many do not catch sharks!).

It is possible that, following a period of management by TAE, the preference for managing by ITQ of some or all species caught will be re-considered. The potential impact of this on bycatch species such as sharks is unclear. Consideration is also being given to imposing bathometric related limits to the shores within which pelagic longlining will be prohibited. Designed to assist managing longline target species recreational fishing this restriction on pelagic longlining could greatly affect shark bycatch in several ways: a frequent comment by fishers surveyed (see this paper) was that shark bycatch (by number) was far higher when lines were set or inadvertently drifted over more inshore (shallower) waters. Putting all longline fishing effort into more oceanic waters will alter species composition and abundance of sharks

caught, but considering the other shark management prescriptions that already apply, this may be a change of little concern.

### A1.8.2. Retention limits per trip

There can be no doubt that the retention limit of 20 sharks per trip imposed in 2004 (Hobday et al 2004) was a significant influence on the fate of sharks caught. But perhaps without a finning ban having also been imposed, the 20 sharks per trip limit may not have altered the retention rate (and so altered conservation implication of catches) much of those species that were being retained anyway. This is because seldom would a vessel, on the average duration trip (Table A1.1) actually catch this number of species whose flesh was sufficiently valuable to make its retention desirable. Furthermore, many operators only retain a shark that falls into this category if it is already dead or dying, thus safely and relatively easily landed. Mako and thresher sharks in particular fall into this category.

Table A1.1. Statistics of Australia's pelagic longline fishery.

Vessel characteristic	min.	max.	average	sample size
Number of crew per vessel	2	6	4	35 vessels
Trip length (days)	1	30	4.47	178 trips
Set length (hours)	0.25	6	3.327	531 sets
Sets per trip	1	21	3.057	174 sets
Branchline length (m)	5	28	19	26 vessels
Buoyline length (m)	4	20	11.9	26 vessels
Distance between branchlines (m)	10	60	38.15	46 vessels
Distance between hook and weight (cm)	200	800	473.2	16 vessels
Number hooks between buoys	5	30	8.44	46 vessels
Mainline length (km)	25	100	61.4	28 vessels
Minimum hook depth (m)	12	80	32.74	44 vessels
Maximum hook depth (m)	30	350	76.85	44 vessels
Number of hooks per set	90	1940	956.6	513 sets/46 vessels

Once a vessel reaches its limit of 20 landed sharks, it is a requirement that no more sharks are retained. In practice however, the fate of sharks caught remains uncertain, dependent on whether an operator pursues hook recovery (see method used to kill) from the sharks and the method used to do this.

Any caught in excess of 20 no longer fall into the category of byproduct but become bycatch and so the obligation of fishing concession holders to keep this to a minimum, i.e. try not to catch them in the first instance, applies.

But an additional consequence of a trip carcass retention limit is the potential for high grading wherein a shark retained is subsequently discarded in preference for larger or fresher, or more valuable species encountered. This has obvious conservation implications further complicated by the life history traits of such species wherein killing larger individuals (sexually mature or at a late age) is perhaps most detrimental. Fortunately, for sharks species with relatively high meat value this is likely to be not a major issue simply because total catch on each fishing trip is usually below maximum carcass limit imposed. (See survey section).

Further catch limits or reference points may be established for shark species following the required risk assessment of ecological sustainability of catches, to be carried out for all secondary species within 24 months of the management plan's implementation (2005). Shark catches may also be influenced by target species stock status evaluation (to occur within 12 months of the management plan being implemented) to establish ecological sustainability. Such a process may present the complication of how

to maintain a shark reference point whilst exploiting a target species catch rate increase, should such an opportunity be identified through stock status evaluation.

### **A1.8.3. Finning at sea prohibition**

Shark finning was banned in Australia in response to concerns over sustainability, the need to prevent finning of protected species, and the issues of waste and cruelty. In 1991 Australia banned finning, unless the carcass was retained by foreign vessels fishing inside the AFZ. However, for domestic vessels this requirement was not applied until 2000. Prior to the ban in 2000, shark finning was a widespread and common practice judging from the estimates of Rose and Mc Laughlin (2001). The ban was introduced as an amendment to the permit condition of pelagic longline concession holders that disallowed possession, carrying and landing of shark fins unless attached to the trunk of the shark.

Without finning regulations, shark fins unlike most fish products, can be easily carried in large quantities even by small fishing vessels without refrigeration. The requirement for fins if retained, to remain on the carcass until offloaded in port has essentially put an end to finning, with the exception of those from the small numbers of sharks that are primarily retained for meat. It has also assisted to ensure that the protected shark species are less likely to be killed if caught and their fins retained. But, despite this there are essentially two main motivating factors; economic return or hook recovery, that actually largely control the fate of sharks irrespective of the management processes that exist and in Australia there are a considerable number and complexity of these.

So, a combination of the shark retention trip limits and the prohibition of finning sharks at sea has greatly increased the likelihood of the preference being, to, if possible not actually catch sharks in the first instance. In those fisheries that have such shark management regulations there is therefore likely to be some interest in any practical measures of assistance to achieve this.

An additional impact of the carcass retention trip limit and finning prohibition is that now with such a low fin volume, the consequential inefficiencies in marketing further reduces incentive to retain any sharks or bother to remove fins from those that are retained primarily for their meat.

### **A1.8.4. Prohibited use of a wire trace**

Wire was used by pelagic longline fishers in Australia, as it is in other fisheries, for two primary reasons: (i) to deliberately increase retention rates of sharks with the intention of retaining them or parts thereof, and/or (ii) to reduce gear loss by sharks and other species when wire is not used. Higher risk of losing target species can be an important consequence if wire use is not permitted because of deficiencies in maintenance of damaged monofilament line between sets. Prior to the ban, instead of monofilament line, a short (< 1 m) length of usually multi-strand stainless steel wire was incorporated between the hook and a swivel, beyond which the remainder of the branchline extended to the mainline clip.

Use of wire was recently prohibited in Australia, the intention being that a greater proportion of sharks caught would now escape the mono (relative to wire) which would be more likely severed. This, to a certain extent removed the option that fishers otherwise could exercise of killing all sharks to retain or to recover hooks. It is true that for a fisher who only wants to discard all sharks and is unconcerned about the extent of hook loss, mono, not wire to the hook does provide easier discarding opportunity. But, the likelihood that many of such discards are left with long sections of mono trailing (as well as the hook) is high. The long-term health implications of this are not fully understood although the anecdotal evidence (see survey results) is that, to a shark, such potential impediment is of little or not consequence.

The majority of fishers surveyed did not consider hook recovery from sharks warranted and, if given the option they would not elect to incorporate wire. But opinion varied with wire being considered an essential tool to make fishing viable where bycatch species that are particularly destructive to fishing gear (sharks, snake mackerel, wahoo lancet fish) are prevalent. Without wire, fishers commented that it was easier to discard sharks that are caught efficiently by cutting the mono near the hook, despite loss of all hooks by doing so. This contrasts to the practice in those fisheries where despite similar shark retention and finning restrictions, wire usage is still permitted. Here a common practice with wire is to use it to advantage and recover all fishing gear, including hooks. This is made possible because, under tension (a fish on the

hook) wire, unlike mono has no elasticity. A shark can therefore be more easily controlled with safety and in doing so all fishing gear, including the hook is invariably recovered, with frequent, time-consuming costly shark damage repairs greatly minimized. (A high, elevated work deck on a vessel does limit this capacity, however).

There is potential therefore in fisheries where the use of wire is permitted, for improvement in shark conservation although this can be reliant to a large extent on:

- The existence of other measures to constrain the extent to which sharks that are caught can be retained; and
- The attitude of individual fishers to sharks and the measures they choose to take to discard them when caught. An important component of this can be, as it is in Australia, the choice or not to use firearms as a routine method to dispatch fish prior to them being landed (see following section).

Additional advantages of wire are that a lead centre swivel is generally used where mono attaches to wire. As this tends to be within 1 metre of the hook, line sink rate to avoid seabird interactions is optimized. Hook storage bin tangles that reduce fishing efficiency and exacerbate bird interaction rates are also much reduced with branch-line configuration of the above design.

In a fishery where gear damage by fish (not only sharks) is high, average trip length and fishing effort can also be an important influence on the desirability of wire use. In Australia, where average trip length is only about 4 days and daily effort around 950 hooks set (Table A1.1), the capacity to withstand substantial gear damage is much more feasible than in fisheries with considerably longer trips setting many more hooks. Daily gear damage can be so great, on voyages of extended duration that if fishing effort capacity is to be maintained throughout the trip it is more feasible to contain damage by using wire rather than have enough replacement gear. Regulations that restrict the number of clips that can be carried aboard vessels in Australia also limit this as an option. (There is insufficient time for crew to actually repair all damaged gear except on much larger vessels where sufficient crew keep pace with repair needs).

## **A1.9. Fishing Practices that Affect Shark Catches**

### **A1.9.1. Fishing location**

It would seem that shark catch rates in the AFZ particularly of blue sharks, increase in more southern waters. However, now it is a requirement that vessels fishing in this region must possess a minimum quota of Southern bluefin tuna before a longline is set in a specified period of the year. Few longline permit holders possess quota for this species. Availability and cost of quota is now prohibitive for economic longline efficiency, with the majority of quota now consumed on aquaculture of this species. This scenario is likely to have greatly reduced overall shark catch potential as it also has for seabird mortalities. Survival rates of more southerly, cold-water caught sharks may however be better due to reduced metabolic rate and lower oxygen demands (Francis et al, 2001).

Questionnaire respondents considered that line setting inshore (often by unintentional line drift) of the continental shelf break greatly increases shark catch rates and where this is a known consequence, this region is generally avoided. As noted previously, consideration is currently being given to applying longline fishing restrictions in relation to waters adjacent to or over the shelf break. But, this is not being driven by any perceived need in relation to shark management. Shark catch rate and species composition of the catch will change because of this. Evaluating the extent of fishing effort in relation to this area factor for shark interactions, based on existing logbook and observer fishing position records would be of value.

### **A1.9.2. Line set, soak and haul duration, depth and timing**

The average number of hooks on a longline usually has a direct relationship to duration of line setting and hauling. The interval between setting end and hauling, referred to as 'the soak', has no real relationship to fishing effort (hooks set) in this particular fishery. But the combined duration of these events can, not only



alter catch rate but survival prospects for species that are discarded. Francis et al (2001) attributed higher shark survival to less soak time and hauling duration because of shorter mainline length. Average setting, and hauling duration of Australian vessels (Tables A1.2 and A1.3) are likely to be factors improving condition of bycatch species, provided these are subsequently discarded with 'survival' being the intended outcome.

Table A1.2. Timing of setting and hauling operations by the Australia longline tuna and swordfish fishery.

Time of Day	Start Set	End Set	Start Haul	End Haul
	No. Vessels	No. Vessels	No. Vessels	No. Vessels
0100	13	15	7	16
0200	10	13	9	12
0300	13	18	13	12
0400	14	12	16	8
0500	9	17	39	4
0600	19	7	77	7
0700	14	12	82	9
0800	19	9	47	8
0900	28	23	27	10
1000	20	14	21	16
1100	13	18	18	22
1200	17	20	15	48
1300	24	25	2	47
1400	9	13	18	47
1500	25	19	19	56
1600	56	21	9	33
1700	50	19	29	40
1800	64	14	31	20
1900	40	31	16	18
2000	18	49	15	16
2100	18	52	10	16
2200	15	64	10	18
2300	12	37	6	28
2400	19	18	5	20

Table A1.3. Time interval (hours) between the end of line set and start of line haul – the ‘soak’ from a sample of 541 observed sets.

<b>Soak Time (hours)</b>	<b>No. of Sets</b>
1	2
2	5
3	8
4	27
5	42
6	67
7	65
8	95
9	91
10	66
11	38
12	14
13	13
14	1
15	3
16	2
17	1
18	0
19	0
20	0
21	0
22	1

However, despite the average line length (and extent of set) being relatively short, with comparatively few hooks (Table A1.1) typical duration of soak (sleep time for fishers) is long (Table A1.3). There has not been an impact evaluation of this particular fishing time partitioning on discard condition.

Respondents to the shark survey indicated that time of day significantly influences shark catch rates, with an unavoidable correlation between when and where sharks as well as target species will be encountered. With increased hook immersion time in darkness, there also is an increased shark catch rate.

Again, there is little actual understanding of the typical daily fishing routine on bycatch rates or the subsequent condition of bycatch when discarded. A better understanding of this is necessary because, when considered along with gear characteristics (Table A1.1) such as relatively short average buoyline length, few branchlines between buoys that have contributed to an average maximum hook depth of only around 80 m, a reassessment of alternative parameters may actually improve target catches but reduce bycatch of species such as sharks that may be more active in shallower depths at night.

In the absence of reliable use of alternate and more successful seabird mitigation measures in Australia’s pelagic longline fishery, mandatory night setting could be inevitable. A change in shark catch rates will be a likely consequence but existing management prescriptions are likely to be still adequate, again, provided discarding occurs with ‘survival’ being the intended objective.

If it is true that most gear is un-weighted and even when it is weighted this is at considerable distance from the hook, (see line weighting and Table A1.1) than the influence of shoaling (Bigelow et al 2005) combined with a shallow line setting depth average anyway may be significant, and cause more sharks to be caught. Relevant to mention here is that, currently efforts to contain high seabird mortalities in this fishery south of 25 degrees south latitude include specific line weighting prescriptions (DEH 2005), the

influence of which is uncertain on shark catch rates, particularly when combined with a seabird bycatch reduction-driven shift to night time only, line setting also.

From late 2005 vessels specifically altering fishing strategy to target fish at greater depth have reported a corresponding decline in catch rates of non-target species, including sharks. So far, this change in fishing strategy is not widespread.

#### **A1.9.3. Bait type**

Perhaps not so common elsewhere in pelagic longline fisheries is the widespread dependence on baiting hooks with live fish in Australia. The catch rates of sharks when using conventional thawed bait compared to when using live bait has not been evaluated, although respondents to the shark survey with live bait experience gave a mixed response to the question. When squid is used for bait, light sticks are generally also used. Respondents to the shark survey (survey section) gave mixed response to both questions relating to shark catch on lights sticks and to bait type but were not questioned on bait type specifically with or without a light stick. Weight of opinion was however toward squid and light sticks exacerbating shark catches. If observer records from 402 sets by vessels that used light sticks are any indication, the number deployed is high, with an average of 605 per set. But from the records the overall percentage of sets in which light sticks are used is unclear.

#### **A1.9.4. Line weighting**

The AFMA observer database of line weighting characteristics in this fishery suggest that, unless the presence of a weight went un-recorded, most vessels do not use any branchline weight. In a 47vessel sample, 15 used weight, either 38g or 60 g with 2 using 100g at an average distance away from the hook of 4.7 m. As previously mentioned, line setting depth (and therefore perhaps shark catch reduction potential) may increase when lines are more heavily weighted in an effort to reduce seabird mortalities (DEH 2005).

#### **A1.9.5. Method used to dispatch captured fish**

Contrary to perhaps the majority of the worlds' pelagic longline fisheries, Australian operators mostly utilize the legal prerogative of firearms to kill captured fish once these are alongside the vessel. Effective, arguably more humane and beneficial to product quality, this method of dispatch is likely to be increasing the number of sharks that are killed and kept, are killed to recover the hook and then discarded or, simply killed for no specific reason other than an aversion to discarding any sharks alive. Without firearms, and taking into account potential time wasted and safety issues, the best option is discarding. In fact, few operators except some of those that use firearms consider handling live sharks viable from a safety and economic perspective.

#### **A1.9.6. Hook type**

Consistent with the trend in pelagic longline fisheries elsewhere, there is recent interest in assessing the consequence of a change to circle hooks on species catch and survival rates in Australia. Most recent data on hook type usage are from only 23 vessels, 20 of which were using 'J' hooks of various sizes, two were using circle hooks and one vessel had a mix of both types. It will be some time therefore before any conclusive evidence may emerge in relation to hook type performance in this fishery. Although there has been some evidence that circle hooks may actually catch more sharks (Ward et al., 2005), fish caught on circle hooks are likely to be less damaged by the hook, (Faltermann et al., 2002; Watson et al., 2005).

### **A1.10. Survey of Shark Fishing Practices, Handling Strategies, and Fishers' Opinions of Sharks and Shark Management**

#### **A1.10.1. Methods**

Between 1 January and 16 February 2006, nine fishing ports scattered throughout the entire latitudinal extent of the east coast pelagic longline fishery were visited with the objective of conducting interviews with individual fishers and fleet managers. Because shark bycatch can be a controversial and sensitive issue for fishers to discuss, input of a meaningful nature to the survey was generally sought from those in

the industry with a prior reliably cooperative record. Whilst not all those interviewed were still actually fishing, all had done so while the most recent shark-specific management conditions have applied. Interviews were conducted individually and the duration required was generally from 60 to 90 minutes. Initially the survey comprised 62 questions but was progressively modified to be more relevant, appropriate and comprehensive with consideration to information provided by the respondents. Answers have been provided for 49 of these questions. Of those interviewed, three were fleet owner/managers and one was an owner/manager who also fishes. These interviewees combined, control 1/3 of all vessels in the fishery. Eight others interviewed were owner/operators and a further two worked on vessels that they did not own. Although confidentiality in relation to participation was offered, all respondents had no hesitation in indicating that this was not necessary. To be expected in a survey of this nature, much useful, relevant information not canvassed, was forthcoming. Much of this additional information has been incorporated into the results of the survey.

As a means of putting the practicalities of the Australian longline fishery into world context, a profile of the Australian vessels and their methods of operation was constructed. Because no such summary of current fleet characteristics seems to have been previously collated, information was sought from the AFMA observer database (Table A1.1) of vessel, gear and fishing activity throughout 2005. Data of this nature over a longer time interval were not considered indicative of current gear and/or operational characteristics because these have changed in response to recent regulatory requirements. The operational and gear characteristics were considered in relation to their potential effect on shark catch rate and handling practices.

Also undertaken, was a review to put pelagic Australian longline fishery shark catches and utilisation into perspective with consideration to other fisheries, management means and measures.

#### **A1.10.2. Survey results**

It was obvious that the attitude to sharks both in terms of economic incentive to utilize or not, was somewhat dictated by latitudinal change in species presence, their abundance and how this alters the extent of negative economic consequences from gear and target species destruction. Sharks caught by pelagic longline fishing in Australia fall into three categories of economic relevance to operators: to some they are considered equal component of target species catch composition: to others they are treated as by-product only and largely as a consequence of logistics (tending to mostly land and retain individuals in already dead or near-so condition). The third category into which sharks that are caught fall is that of bycatch whereby operators have no inclination to retain any, and take the safest and quickest means of discarding them. However, all or most survey respondents agreed that their attitude to the sharks that they catch is largely a financial consideration, in that if it was economically worthwhile with established markets and unrestricting regulations, sharks would become a bycatch species of importance to the extent that some operators would actually target them more with appropriate gear changes. Regardless, most respondents were of the opinion that shark-specific regulations have had little or no impact on the nature of and extent of their interactions with sharks. This is because they would seldom have the opportunity to exceed the existing 20 shark per trip retention limit of species that are of sufficient value to make retention worthwhile (unless those species with little or no market value were to become economically attractive to retain).

In Australia it would seem that the shark-specific management prescriptions, particularly those of finning and a per-trip retention limit has altered the way in which sharks are handled by 50% of operators, but the regulations do not preclude routine killing of the sharks that are caught. Also, irrespective of the current attitude to finning, historical data do suggest that without specific regulations preventing this, sharks would be killed for their fins alone by many operators.

In the Australian fishery, where an accepted and widespread method used to kill fish is with a firearm, most operators were of the opinion that this practice alone can result in the death of significantly more sharks that are not in any way utilized. Several operators, whilst personally disinclined to do so, indicated that other operators do kill all sharks, if only to safely recover hooks that are otherwise lost as each shark is cut free. But on many vessels, (over 1/3 of the fleet) the safety concerns associated with firearms aboard outweigh any perceived safety or operational advantages of firearms use (57% of respondents).

Of the respondents, over half would elect to use wire traces to some degree if free to do so (use of wire traces is not permitted in the fishery). Reasons for this preference varied from this being considered a necessity in lower latitudes owing to:

- The extent of gear damage and therefore lost fishing efficiency caused by sharks, lancetfish, snake mackerel and marlin, if wire is not used; and
- The fact that sharks here are an economically viable target catch.

Elsewhere, operators considered that intermittent wire use could deliberately allow for capture of a specific individual shark (as opposed to it being able to bite through a nylon trace), which would otherwise cause considerable economic loss by biting off hooks or destroying, caught target fish. Several respondents were of the opinion that if wire use was widespread, then with more sharks caught, larger numbers in total would die. It is perhaps worthy to note that in other fisheries where firearms are not the selected method used to despatch fish on hooks and where wire traces are permitted and widely used, there are some advantages, and not just disadvantages, to sharks from using wire. For example, operators become proficient at retaining all their fishing gear when a shark is caught because the wire from the hook to a 45g or 60g swivel (about 600mm or less away), allows for greater control with much improved safety. (Wire is more likely to not part from the fish under tension and being less elastic (compared to nylon under tension) is not so dangerous). Thus, sharks are generally released in good health alongside the vessel with the fishing gear recovered and un-damaged. Also in parts of Australia the daily gear damage because wire cannot be used is considered economically and/or operationally unacceptable. But one reason given for a preference not to use wire, if free to do so was that shark handling time and increased difficulties in discarding sharks are unacceptable.

Half the respondents do not consider any effort to retain sharks or recover the gear (hook) from sharks is worth it because economic loss from this will always exceed the little revenue derived from retention of sharks. (Table A1.4) (Aside from the associated risks to crew from handling sharks). In fact, potential injury to crew (less of a consideration if firearms are used to kill fish) was an important consideration dictating the fate of sharks caught.

Table A1.4 . Summary of opinions expressed by survey respondents on how to minimize or increase shark catches.

Strategy	Less Sharks	More Sharks
Set on the cold side of a thermocline	√	
Light stick use (esp blue)		√
Intermediate mainline floats		√
Circle hooks (mouth hook only)	√	
Live bait use	√	
Set hooks deeper	√	
Talk to other vessels	√	
Larger bait size		√
More oily bait (pilchards)		√
Use wire trace		√
Discharge burley during set	-	(maybe)
'J' hook use		√
Shorter sets	√	
Use artificial baits (limited data)	√	
Firearms to dispatch fish		√
Avoid known high shark densities	√	
Set and haul hooks in daytime	√	

If operators were intent on landing and processing all sharks caught, the revenue from this was considered by half the respondents insignificant when offset against the time lost and crew safety

compromise involved. Time lost has the following important consequences: (i) The longer it takes to haul a longline the more likely it is that target catch will die or be damaged, which reduces its value; and (ii) Increased time taken to haul a line can have a repercussion on subsequent fishing effort potential and/or the appropriate timing of this to maximise target species catches.

Here it is worthwhile to note that only one respondent operates in a fishing ground with a 500 hook per set limit imposition (a game fish catch and release alive, management strategy). As the average number of hooks set (which equates to time and this is thought to determine a fish's likelihood of survival if discarded) in the fishery is nearly 50% more than this, it would be interesting to compare shark catch data here to quantify the relationship between the number of hooks set on a line and the survival or otherwise of sharks (and other species). And, whilst there are obvious problems in comparing species catch rates across different fishing grounds, there can be (on average) more than twice this fishing effort per line (and therefore time) elsewhere. The question here is whether species survival and discard rates alter as a result of increased hook numbers set (and the increase in total set time). Obvious economic and operational efficiency issues arise in relation to the impact of a change of this nature on target species catches.

While all respondents agreed that more sharks can be caught if a wire trace is used, avoiding setting hooks in certain areas such as on the east coast continental shelf, setting hooks at a greater depth or avoiding especially oily (pilchards for example) or larger baits (especially squid) were all factors believed to help reduce sharks catches. Of all respondents, two had experience in using artificial baits and both considered them ineffective for catching sharks compared to conventional baits. But, the suitability of such bait for target species catches is the other factor of importance.

Respondents who considered that the use of light sticks (also referred to as "shark sticks"), caused higher rates of shark capture were strongly of this opinion, but had different views about which color correlated most to high shark capture. Light sticks in blue, yellow and green were all suggested to be colors, which increased shark catch, rates. But surprisingly most did not consider the act of burleying (to deliberately discharge offal and or spent bait) had any bearing upon shark catches. In relation to this point it would be of value to ascertain whether shark catch rates increase as fishing effort persists in the same location, potentially as a consequence of shark aggregation in response to persistent offal discharge. This may be of relevance in those fisheries where strategically discharging offal is actually a requirement, one entirely at odds with its objective of assisting to minimise seabird interactions. Likewise, there is a relationship between hook box tangle decrease (hook box tangles cause more birds to be killed) and branchlines configured with wire to a 45 g or 60g swivel at less than 1 metre away from the hook (a faster bait sink rate to avoid birds). The logistics of retaining fishing gear whilst successfully discarding live sharks is much improved too. Put simply, wire and an appropriate size swivel near each hook can be used to achieve several objectives, less birds killed for two reasons, more sharks released alive with more fishing gear retained and perhaps even fewer sea turtles killed because gear sets and stays set at a consistently greater depth (this too will keep shark catches down). One respondent also pointed out that heavy swivels are too dangerous to use unless wire can be incorporated, an additional issue of specific relevance to management decision-making with multiple not single species bycatch reduction objectives in mind.

Even without a reduction in the incentive for operators to not catch and retain sharks as a consequence of regulations to limit this, all operators believed that shark catches could be increased by 100% or more if they chose to do so. This ability was thought to be relevant in the debate over the actual abundance of shark species as indicated perhaps by catch rate on hooks set to target other species.

Opinions on how to minimize shark captures in the first instance, included not re-setting in a location found to contain a lot of sharks at that time, confining the set and haul to daylight, and inter-vessel alerts to problem waters, (these areas being unpredictably changeable). In a locality where target species occur in addition to sharks, as is often the case, several respondents considered sharks could be avoided and target species still caught by setting the line at greater depth. The most prevalent opinions amongst respondents as to how survival of sharks that are caught could be improved, included keeping line sets shorter, to not use wire (otherwise more will die on the hook before hauling) and to not have guns aboard.

Hook type, considered by most to be either an unknown or irrelevant factor for its impact on shark catches was by several respondents implicated in altering the way in which sharks are actually hooked (and therefore ease of release or for hook recovery). 'J' hooks catch and hold more sharks whereas circle hooks tend to mostly mouth-hook sharks, making these easier to release, hooks more likely to be recovered, and the survival prospects of the shark improved.

Most respondents consider sharks to be responsible for their greatest gear damage and economic cost, giving average estimates of this to be around AU\$100 per set but also estimate that target species economic loss could be up to 20% of catch. For those who considered sharks to be less problematic than other causes of gear or economic loss, pilot whales, lancet fish, snake mackerel, marlin, sunfish as well as crew were listed. Pilot whales were described as being considerably more destructive, but not so consistently as sharks. They were seen to be a greater potential problem locally and where this is so, no problem is greater!

Most respondents considered the act of gaffing sharks alongside either to retain a shark, or recover fishing gear in the process of discarding the shark to be dangerous and unacceptably time-consuming. Similarly, it was considered inefficient to deal with sharks by trying to use de-hookers or line-cutters, with these increasing safety risks by trying to do so. Several respondents however do use specific line cutting devices, ones that make cutting away the hook from the fish possible with the least amount of mono-line still attached. Wire trace does preclude this, but with a wire trace it is more viable to bring the shark alongside so as the hook and wire can then be disconnected from the shark. Most operators do however, prefer to reduce time and safety risks by simply cutting with a knife the mono near to, or at the shark, which results in the hook being lost. One respondent raised concern over the relationship between hook metal (corrosive or non-corrosive) type and its role in influencing the ultimate survival of released sharks.

Whilst there was uncertainty about the survival prospects of sharks that have been caught and released, all respondents considered 80% or more of the sharks they catch do survive the experience (many times over with up to 7 hooks in the one shark being recounted). Whether those that survive multiple hooking are ones that have simply bitten off baited hooks before actually being restrained by the next hook taken is not known (compared to a shark that takes its first hook and remains on this hook until subsequent release.) Most respondents were of the opinion that for each shark that they catch, between 10 and 50 more sharks either escape (bite-off) the hook or are successful in taking the bait from the hook.

Most operators considered they had not been disadvantaged economically by the imposition of shark catch-specific regulations because the limits imposed by regulation exceeded the numbers that are retained if caught. (But conceding that this is a market driven situation as in: if shark products (fins etc) were valuable enough and regulations were not restrictive, generally operators would retain (kill) the sharks caught.) The above attitude is somewhat different in more tropical waters where a combination of shark and other fish species destruction to fishing gear make use of wire highly desirable and so increased economic potential from sharks possible. Also, most operators would exercise the option, if available to deliberately exploit the sharks that are caught as a means of offsetting occasions of poor target species catches, if for no other reason than to ensure their crew derived at least some financial return for their effort.

The uncertainty about the implications of sustaining 100 or 200 hook bite-offs (hooks lost) by sharks per set, to fishery management on the proposed (at the time of the survey) basis of daily per-vessel fishing effort limitation and monitoring of this was of concern. With the proposed effort limit being the number of branch line clips carried, operators were unclear as to how they were going to be able to maintain a consistent daily fishing effort when sharks could have such a dramatic impact on gear. That is, how would there be an excess of branchline clips permitted, sufficient to accommodate the fact that the rate of hook loss could exceed their ability to effect repairs between subsequent sets in order to maintain the desired/daily fishing effort.

Shark management regulations have a mixed impact with half the respondents having changed the way in which they deal with them. 50% of respondents were of the opinion that the regulations have been an

economic disadvantage because the preference is that sharks should be utilized. Opinion was unanimous in that, because species other than sharks are the target objective there is little that can be done to reduce or avoid the average shark catch rate encountered. But all were of the opinion that there are effective strategies to avoid high interaction rates with sharks (see Table A1.4).

The majority (79%) do not believe that fishing has impacted on any species of sharks and similar numbers thought there is little relationship between the frequencies of each species caught and its true abundance. One reason proposed for this is that tooth structure differences between species affect relative rates of capture (i.e. some bite lines and escape much more readily). 79% considered the practice of utilizing only fins from sharks to be potentially detrimental to shark populations. However 65% did consider that utilizing such products of value when the flesh has little or no value was legitimate. The species of sharks considered by respondents to be most commonly caught was consistent with the literature on this aspect of shark bycatch in the fishery. Variation in which species is most frequently caught is likely to be inevitable considering the latitudinal extent of fishing activity. Seven respondents mostly catch blue whalers, 3 mostly catch bronze whalers, 2 mostly mako, 1 mostly black tip and 1 other mostly hammerheads. Not surprisingly, there was a similar distribution of opinion in relation to which species is the most destructive economically. For Australian fishers they could see little benefit of strict local shark management of species that are likely to range widely if regulations pertaining to adjoining fisheries are non-existent.

Respondents were all somewhat frustrated by the nature of this survey because the answers that they wanted to give were often shark species specific, and found that any attempts to generalize tended to misrepresent reality. There were concerns expressed about the lack of regard by management toward the issue of 'trophic cascade'. Their concerns are that because the majority of sharks (unlike target and other bycatch that can be retained in unrestricted quantities) are released, this creates an imbalance and their perception is that there are then more sharks to further impact on the abundance of other fish species.

It would seem likely that, considering the opinion of most in this survey where specific shark management regulations apply, that unless such regulations exist, any strategy to avoid sharks would be of little interest simply because of the economic incentives of retention.

Below we provide a summary of the responses to survey questions:

1. Do sharks have a positive or negative economic role in your fishery?

Positive	Negative
5	9

2. Have shark management regulations changed the way you deal with sharks?

Yes	No
7	7

3. Without shark regulations would you be better off economically?

Yes	No
8	6

4. Without regulations do you think sharks would be worse off?

Yes	No
8	5

5. If you could avoid shark capture altogether (or mostly) would you be better off economically than if you could fully utilize the sharks that you do catch?

Yes	No
3	11



6. In your experience are sharks nowadays more or less abundant – all species?

More	Less	Same
3	3	8

7. Is shark damage to your gear a concern?

Yes	No
12	2

8. If of concern, is this mostly for the extra time and effort to repair or replace gear, or for the actual cost of gear, (hooks line, swivels) lost to sharks?

Gear	Time	Both
4	4	6

9. Would your preference be, if possible:

(a) To avoid shark bycatch ?

(b) To not avoid it, (if free to fully utilise them?)

Avoid	Not
3	11

10. Is the income to your boat from sharks shared in the same way as all income generated?

Yes	No
8	6

11. Would this be the case if you were free to make use of all sharks caught?

Yes	No
14	0

12. Do you fish differently (bait type, timing, position of sets) because there is greater incentive for you to avoid shark capture?

Yes	No
11	3

13. Do you fish in any way that you think minimises the numbers of sharks that you catch?

Yes	No
13	1

14. Are there any things you consider may further reduce shark captures or improve your efficiency in dealing with the ones that are caught?

Yes	No
0	14

15. Do you use devices designed specifically to help release bycatch such as sharks?

Yes	No
7	5

16. Are you aware of devices that are not in use that may be effective for discarding sharks?

Yes	No
0	14

17. Provided appropriate regulations in relation to retention and use of sharks were in place, do you think that the option of incorporating a wire trace at the hook would potentially be advantageous or not:

a) to economic impact of sharks?

b) to ultimate conservation outcome to a shark that is caught?

	Yes	No
a)	6	8
b)	3	11

18. Do you think that any impression gained of distribution and abundance from shark capture rates by fishing vessels in your fishery is realistic?

Yes	No	Uncertain
1	12	1

19. If shark flesh has little or no economic value do you think that deriving income from parts such as fins or oil alone is legitimate?

Yes	No
9	5

20. Are the strategies you use to improve the survival of sharks that you do catch beneficial?

Yes	No
11	3

21. Is losing or damaging gear to sharks of any concern to you? –the loss of a hook, mono, swivels, time, fishing effort?

Yes	No
13	1

22. Do you think that to burley (for attracting fish) or routinely discard offal and/or used bait whilst line-setting increases shark bycatch?

Yes	No
8	6

23. Are less sharks attracted when using live bait?

Yes	No	Uncertain
4	6	4

24. Is where you encounter your target species the same as where shark abundance is high?

Yes	No
11	3

25. Are you able to predict the relationship between where target species and sharks can be caught?

Yes	No
5	9

26. If you knew more about the relationship of shark abundance to environmental factors could this help you to avoid sharks?

Yes	No
5	9

27. Do shark catch rates affect your target species catch rates?

Yes	No
9	4

28. What species of shark do you most commonly catch?

Bronze whalers	BLW	Mako	Bktp
3	7	2	1

29. Are there any species more destructive to your fishing than sharks?

Yes	No
5	9

30. Do you think that the abundance of species that you catch gives an accurate or inaccurate indication of their overall abundance?

Yes	No
6	8

31. If there were no regulations such as those for finning sharks, do you think that bycatch rates and retention rates would pose any threat to shark populations?

Yes	No
11	3

32. Would you prefer to be allowed to utilise all sharks caught?

Yes	No
9	5

33. Have you any experience of specific hook size that is beneficial or detrimental to shark catch rate?

Yes	No
5	9

34. Are more sharks likely to be caught if light sticks are used?

Yes	No
10	4

35. Do you think that more sharks can be caught with certain bait types or size?

Yes	No
10	4

36. Could you increase shark catches by deliberate actions to do so?

Yes	No
13	1

37. If you deliberately targeted sharks would, doing this decrease your target species catch rate?

Yes	No
13	1

38. Is it most efficient to discard sharks and retain hooks by using de-hooking methods over the side?

Yes	No
10	4

39. For each shark that you catch do you think many more baits and hooks have been lost to sharks?

Yes	No
12	2

40. Do you think most sharks that are released alive survive?

Yes	No
14	0

41. If allowed would you use wire?

Yes	No
8	6

42. Are the survival prospects for all shark species the same?

Yes	No
4	10

43. Do any existing shark regulations have any effect at all on your actual catch rate of sharks?

Yes	No
7	7

44. Do any existing shark regulations have any effect at all on the proportion of sharks that survive capture?

Yes	No
5	9

45. Does your revenue from sharks exceed the cost of catching them (gear, bait loss, and therefore perhaps target species catch rate reduction)?

Yes	No
7	7

46. If regulations allowed, could your revenue from sharks become an economic advantage to you?

Yes	No
7	7

47. Are regulations necessary to conserve sharks from impacts of your fishery?

Yes	No	Uncertain
7	6	1

48. Shark damage to commercial catch...is it an issue or not?

Yes	No
12	2

49. How are sharks handled if they are to be discarded/retained?

<u>Method Used</u>	<u>Retained</u>	<u>Discarded</u>
Shoot then cut free		
Shoot and recover gear		1
Shoot and gaff aboard	4	
Pull alongside and cut line close as possible		6
Cut with line-cutter		1
Use de-hooker		
Gaff then haul aboard	2	
Pull alongside, harpoon	1	

### A1.11. Additional Notes of Survey Respondents' Comments

- \* Sharks are thickest on 'edge front of water tickler bubbles (these are intermediate mainline floats) 'attract ' sharks –catch more BLW's-  
-Gummy cartilage in use  
-Liver out of endeavour dogs, rough skins \$1.50-\$3.50/kg (\$2-3 /kg good-worthwhile) fuel money esp. 10 bodies  
-threshers –ok meat, no good fins. Does not worry at all about the regs? Doesn't have to because of usual low catch rate.  
- on a bad days fishing, toward the 'end' if lousy day catch he will deliberately start 'targeting ' sharks by trying to land any rather than cut them free, object being to at least cover the days fishing expenses –fuel (not bait) –dead bait at present –up to \$1.00/bait so live bait economically attractive.
- \* Recognises that it would only take a change to the value of sharks for there to be a completely different picture (except for the fact that existing regulations would curtail an escalation in 'take') Incomplete picture of species abundance because different tooth structure between species makes some more or less prone to capture or bite off. Mako more often dead on hook if have

been foul hooked. Thinks that s/s hooks, whilst remain in sharks for a 'long time' do not seem to do any harm even multiple (5) hookings with hook remaining. However with corrosive hooks, whilst these do cause damage –ulcerating etc, they at least eventually fall out. Critical of 'survey' because in his fishery the difference between shark species behaviour makes it impossible to generalize ie what applies for one species may be irrelevant for another (esp also because one species(mako) has 'high' economic value whereas others have none or little.

A disorganised shark fin purchase structure also makes it of little interest to retain them- has expressed being 'ripped off' and fin merchants are obviously not 'well established' from a business perspective.

- \* Dependent entirely upon economic value of sharks. At present only mako flesh worth handling and of this species never exceed the existing trip limit of bodies permitted. For other species caught their value does not make the handling worth it-time to land, effort, time to process, time and cost of marketing.

Summary, without regs to limit numbers kept and wire prohibition, if it was economical to do so sharks would be kept. But, not interested in only retaining fins if rest of shark of no value (an ethical versus economic dilemma) as fin value alone is not sufficient to offset time and effort to do this. Without regs, sharks would be worse off if it was economically viable to kill them.

- \* This boat lands and keeps trunks of all and any shark sp. that is easily landed. Need to be gaffed to lift aboard and gaffing sharks is not advisable –too difficult to handle (twist and turn) –break gaff, crew injuries. This boat endeavours to recover its gear (hooks) if possible from the sharks caught –over the side with a de-hooker (works ok) or if cant/wont be de-hooked line is cut with a line-cutter (not a knife)

Most important point perhaps is that if regs permitted, would use wire to offset poor target species catches (when few fish about). Does not think using wire is in any way detrimental to target species catches. Wire is effective for retaining sharks but one unavoidable consequence is that more will drown on the hook i.e. unavoidable death rate increases.

Shark catches are so highly variable that it is not possible to gain any picture of species destruction and abundance (except in relation to shelf area)

- \* All sharks that are to be kept are first shot before being landed. Generally, has no interest in the time wasted if hooks are recovered from sharks caught –far better economy to cut line with knife after the swivel and keep hauling. Makes use of de-hookers and line cutters inefficient and perhaps irrelevant. 5-10 landed per trip only so not an important part of whole fishing operation.

- \* Reckons on average trip catch and retain 8 sharks (2-3 sets)

- \* This operator places crew safety in dealing with sharks ahead of any other consideration and therefore shoots all that are to be landed. All sharks landed are killed and retained and the number of these is generally not likely to exceed the present limit though the incentive to reach the limit is much increased if target catches are poor, a means of keeping crew happy –at least some financial return.  
But generally the majority of sharks caught are cut free with the main objective for this to be achieved as efficiently as possible –ie little impact on hauling time and least risk to crew (from shark and or line/hook) swivel hazard. This approach is considered best to care for shark – reduced risk of damage, stress and also likelihood that if brought up 'close to vessel it will be shot and landed rather than released. Gear loss (hooks etc not a major concern but major damage ie 100-200 bite offs does significantly affect subsequent fishing effort (and more-so when /if an on-board clip carriage limit is applied as part of the strategy for managing fishing effort.)

- \*
  - Uncertainty about ultimate survival of all sharks cut free with a s/s hook and therefore questions the point of any strategy to improve survival. – points out that wire trace could be beneficial 'cos incentive would then be to recover all gear –swivel trace and hook rather than cut shark free with the hook..
  - Problem here is that as boats are allowed to and do use guns there remains a risk that all or most sharks caught would be shot first.
  - This boat never lands sharks without first shooting –a safety issue primarily (guns perhaps can be argued are a more humane and efficient way of dispatching all fish however) so there are reasons for and against their use.
  - Interesting point made re different conservation implications for the species caught –true oceanics at greater risk than those whose abundance increases or is greater over (inside) the shelf.
  - Warm side temp. front to be avoided: circle hooks better than others, blue light sticks most destructive. Method of handling means use of line cutters, de-hookers for sharks is too inefficient and of no benefit anyway.
- \*
  - 300 landed in one shot! All sharks that do not bite thru the line and come alongside are shot – safety issue and also at this point it is considered worthwhile getting all the gear back by landing the shark.
  - To land the shark requires killing it (safety and ease of handling)
  - Would freely choose to use wire and target sharks.
  - It is obvious that if wire was to be used, guns would have to go.
  - Note ratio however that 1:6 sharks stay on the line to get shot, landed and discarded dead – now issue is the point of deliberate killing to not then utilise or be free to utilize (hammerhead small are worth \$2 /kg-mako often more)
- \*
  - Not shooting routinely –usually haul up end cut free but if time permitted or if shark of manageable size would be gaffed alongside and hook removed or gaffed and landed after which it would either be killed to retrieve hook and then discarded or processed.
  - Has fished widely in AFZ and so is familiar with the change in relative abundance of species both latitudinally and longitudinally (lat. (probably temp driven, long is a consequence of proximity to continental shelf.)
  - Shark bycatch is an unavoidable nuisance, unpredictable in extent amongst target species meaning that sometimes it is necessary to persist where sharks are in high numbers (but note- new comment that it is thought that where sharks are abundant, target species(tuna) will tend to be at a greater depth. Time of day important (to avoid)
- \*
  - allowed 20/trip but never fulfill cos can't hold (no wire)
  - No gun policy onboard. Would prefer to be allowed to use wire strategically –offset bad catch periods, potentially remove a destructive individual that a) takes a lot of bait, that remains along line to destroy target catches –stock assessment issue –lost target sp. That is unaccounted for – perhaps better management to also manage the sharks.
- \*
  - guns prohibited on boats. Max value of target catch is the priority –gear loss irrelevant but time is. Water temp is important: never retain maximum permitted number of 20 per trip.
  - Operator attitude to sharks can be a consequence of where they fish mostly – well clear of the shelf or near to on the shelf.
- \*
  - One in 10 wire a useful strategy that may scare others away-total catches therefore less.
  - 20 limit per trip not a problem
  - Concentrate on the objective –tuna target –no economic sense chasing sharks-just a hassle.

The few that are landed (mako) are invariably dead as cant handle live ones safely and efficiently (too much time lost and this can result in

a) more shark damage along the line

b) higher death rate and longer time in water of target catch, the consequences of which far exceeds any revenue from sharks.

Fins alone are simply not economical in this fishery for above reasons.

Ban of using firearms in this company –big difference to shark ‘management’ on board

Seems that more offshore encounters with sharks are not so much an issue to consider as nearer shelf break.

\* (before regulations)

-wire cuts down ability to catch sharks and tuna, but it’s a necessity due to damage.

For this fishery attitude is very different whereby sharks were once (before regs) considered a very important component of commercial catch, representing 15% of income. Catching sharks was considered of equal significance to catching target species.

The regulation precluding the use of wire traces made loss of target species catch potential (bait loss) and consequential gear damage due to snake mackerel, lancet fish severe. A 38 gm swivel was incorporated into branchlines with wire but was considered to be too dangerous to crew to leave on when the branchlines were constructed entirely of mono. Seems doing this may also have increased catches of billfish, thought due to different way the bait “set” swivel wt caused bait to be ‘more lifeless?? –maybe a set depth difference.

Wire believed to reduce shark impact anyway ‘cos a high % of sharks are thought to detect the wire and be wary of it.

See little point to stringent local management when adjacent fishers have no restriction whatsoever.

## A1.12. References

- ABARE, (2003) Australian Fisheries Statistics 2003, Australian Bureau of Agriculture and Resource Economics, Canberra
- ABARE (2005), Australian Fisheries Statistics 2004, Australian Bureau of Agriculture and Resource Economics, Canberra, Australia
- AFFA, (2003), looking to the future: A Review of Commonwealth Fisheries Policy, Commonwealth Department of Agriculture, Fisheries and Forestry – Australia, Canberra
- AFMA, (1998) Logbook Validation Survey for the Eastern Tuna and Billfish Fishery, Canberra
- AFMA (2001) Southern Shark and South East Non-trawl Fishery Bycatch Action Plan (2001). Australian Fisheries Management Authority, Canberra, Australia
- AFMA, (2001), Australia’s Tuna Fisheries Bycatch Action Plan-Background Paper, Canberra
- AFMA (2004) Australia’s tuna and billfish Action Plan, Australian Fisheries Management Authority, Australian Government Canberra.
- AFMA (2005) Eastern Tuna and Billfish Fishery Management Plan 2005. Australian Fisheries Management Authority, Canberra, Australia.
- Barker, MJ and Schluessel, V. (2005 )Managing global shark fisheries: suggestions for prioritizing management strategies.
- Bigelow, K., Musyl, M.K., Poisson, F., Kleiber, P.. (2005) pelagic longline gear depth and shoaling. Fisheries Research 77, 173-183
- Bonfil, R.S. (1994). Overview of world elasmobranch fisheries. FAO Fisheries Technical Paper, 341: 119pp.
- Bureau of Resource Sciences, (2002), Fishery Status Reports 2000/01 Resource Assessment of Australian Commonwealth Fisheries, Agriculture, Fisheries and Forestry – Australia, Canberra
- Bureau of Resource Sciences, (2003) Fishery Status Report 2002, Agriculture, Fisheries and Forestry – Australia, Canberra
- Commonwealth of Australia (1998) Australia’s Oceans Policy, Canberra, Australia

- Commonwealth of Australia (2000), Commonwealth Policy and Fisheries Bycatch, Australian Fisheries Bycatch, Australian Fisheries Management Authority, Environment Australia and the Department of Agriculture, Fisheries and Forestry – Australia, Canberra
- Daley, R., Stevens, J., Last, P and Yearsley, G.(2005) Field Guide to Australian Sharks and Rays, CSIRO, Hobart.
- Dambacher, J.M.(2005) Analysis of AFMA observer data July 2004 to June 2005. Eastern Tuna and Billfish Fishery Resource Assessment Group Meeting November 17-18 2005. CSIRO Marine and Atmospheric Research Lab. Hobart, Tasmania.
- Department of Environment and Heritage (DEH) (2005) Draft Threat Abatement Plan 2005 for the incidental catch (or bycatch) of seabirds during oceanic longline fishing operations DEH, Kingston, Tasmania, Australia
- Environment Australia, (2000a) Recovery plan for Grey Nurse Sharks, *carcharias taurus*, in Australia, Environment Australia, Canberra
- Environment Australia (2000) Commonwealth Policy on Fisheries Bycatch
- Environment Australia, (2000b) white shark (*carcharodon carcharias*) Recovery plan, Environment Australia, Canberra
- FAO (1999) The international plan of action for the conservation and management of sharks. FAO. Rome.
- Falterman, B., and Graves, J.E. (2002) A comparison of the relative mortality and hooking efficiency of circle and straight shank (“J”) hooks used in the pelagic longline industry. *Amer. Fish. Soc. Symp.* 30: 80-87
- Francis M. P., Griggs, L.H., and Baird, S.J., (2001) Pelagic shark bycatch in the New Zealand tuna longline fishery. *Mar. Freshwater Res* 52 165-78
- Graham, K.J., Andrew, N.L., and Hodgson, K.E. (2001) Changes in relative abundance of sharks and rays on Australian South East Fishery Trawl grounds after twenty years of fishing. *Mar. Freshwater Res* 52, 549-61.
- Harris, A and Ward, P. (1999) Non-target species in Australia’s Commonwealth Fisheries. A Critical Review, Bureau of Resource Sciences, Canberra
- Hobday, A., Stobutzki, I., and Webb, H. (2004) Draft ecological Risk Assessment of Effects of fishing: Eastern Tuna and Billfish Fishery (V7). In Hobday, A., Smith, A.D.M., and Stobutzki, I. Ecological Risk Assessment for Australian Commonwealth Fisheries. Final Report-Stage 1. Hazard identification and preliminary risk assessment. Report to the Australian Fisheries Management Authority, Canberra, Australia
- Jusseit, H. and Robinson, E. (2003) Eastern Tuna and Billfish Fishery: Industry Code of Practice for Responsible Fishing. East Coast Tuna Boat Owners Association Inc.
- Kaibla, PJ, Williams MJ, Stewart PC, Reichelt RE, Mc Nee A and Grieve C.(1993) Australian Fisheries Resources. Bureau of resource sciences, Dept of Primary Industries and the Fisheries Research and Development Corporation Canberra
- Last, P.R., and Stevens, J.D., (1994) Sharks and Rays of Australia, CSIRO Division of Fisheries, CSIRO Division of Fisheries, CSIRO, Australia
- Ministerial Council on Forestry, Fisheries and Agriculture (MCFFA) (1999). National Policy on Fisheries Bycatch, FAFF, Canberra, Australia
- Moyes, C.D., Fragoso, N. Musyl, M.K. Brill, R.W. (2006) Predicting post-release survival in large pelagic fish. Accepted into Transactions of the American Fisheries Society.
- Oritz, E. and Pease, B., (1992), Validation of Commonwealth Logbook Data for the NSW Component of the East Coast Tuna Fishery, NSW Fisheries Research Institute, Cronulla
- Rey, J.C and Munoz-Chapuli, R (1991) Relation between hook depth and fishing efficiency in surface longline gear. *Fishery bulletin* (1991). 89: 729-732.
- Rose, C and SAG (2001). Australian shark assessment report for the national plan of action for the conservation and management of sharks, Canberra,
- Rose, C., and McLaughlin, K. (2001) Review of shark finning in Australian fisheries, Bureau of Rural Sciences, Canberra, Australia
- SCFA (standing committee on fisheries and Aquaculture) (1998) Research priorities for Australian fisheries and aquaculture, SCFA, Canberra.
- Shark Advisory group and Lack, M (2004) National Plan of Action for the Commonwealth and Management of Sharks Australian Government Department of Agriculture, Fisheries and Forestry. Canberra ACT 2601.



- Shotton, R. (Ed.) (1999). Case studies of the Management of elasmobranch fisheries. FAO Fisheries Technical Paper. No 378. 920 pp. (FAO: Rome.)
- Stevens, J. and Wayte, S. (1998) A review of Australia's pelagic shark resources. FRDC project 98/107.
- Stevens, J.D. (1999) Management of Shark Fisheries in Northern Australia. In Shotton R 1999 (Ed). Case studies of the management of elasmobranch fisheries. FAO Fisheries Technical Paper 378/1&2, 456-479 pp United Nations Food and Agricultural Organisation, Rome.
- Stevens, J.D.,(1999) Management of Shark Fisheries in Northern Australia. In case studies of the management of elasmobranch fisheries. (Shotton, R. 1999 Ed)
- Stevens, J.D. (1992) Blue and mako shark bycatch in the Japanese longline fishery off south-eastern Australia. In: Sharks : Biology and fisheries, pp 227-36 Ed. J.G. pepperell. Australian Journal of Marine and Freshwater Research, 43: 349 pp.
- United nations, (1995), Agreement for the Implementation of the Provisions of the United Nations Convention on the Law of the Sea of 10 December 1982 Relating to the Conservation and Management of Straddling Fish stocks and Highly Migratory Fish Stocks, United Nations.
- Ward, P.J. (Ed.) (1996), Japanese Longlining in Eastern Australian Waters 1962-1990 Bureau of Resource Sciences, Canberra
- Ward, P., Robbins, C., Kreutz, D (2005) The effect of circle hooks on target and non-target catches in Australia's longline fisheries. Bureau of Rural Sciences, Canberra, Australia
- Watson, J.W., Epperly, S.P., Shah, A.K. and Foster, D.G. (2005) Fishing methods to reduce sea turtle mortality associated with pelagic longlines. Canadian Journal of Fisheries and Aquatic Sciences 62: 965-981

## Appendix 2

### Chile Artisanal Mahimahi and Shark Longline Fishery and Longline Swordfish Fishery: Industry Practices and Attitudes towards Shark Depredation and Bycatch

Joanna Alfaro-Shigueto and Jeff Mangel, Pro Delphinus, Peru,  
prodelphinus@prodelphinus.org

Miguel Donoso, Instituto de Fomento Pesquero, Chile, mdonoso@ifop.cl

Twenty-two interviews with artisanal longliners for mahi mahi and industrial swordfish fishermen were conducted in three fishing ports in Chile from February to August 2006 (three from the swordfish fishery and 19 from the artisanal mahi mahi longline fleet). Of the artisanal fishermen, 2 were vessel owners, 10 were captains and 7 were crewmembers. Average years of fishing were 37.5 for owners, 20 for captains and 18.5 for crew members. All three swordfish fishermen interviewed were captains with an average of 11 years fishing.

Information on the longline fishery was obtained from the publications of the Servicio Nacional de Pesca (SERNAPESCA), the Instituto de Fomento Pesquero (IFOP) and from the Food and Agricultural Organization (FAO) publications that make reference to Chilean fisheries and the FAO Fish Stats program. Information on the regulations was obtained from the Subsecretaría de Pesca (SUBPESCA).

Chile is divided in 12 geographic and political regions (I-XII). To promote decentralization, each of these Regions has regulations and quotas for each fishery. In northern Chile the artisanal longline has a shark fishery similar to the Peruvian shark fisheries. For the purpose of this study we conducted the surveys in this area during the mahi mahi season, where sharks are taken as bycatch, and also conducted the surveys of the industrial swordfish fishery, where sharks are also taken as bycatch.

#### A2.1. Artisanal Longline Fishery Characteristics

Chilean legislation defines the artisanal fishery as an operation run by individuals (fisherman, captain, vessel owner or crew) or industries registered as such and using an artisanal vessel. An artisanal vessel should be registered in that category, and has a maximum length of 18 meters and a maximum weight of 50 tons (Ley General de Pesca y Acuicultura, 1991).

There are about 131 vessels registered for this fishery (Barria *et al.*, 2006). The artisanal fishery for mahi mahi (*Coryphaena hippurus*) operates during the austral summer and for sharks throughout the year. There are slight variations in fishing methods from vessel to vessel in the artisanal longline fleet.

The use of longlines by the artisanal fleet to target sharks is only authorized by the government to occur along Chile's northern coast from Region I to Region III (Diario Oficial, 2002). The main ports in these Regions are Arica, Iquique, Tocopilla, Antofagasta and Caldera (Barria *et al.*, 2006). Sharks may be taken throughout the year, but during certain seasons, when mahi mahi is more available and has a higher value, the fleet tends to target mahi mahi. During the mahi mahi season, vessels only land sharks that are caught during the trips last sets and only if space is available on the vessel. If availability of sharks is good, blue sharks are usually discarded because the price for mako sharks is higher.

Captures of mahi mahi in these three regions account for 70% of total landings of the species for the country. Forty seven percent of the country total is captured in Region I (Arica and Iquique ports) (SERNAPESCA, 2006).

## A2.2. The Industrial and Artisanal Swordfish Fishery

The industrial swordfish fishery's main target is the swordfish (*Xiphius gladius*), but other species are also captured and retained (Fig. A2.1). This fishery includes 16 longline vessels operated from Coquimbo and Valparaiso (for administrative purposes, ten of these vessels are registered as industrial while the remain 6 are listed as artisanal). This is a seasonal fishery that operates mainly from March to December. Length of vessels range from 16.6- 42.2 m. Storage capacity ranges between 40 to 374 m<sup>3</sup> (Barria *et al.*, 2006).

This longline fishery operates mainly from 16°S - 40°S and 78°W - 108°W. The fleet is active primarily from March to September, but some sets are also performed through December. The principal fishing areas are in front of Valparaiso and Concepcion at 80°W (Barria *et al.*, 2006).

The fishery has been monitored by IFOP since 2001 through the collection of information from shore based and onboard observers. During 2005 the onboard observer program covered 74% of the industrial vessels (Barria *et al.*, 2006).

Fig. A2.1. Bycatch species in the Chilean industrial longline swordfish fishery, 2005 (Barria *et al.*, 2006).

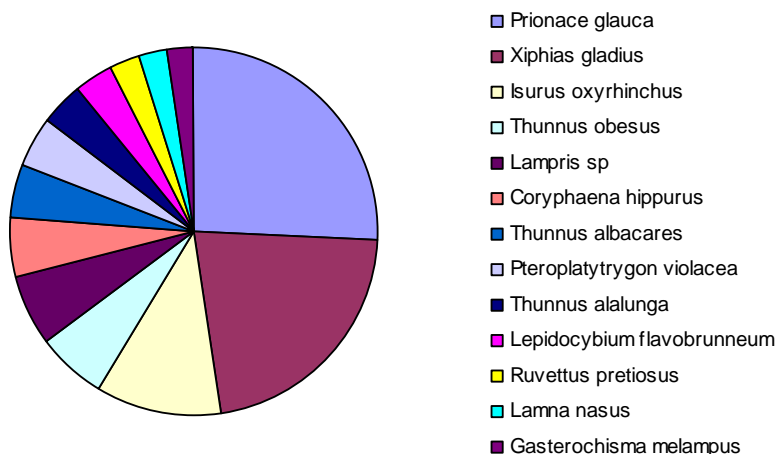

## A2.3. The Elasmobranch Fishery

The Chondrichthyans fishery has become an important resource for developing countries. Its role increased in terms of food and income generation due to the increasing demand for shark fins, the increase in human population, and the decline in landings of traditional species. Developing countries' catches increased from 76,000 metric tons (MT) in 1950 to 575,031 MT in 2000 for a value in the year 2000 of \$515 million (Cattarci, 2004; FAO, 2006)<sup>1</sup>.

Chile has a fishery targeting chondrichthyans. This fishery has increased significantly over the last few decades. Table A2.1 and Fig. A2.2 show the production of elasmobranchs in Chile for the past several decades.

<sup>1</sup> All prices are given in U.S. dollars unless otherwise indicated.

Table A2.1. Catch of the main shark species in Chile, 1991-1996 (SERNAPESCA, 2006; Vanuccini, 1999).

Species	1991	1992	1993	1994	1995	1996
Rays	1,171	1,239	1,971	2,899	2,622	2,679
Makos	1,118	702	581	450	475	320
Smoothhounds	937	481	398	588	193	225
Blues	212	175	237	33	39	11
Total	3,438	2,597	3,187	3,970	3,329	3,235

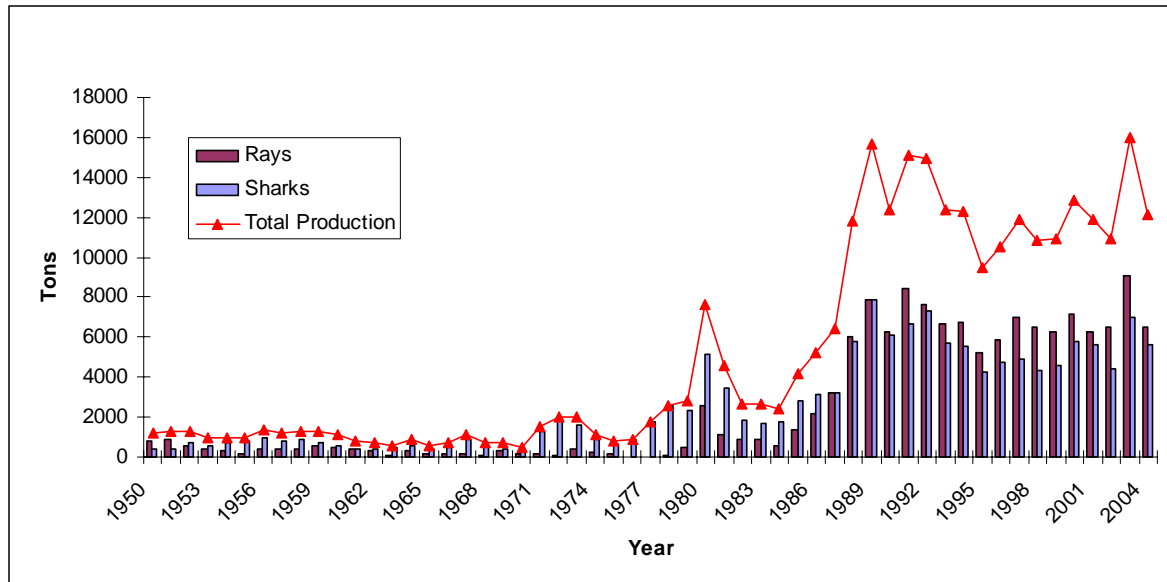

Fig. A2.2. Total elasmobranch production in Chile, by species groups, 1950-2004 (FAO, 2006).

The species of chondrichthyans captured for commercial ends in Chile include primarily makos (*Isurus oxyrinchus*), blues (*Prionace glauca*), smoothhounds (*Mustelus* sp.), yellownose skates (*Dipturus chilensis*), *D. trachyderma*, and a holocephali (chimera) known as “pejegallo” (*Callorhynchus callorhynchus*) (Sernapesca, 2006). Fig. A2.3 shows the catches of these species of chondrichthyans in Chile from 1990 to 2005 (SERNAPESCA, 2006).

For this study we conducted interviews of artisanal longliners in Chile’s northern regions. These vessels target mahi mahi and sharks primarily during the summer months. We also surveyed the industrial swordfish longline fishery where sharks are captured as bycatch.

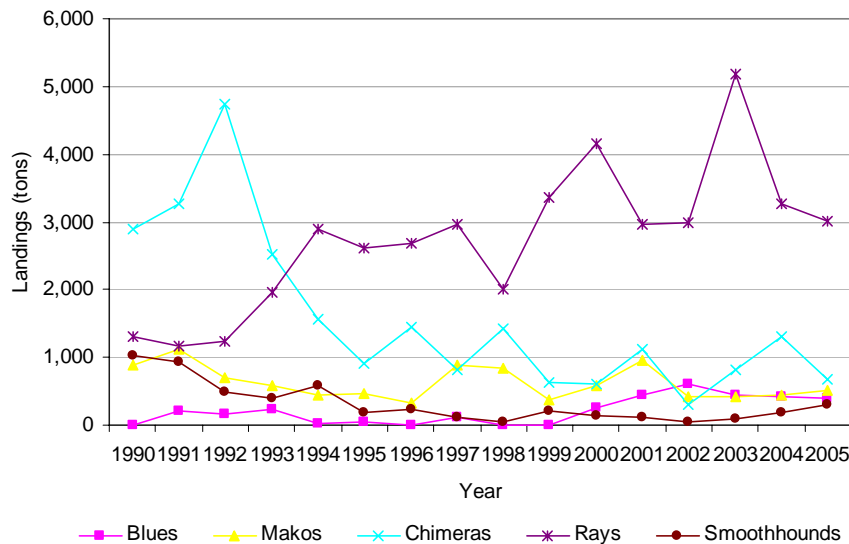

Fig. A2.3. Catch of chondrichthyans in Chile, 1990 - 2005 (SERNAPESCA, 2006).

## A2.4. Range of Fishing Gear and Methods

### A2.4.1. Artisanal mahi mahi longline

This fishery operates in Arica, Iquique, Tocopilla, Antofagasta and Caldera (Barria et al., 2006). Vessels are between 9.1 and 13 meters total length (Barria et al., 2006). They typically work with a surface horizontal longline. Mainline length varies slightly by boat from 2,700 to 3,600 meters. Number of hooks also varies but is typically about 100-350. Mahi mahi season is from December to March. Trip length varies by season with mahi mahi trips typically lasting 3 to 4 days. Almost all vessels use J hooks. Bait species include sardine, mackerel and flying fish (Barria et al., 2006). Total boat crew generally consists of 2 to 3 persons. Gear is set around 7:00 AM and hauled at 4:00 or 5:00 PM (Barria et al. 2006 and present surveys). Weighted swivels and steel leaders are used during the shark season. Table A2.2 provides a comparison of artisanal mahi mahi gear with industrial longline swordfish gear.

### A2.4.2. Industrial swordfish fishery

This fishery mainly uses the American longline configuration (12 of 16 vessels) but several vessels use the Spanish configuration. The following information on gear characterization for both configurations was taken from Barria *et al.* (2006). See Table A2.2 and Figs. A2.4 and A2.5 for a comparison of longline gear configurations.

The Spanish configuration includes a mainline of braided polypropylene rope. The mainline is divided into 110 hooks sections. Each of these sections has a radio beacon buoy at its beginning and end. Every 23 fathoms there is a branchline with a hook, and each branchline is knotted to the mainline. A buoy is placed every 10 branchlines. Branchlines are 4.5 fathoms long. Leaders are made of polypropylene but also has a portion made of metal cable (1.5 mm diameter). This cable adds weight to the line and is better able to retain sharks. Vessels usually deploy a 45 nautical mile long mainline containing approximately 2,000 hooks. The Spanish system does not allow for variation in the depth of the hooks.

These vessels also use photoactive plastic polymer balls that glow after being exposed to light. Each hook has four of these. Spanish and Chilean mackerel and squid (*Illex argentinus*) are used for bait.

The American configuration has a monofilament mainline. In this system the mainline is divided into sections of 220-250 hooks with a radio beacon buoy at the beginning and end. The mainline usually has

a total of 7 beacon buoys and 1500 (range of 1200-2000) hooks. Distance between hooks and depth of hooks can be modified. Every 5 hooks there is a float buoy. As the distance between hooks is increased, the maximum depth of the hooks increases as does the total mainline length. Mainline length ranges from 35 to 55 nautical miles.

The American configuration uses lights in the weighted swivel (65-75g.). These may be chemical or battery powered. Light are green or violet. Branchlines may be 6 to 18 meters long and have a 15-20 cm cable leader. This system uses a timer for setting of hooks (8 to 16 seconds). Bait used is squid and Chilean mackerel. Bait is usually hooked through the eye but may also be hooked in the back or tail. The American configuration generally operates more cleanly (less bycatch) than the Spanish system.

Table A2.2 and Fig. A2.4 and A2.5 summarize the general fishing methods and gear deployment strategies for the longline for mahi mahi and swordfish in the ports where surveys were conducted. It should be noted, however, that fishing methods and gear deployment vary somewhat from port to port and vessel to vessel.

Table A2.2. Fishing gear characteristics of the Chilean longline fishery (from surveys and Barria et al., 2006).

Gear Characteristic	Artisanal Mahi Mahi	Industrial swordfish	
		Spanish System	American System
Mainline material	Multifilament 4-5mm Ø	Polypropylene Multifilament 6mm Ø	Monofilament 3.5mm Ø
Mainline length	1500-2000 fathoms (2.7–3.7 km)	45 nautical miles (83 km)	35-55 nautical miles (64-101 km)
Mainline deployment	Superficial	Mid-water	Mid-water
Distance between buoys	18-36 m (10-20 fm)	4.5 km	varies
Distance from buoy to mainline (float line length)	NA	10 fathoms	10 fathoms
Average branch line length	9.1 m (5 fm)	8.2 m (4.5 fm)	16.5 m (9 fm)
Branch line material	Monofilament	polypropylene	Monofilament 20mm Ø
Wire trace or leader on branch lines	Sometimes	Yes or no	Yes
Number of hooks between buoys	1	110	220-250
Average maximum depth of hooks when set	6-8 fathoms	70m	70m
Average maximum depth of mainline when set	Superficial	50m	50m
Mainline sink rate	No information	No information	90 m in 16 seconds
Timing of set, soak, and haul	Set: 7 AM (for 2-6 h) Soak: surveying the line several times a day Haul: 4 to 5 PM (for 3- 4 h)	Set: 6-8 PM (for 4 h) Soak: 20h Haul: 8AM (for 8 h)	Set: 6PM (for 4 h) Soak: 8h Haul: 8AM (for 6 h)
Lightstick use	No	Plastic polymer	chemical or battery
Number of hooks per set	100-350	1500	1200-2000
Hook setting interval	No information	No information	8-16 seconds
Radio beacons	No	Yes	Yes
Hook type	J 0,1,2,3 (10° offset)	J17 Ancora (no offset) J18 Ancora (no offset or 10° offset)	J Mustad 9 (10° offset)
Weight size and location	NA	60 g. at connection of mainline with float line	80 g. at connection of mainline with float line 65-75 g. swivel at top of leader
Clip size and type	NA	350S	350S
Bait type	Mackerel and sardine	Squid or mackerel	Squid and mackerel
Number of crew	2-3	12-15	8-10
Vessel Monitoring System	No	No	No

### Palangre Español

#### Vista general

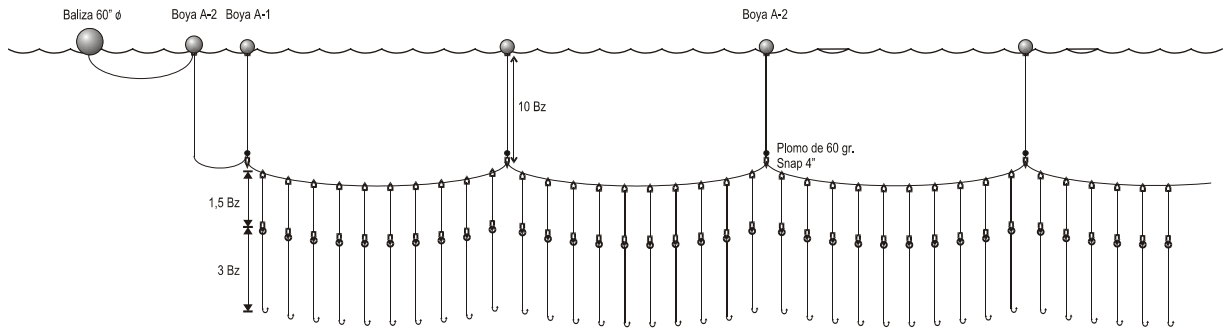

#### Vista parcial

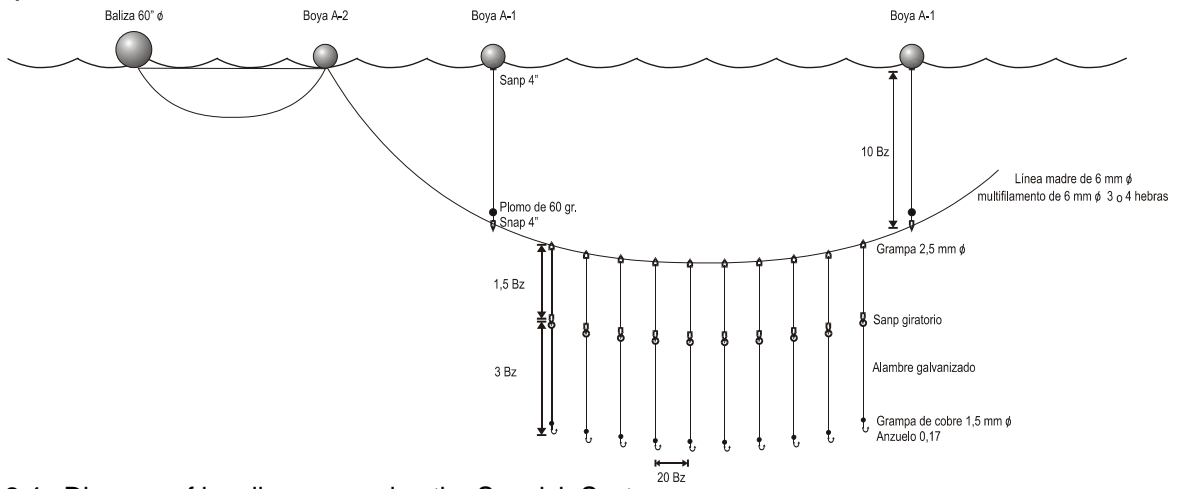
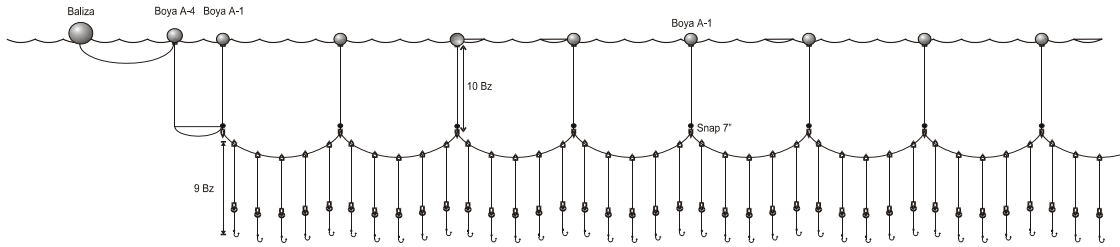

Fig. A2.4. Diagram of longline gear using the Spanish System.



### Palangre Americano

#### Vista general



#### Vista parcial

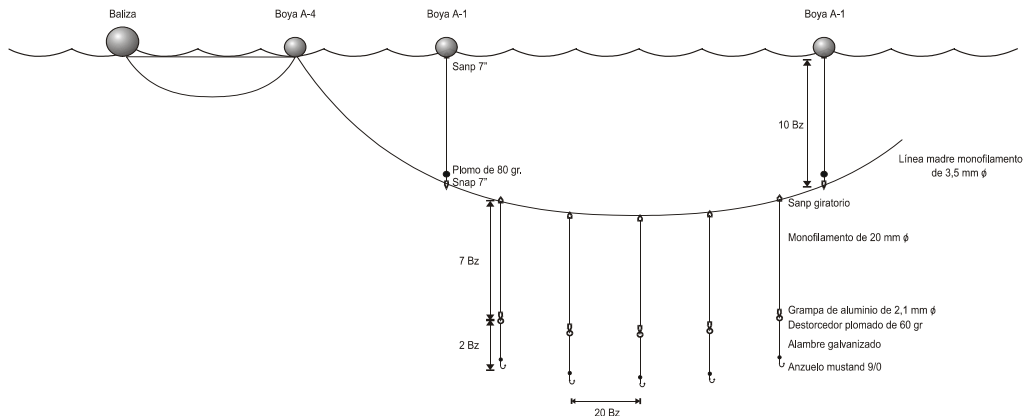

Fig. A2.5. Diagram of longline gear using the American System.

### A2.5. Catch and Discard Rates of Target and Bycatch Species

A summary of shark yield for the artisanal longline shark fishery from 2003-2005 is presented in Table A2.3.

Table 3. Catch per unit effort of sharks of the artisanal shark fleet, 2003-2005 (Barria *et al.*, 2006).

Month	Yield (g/hook)								
	2003			2004			2005		
	Mako	Blue	Total	Mako	Blue	Total	Mako	Blue	Total
Jan	194.3	22.7	217.0	245.6	8.5	254.1	314.6	9.5	324.1
Feb	265.2	22.5	287.7	401.3	9.1	410.5	301.8	8.1	309.9
Mar	382.2	47.8	430.0	236.5	17.3	253.8	269.1	55.8	325.0
Apr	281.3	58.8	340.1	290.6	38.9	329.5	232.6	69.1	301.7
May	154.2	28.1	182.3	249.4	35.0	284.4	261.8	85.9	347.7
Jun	160.3	57.1	217.5	168.7	31.7	200.4	85.4	68.8	154.2
Jul	27.5	11.7	39.3	78.9	82.6	161.4	74.2	37.0	111.3
Aug	52.9	29.6	82.4	75.6	97.5	173.1	91.1	55.8	146.9
Sep	141.5	50.6	192.1	119.0	62.2	181.2	45.8	119.1	164.9
Oct	172.7	78.1	250.8	183.9	49.5	233.5	58.9	147.6	206.5
Nov	188.6	37.5	226.2	283.5	40.8	324.3	295.5	71.9	367.5
Dec	208.9	15.5	224.3	224.0	14.1	238.1	160.4	25.6	186.0
Total	216.9	37.5	254.4	249.8	26.9	276.7	235.9	41.8	277.7

A summary of swordfish captures, effort and yield for the industrial and artisanal swordfish fleets during 2004 and 2005 is presented in Table A2.4.

Table A2.4. Swordfish capture, effort and yield of the industrial and artisanal swordfish fleet (Barria et al., 2006).

Month	Capture (kg)		Effort (# hooks)		Yield (g/hook)	
	2004	2005	2004	2005	2004	2005
Jan		793		980		809
Feb		12838		20998		611
Mar		63599		138740		458
Apr	88164	147611	247890	234352	356	630
May	143354	147522	325025	324981	441	454
Jun	74609	136215	206336	253424	362	537
Jul	128120	207226	280805	365073	456	568
Aug	94786	158662	354098	359530	268	441
Sep	126771	132303	351787	330693	360	400
Oct	60926	148784	240473	239527	253	621
Nov	75683	109411	171665	234675	441	466
Dec	94873	47082	291911	174808	325	269
Total	887287	1312046	2469990	2677781	359	490
% variation		47.9		8.4		36.4

During the 2005 season of the industrial swordfish fishery, almost all sharks captured were retained and commercialized (Table A2.5). Total fleet effort for 2005 consisted of 2.16 million hooks.

Table A2.5. Catch, revenue and CPUE of swordfish and sharks for the industrial swordfish fishery, 2005 (Barria et al., 2006).

Species	Catch (kg)	Revenue (\$1000US)	CPUE (kg/hook)
Swordfish	2,193,129	11404.3	1.01
Blue sharks	535,721	482.1	0.25
Mako sharks	247,662	598.1	0.11

## A2.6. Regulations and Management Framework

Fisheries regulations are formulated by the Fisheries Sub Secretary (SUBPESCA). Implementation and monitoring of regulations is conducted by SERNAPESCA.

Ley General de Pesca y Acuicultura (1991) established a number of regulations for industrial and artisanal fisheries. The most important of these is the proportional distribution of total captures to industrial vessel owners (a maximum capture limit per owner).

SUBPESCA has also established maximum quotas by fishing season and by Regions and has suspended new authorizations of industrial vessels.

Chile has a National Plan of Action for Sharks that addresses most of these regulations and promote the establishment of other, new regulations. These proposed regulations would address issues such as bycatch monitoring and assessment (SERNAPESCA, 2006a).

## A2.7. Shark Market and Management Framework

There has been a substantial increase in longline vessel operations in Chile from 1986 to 1995 (Fig. A2.6).

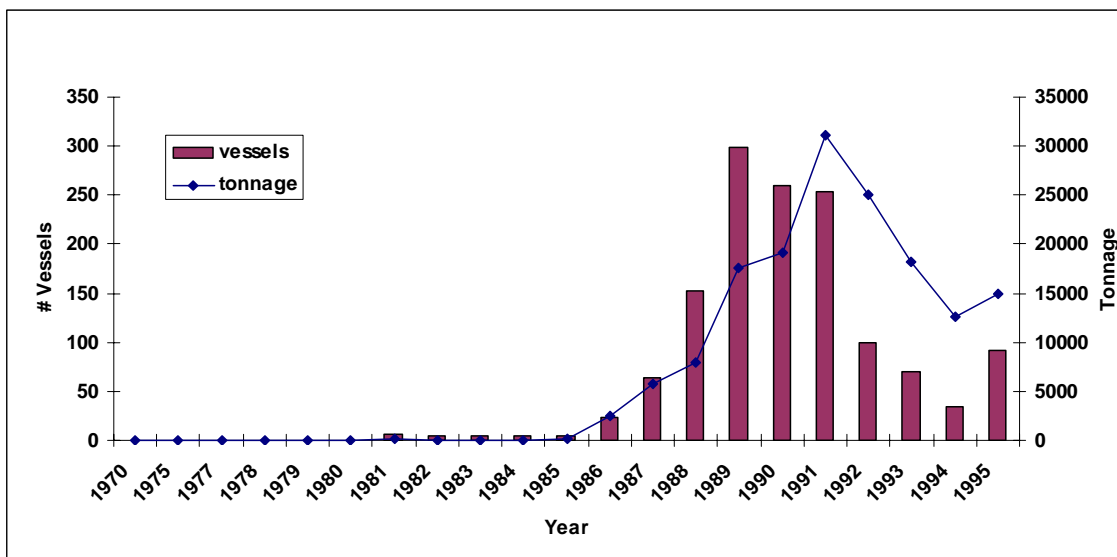

Fig. A2.6. Growth of the longline fleet in Chilean waters from 1970 to 1995 (FAO, 2006).

During this same period, growth in shark exports was much more variable (Fig. A2.7).

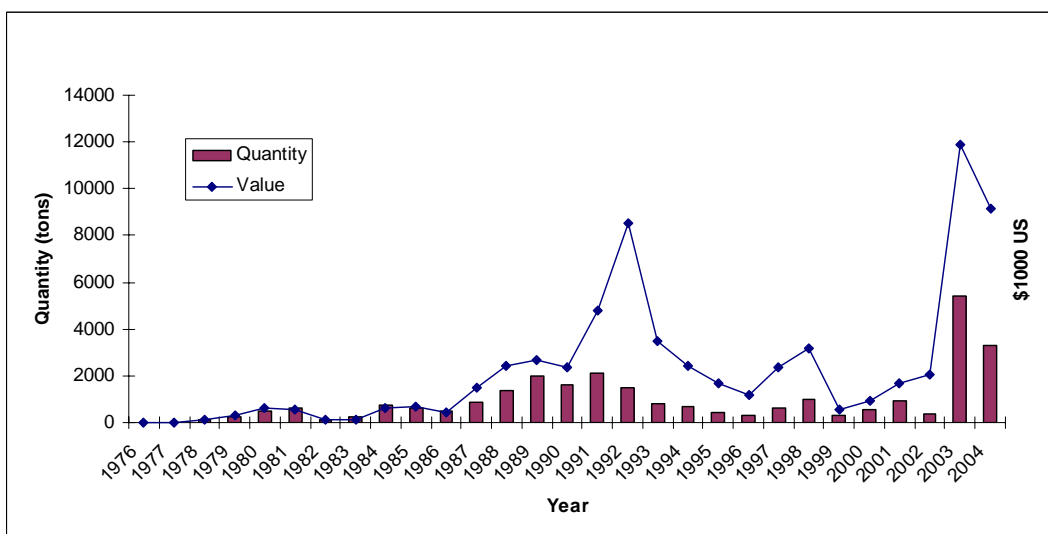

Fig. A2.7. Total shark exports in quantity and value, 1976-2005 (FAO, 2006).

Fresh shark products are directed mainly to the domestic market, while fins are exported (Vanuccini, 1999). Captured skates are destined almost entirely for export to Asian markets (Acuña and Lamilla, 2004). Skate wings are exported frozen. Shark species such as blues, makos and smoothhounds are mainly exported as frozen headed-and-gutted and as steaks. Fins are exported dried (Vanuccini, 1999; Table A2.6).

Table A2.6. Exports of shark and ray products from 1993 to 1997 (Vanuccini, 1999).

Species	1993		1994		1995		1996		1997 (Jan-Nov)	
	\$	Tons	\$	Tons	\$	Tons	\$	Tons	\$	Tons
Rays	2,136	1,420	4,343	2,371	5,420	2,948	4,494	2,278	4,347	1,954
Makos	804	240	696	268	1,011	199	634	121	1,147	159
Blues	254	42	581	136	162	20	215	41	69	27
Smoothhounds	29	16	23	10	57	27	33	15	--	--
Shark (unspecified)	332	42	371	61	358	65	456	46	544	38
<b>Total</b>	<b>3,555</b>	<b>1,760</b>	<b>6,014</b>	<b>2,846</b>	<b>7,008</b>	<b>3,259</b>	<b>5,832</b>	<b>2,501</b>	<b>6,107</b>	<b>2,178</b>

Prices are variable and there are large differences between dried shark fin and chilled and frozen products (Table A2.7).

Table A2.7. Average FOB prices for chondrichthyan products during the last six years (Vanuccini, 1999).

Species	Product	\$/Ton	Destination
Mako	Frozen	1,867	Spain
		1,886	Italy
		2,364	USA
	Chilled	2,661	USA
Shark – unspecified	Frozen	37,095	Far East
		2,567	Germany
		2,708	Spain
	Chilled	2,255	USA
Blue	Frozen	37,731	Far East
		792	Netherlands
		541	Germany
	1,300	Spain	
Smoothhound	Frozen	35,062	Asia
		2,785	New Zealand
		1,329	France
	1,065	Spain	
Ray	Frozen wings	1,913	Republic of Korea
		1,856	France
		1 398	Spain

## A2.8. Economic, Social, and Ecological Effects, Including Effects on Fishing Practices, from Regulations Governing Shark Interactions

From the twenty-two fishermen interviewed, 7 were based in Arica, 12 in Iquique and 3 in Valparaíso. Almost all (95.5%) interviewed fishermen report that they always retain sharks during the mahi mahi and swordfish season. Regularly, blue and mako sharks are caught and the whole body and fins are retained. However, sometimes blue sharks are only finned and the bodies are discarded. The whole crew and boat owner receive the revenue from the sale of fins and meat. Meat of blue sharks is sold for approximately \$0.3-1.5 and makos for \$1.5-3.8 per kilo. Revenue from fins ranges up to \$7.4 per kilo. Mako fins are more valued than those of blue sharks.

Almost two thirds (64%) of respondents replied that income from sharks has not changed throughout the years. Two of three swordfish fishermen replied that in the past, revenue from fins was retained by the vessel owner only and one replied that revenue from the sale of sharks is retained by the owner company.

Revenue from the sale of cartilage, jaws or liver oil is retained by the whole crew and boat owner.

Almost half (47.4%) of mahi mahi fishermen mentioned that there are no regulations for sharks in their country, and more than half (52.6%) mentioned that in the event that such regulations existed, they have not affected the way they deal with sharks. All swordfish fishermen reported that they were not aware of any regulations concerning sharks.

For most of the fishermen interviewed (95.5%), revenue from catching sharks exceeded the cost from shark depredation and loss and damage to gear (average damage cost per mahi mahi set was \$18.5, per swordfish set it was 50-100 hooks and/or branch lines). Only one swordfish fisherman (4.5%) mentioned that revenue from sharks does not exceed the cost of shark depredation and damage to gear.

Most fishermen change their fishing methods and gear during the mahi mahi season. These changes - such as using nylon monofilament, using giant squids for bait, setting hooks shallower than in shark season, and fishing in areas closer to shore - have the indirect effect of reducing shark captures. The effect is unintentional

because the main objective of the changes to fishing methods and gear is to increase mahi mahi captures, not necessarily to reduce the capture of sharks. However, some mahi mahi fishermen indicated they would use wire leaders to avoid gear loss. Wire leaders were said to be as effective as nylon monofilament on branch lines. Fishing for mahi mahi during summer is more profitable because fishing areas are closer to shore and the amounts of mahi mahi are considerably higher than during the shark season.

## **A2.9. Practices to Deal with Caught Sharks and Costs from Shark Depredation and Gear Damage**

32% of mahi mahi longline vessels use a nylon monofilament at the end of the branch lines, located between the baited hook and a weighted or un weighted swivel. Another 42% use only wire leaders at the end of the branch lines, while 21% use a mix of wire leaders and nylon monofilament. Wire leaders are mentioned as used to avoid shark damage or loss to gear. Fishermen do not believe use of wire leaders reduces target species capture.

Two of three swordfish vessel respondents reported using wire leaders at the end of the branch lines. One of the three respondents reported using nylon monofilament.

Almost two thirds (63.8%) of respondents reported that sharks that bite baited hooks in mahi mahi gear bite through the monofilament line and are not retained on the line to be hauled to the vessel. From this study (19 interviews), respondents noted that vessels catch an average of 5.3 sharks on a typical mahi mahi set. The three respondents from swordfish vessels indicated that they catch an average of 13.1 sharks on a typical set and only 6.7% of sharks bite through the monofilament line.

Most (95.5) respondents, both mahi mahi and swordfish fishermen, will always retain sharks that get caught in the fishing gear. However, almost three quarters (72.2%) of mahi mahi fishermen did report discarding the carcasses of some sharks. Discard sometimes occurs when catching blue sharks (in which case they retain the fins only) or when sharks are small (in which case they are released alive).

One of the swordfish fishermen reported retaining mako sharks only and not blues.

Two mahi mahi fishermen report that for about 15% of caught sharks, the crew cut the branch lines. One of these fishermen mentioned that he would only do that if a big blue shark was caught and hook has been swallowed. Responses among swordfish fishermen varied. One mentioned that the crew cut the branchlines for 90% of caught sharks. The other two replied they would cut the branch line only for about 5-10% of caught sharks. These fishermen also mentioned that they cut the branch lines either close to the hook or up to 2 fathoms from it. The main reason given by one swordfish fisherman for cutting branchlines was that when hauling process has to be done fast they could not spend time handling sharks.

Two mahi mahi fishermen described ways of de hooking sharks using a knife or a pair of pliers. One swordfish fisherman reported that he uses a wooden stick to retrieve hooks but only with small sharks.

More than two thirds (68.4%) of mahi mahi fishermen report that sharks will either break the main line or bite through the nylon monofilament in the branch line thus losing hooks. Two of three swordfish fishermen responded similarly. The average cost reported from damage and loss of gear due to sharks was \$18.5 for a typical mahi mahi set.

Fishermen reported having an average of 5.5 mahi mahi fish and 3.3 swordfish damaged from shark bites on a typical longline set for artisanal and industrial vessels, respectively. This represents a loss of approximately \$146 per mahi mahi set and \$1063 per swordfish set, depending on the size of the fish that are damaged.

Only 37% of mahi mahi fishermen considered shark interactions to be problematic. Among those, more than a half (57%) reported that shark interactions are a problem more because of the amount of time they have to spend repairing and replacing lost gear versus 14.3% who report the cost of lost and damaged gear as the main reason shark interactions are a problem. Another 29% of respondents replied that shark damage is a problem because of both the time and cost of repairs. About half (47.4%) of respondents reported that neither time nor cost resulting from shark interactions was problematic.

Two of three swordfish fishermen reported that shark interactions were not problematic. One reason for this response was that loss of gear and damage by sharks is considered part of their work. Only one fisherman replied that shark damage is a problem because of both the time and cost of repairs.

Most (84.2%) interviewed mahi mahi fishermen would not avoid catching sharks if they could. The most cited reasons for this were that sharks mean extra revenue because of their meat and high value fins, and that there is nothing to be done to avoid catching sharks since they use wire leaders. Only 15.8% of respondents stated that they would avoid catching sharks because fishing for mahi mahi is more profitable during summer.

For swordfish respondents, two replied that they would avoid catching sharks if they could because sharks are not well valued or for purposes of shark conservation. Only one fisherman stated that he would not avoid catching sharks unless there were regulations prohibiting it.

## **A2.10. Methods for Onboard Processing of Retained Sharks**

In the mahi mahi fishery, sharks that will be retained and landed are usually finned. Animals are brought on board where they are immobilized by hitting them in the head with a wooden stick and then cutting the head (48% of respondents). Only one respondent (4%) stated that he immobilizes sharks by cutting off the tip of the snout and passing a metal wire into the brain. Also, two fishermen (8%) mentioned the use of a de hooker for hooks removal. After immobilization the animal is gutted (sometimes at the completion of the haul - 12% of respondents) and is put on ice with the rest of the catch.

Swordfish fishermen indicated that they process sharks in a similar way. Two of three respondents indicated that sharks were finned before being placed on ice.

## **A2.11. Reasons for Discarding Sharks**

There are no minimum capture size regulations for sharks in Chile. As a result, most respondents (95.5%) indicated that they do not discard any sharks once they are hooked. However, most mahi mahi fishermen (72%) reported discarding sharks for the following reasons: (1) when catching blue sharks they retain fins only (44% respondents), (2) when sharks are small (22% respondents), and (3) when there is chance sharks would contaminate the catch of mahi mahi (6% respondents).

Swordfish fishermen, on the other hand, report storage capacity (50%) as one of the main reasons for discarding sharks. One quarter (25%) of respondents mentioned that they retain mako sharks only.

Shark meat and fins are marketable for blues and makos and prices are generally equal to or higher than that of the target species mahi mahi. This high value for incidental shark take means that fishers will not discard incidentally captured sharks. For swordfish fishermen, revenue from shark fins is considered a significant source of extra income that almost equals their income from swordfish.

## **A2.12. Practices Employed to Reduce Shark Capture and Depredation**

Some mahi mahi fishermen (36.8%) identified several strategies to reduce shark capture and depredation. Strategies mentioned were varied - from establishing regulations and bans to using rotten bait. The other 57.9% mentioned that there is not much that can be done to reduce shark capture or depredation since sharks are found everywhere. However, fishermen employ strategies to increase mahi mahi capture which indirectly reduce shark capture. The most commonly identified practice to avoid shark interactions is by changing fishing position. During mahi mahi season fishing areas are closer to shore than those areas fished during shark season. Only 26.3% of fishermen interviewed indicated that they would change fishing position in order to reduce gear loss if the catch of sharks was especially high and because they are more interested in fishing for mahi mahi. Almost three quarters (73.7%) of respondents indicated that they would remain in the fishing zone. The main reason given for this response was that it is profitable for fishermen when they encounter a zone with high shark catch.

All swordfish fishermen interviewed replied that they would change fishing position if the catch of sharks was especially high.

### **A2.13. Reasons for Discontinuing any Methods Attempted to Reduce Shark Interactions**

No fishermen interviewed had heard or tried a method to reduce shark interactions. However, over a quarter (26.5%) of mahi mahi fishermen mentioned that they use or have used wire leaders as a means to reduce shark damage.

### **A2.14. Perceptions on Efficacy and Commercial Viability of Strategies to Reduce Shark Interactions**

#### **A2.14.1. Avoiding peak areas and times of shark abundance**

Most (84.2%) mahi mahi fishermen believe that shark catch rates will be highest in certain areas which are different from those of the target species. As a result, almost three quarters (73.7%) believe that it is possible to avoid peak areas and times of high shark abundance. However, while some fishermen (14.2%) stated that they would do that in order to keep fishing for mahi mahi, others (28.6%) believe that avoiding peak shark areas is not profitable. Only 4% of all mahi mahi fishermen interviewed replied that an avoidance strategy is not possible because sharks are sometimes encountered along with the target species.

Two of three swordfish fishermen believed that it is possible to avoid areas of especially high shark abundance and one stated that he would stay in high catch shark zones if swordfish captures were equally high.

#### **A2.14.2. Reducing the detection of baited hooks by sharks, such as by refraining from chumming during the set and not discarding offal and spent bait during the haul**

More than half of mahi mahi fishermen (52.6%) believed that refraining from chumming during the set and refraining from discarding offal and spent bait during the haul will reduce shark depredation and bycatch. In contrast, two of three swordfish fishermen did not believe this strategy would be helpful in reducing interactions with shark species. Most mahi mahi fishermen mentioned that caught target species are usually gutted at port.

#### **A2.14.3. Limiting shark access to baited hooks, such as altering fishing practices to consider deployment depth of hooks and timing of the soak and haul to avoid problematic shark species**

Most (84.2%) mahi mahi fishermen believe that it is not possible to reduce shark interactions by setting baited hooks shallower or by reducing soaking time because they still have shark interactions when setting baited hooks shallower. In contrast, two of three swordfish fishermen believe it is possible.

#### **A2.14.4. Deterring sharks such as with chemical shark deterrents and electrical deterrents**

Only 21% of respondents believe that deterrents, such as chemical compounds and electrical current, will not be effective at reducing shark bycatch and depredation. Over two thirds (68.4%) of respondents believe that using shark deterrents would not be feasible since they would be very expensive and could damage target species and contaminate the ocean. One fisherman (5.6%) stated that he does not want to deter sharks, instead he wants to capture them due to their high economical value. Two swordfish fishermen replied that they did not know of these deterrents and whether or not they would be effective. The other swordfish fisherman believes that these deterrents will not be effective at reducing shark interactions.

#### **A2.14.5. Reducing the attractiveness of baited hooks to sharks, such as by using artificial baits, using or not using light sticks, or avoiding a bait type known to result in high shark catch rates**

Over a quarter (26.3%) of mahi mahi fishermen believe that avoiding bait types known to result in high shark catch rates would reduce shark interactions. About two thirds (63%) of respondents replied that these strategies would not be effective. Of these, two fishermen (16.7%) replied that shark interactions occur even when not using bait types typically employed for shark capture. Three respondents (25%) believe artificial bait would not be economically viable for mahi mahi capture since bait type for this target species is captured fresh before the setting of the longline. Two of three swordfish fishermen replied that they believe these strategies would reduce shark captures.



**A2.14.6. Reducing injury to hooked sharks that you will discard**

Almost a quarter (25.1%) of all respondents with mahi mahi as target species reported discarding small sharks alive. Of these, three quarters (75%) did not indicate a way to reduce injury to hooked sharks that they will discard, while the remainder replied that the use of dehookers will not reduce injury to hooked sharks for discarding. One respondent (5.3%) mentioned that he uses a dehooker to recover hooks from sharks when these are on board and already dead.

No swordfish fishermen reported discarding sharks alive. However, one of them said that they would discard blue sharks due low storage capacity. It is unclear whether or not they fin those sharks before discarding.

**A2.14.7. Reducing shark retention by avoiding a specific size or type of hook, or by not using wire leaders on branch lines**

Of mahi mahi fishermen, only one respondent (5.3%) replied that the size of the hook would affect the shark catch rate. About 36.8% (among whom there were fishermen that use both nylon and wire leaders) replied that shark retention is or would be reduced by not using a wire leader on their branch lines. Three fishermen (15.7%) that use wire leaders believe that using nylon monofilament would mean an increase in gear loss from sharks. Some respondents use nylon monofilament only because they believe that using wire leaders would decrease their target species capture during the summer. Wire leaders are used during shark season to increase shark capture.

Two swordfish fishermen indicated that not using wire leaders will reduce shark retention.

**A2.14.8. Will the economic impact of sharks be reduced from using a wire leader on branch lines**

Most respondents (73.7%) that fish for mahi mahi believe that the economic impact of sharks is or would be reduced by using a wire leader on branch lines. Among those respondents were all of the ones that use wire leaders and two thirds of fishermen that use nylon monofilament. One of the latter stated that he will not switch to wire leader because it would reduce his target species capture. However, another fisherman that use wire leaders mentioned that target species capture remains the same as if using nylon monofilament.

All three swordfish fishermen interviewed believe that the cost from damage to gear is or would be reduced by using wire traces on branch lines.

**A2.14.9. Most important factor that affects shark CPUE**

Over two thirds (68%) of mahi mahi fishermen believe that altering fishing position in relation to certain water temperatures alone will result in a high shark catch rate. The other third (32%) replied that a combination of different factors results in a high shark catch rate. Half of these respondents did not specify these factors. Equal amount of respondents replied (1) that altering fishing position and setting gear deeper will increase shark CPUE, (2) that time of month was an important factor along with altering fishing position in shark capture, or (3) that it is certain water temperatures together with time of the day that are the most important factors affecting shark CPUE. Respondents based their answer on their fishing practices during shark season.

According to all swordfish fishermen, it is a combination of different factors that will affect shark CPUE, but they did not specify these factors.

**A2.15. Incentives and Attitudes on Reducing Shark Bycatch and Depredation**

In general, both swordfish and mahi mahi fishermen interviewed (95%) are not interested in reducing shark bycatch. Forty-seven percent and 33.3% of mahi mahi and swordfish fishermen, respectively, are interested in reducing shark depredation.

The most common reason given by mahi mahi fishermen for not wanting to reduce shark interactions is because of the high value for shark meat and fins. Swordfish fishermen also mentioned that they do not want to avoid catching shark because it is profitable. Only one fisherman from a swordfish vessel replied that he wants to avoid shark interactions because they are not his target species.

Over two thirds (68.4%) of respondents believe, in the absence of restrictions on finning sharks, that bycatch during mahi mahi season would not mean a decline of shark populations. Two mahi mahi fishermen (9.1%) replied that shark bycatch during summer time is not high enough to threaten shark populations. Another two fishermen blamed industrial vessels for declines in shark populations due to finning aboard these vessels.

About 72% of respondents stated that their general feelings about sharks are that they are economically important. For them, sharks mean mostly extra income. One swordfish fisherman (4.5% of respondents) mentioned that it is sometimes annoying having many sharks in the line. Six (27.3%) respondents stated that sharks should be under sustainable management program. They believe shark populations have declined within the past years and that penalties, bans, and more control over industrial vessels should be enforced for conservation purposes.

## A2.16. Supporting Figures

Figs. A2.8 – A2.16 provide images of the fisheries described in this contribution.



Fig. A2.8. A typical artisanal mahimahi longline vessel from the port of Arica in northern Chile.



Fig. A2.9. An artisanal longline vessel in Arica using a monofilament mainline.



Fig. A2.10. Fisherman demonstrating an improvised de-hooker.



Fig A2.11. Multifilament mainline and hooks in stern of artisanal longline vessel.



Fig A2.12. Sample of J hook and leader used by artisanal vessels in Chile.



Fig. A2.13. Artisanal mahi mahi longliners in the port of Iquique.



Fig. A2.14. J hooks aligned in storage rack of artisanal longliner for mahi mahi, Iquique.



Fig. A2.15. Bow (left) and stern views of an industrial swordfish longline vessel in the port of Valparaiso.



Fig. A2.16. Offloading tuna from industrial swordfish vessel.

## A2.17. References

- ACUÑA E., CID, L. and E. PEREZ, I. KONG, M. ARAYA, J. LAMILLA & J. PEÑAILILLO. 2001. Estudio biológico de tiburones (marrajo dentado, azulejo y tiburón sardinero) en la zona norte y central de Chile. Informe final proyecto FIP N° 2000- 23. 128 pp.
- ACUÑA, E. and LAMILLA, J. 2004. Lineamientos Básicos para desarrollar el Plan de Acción Nacional del Tiburones. Antecedentes para la elaboración del Plan de Acción. Situación Actual de algunas pesquerías chilenas. Proyecto FIP 2004-18. Universidad Austral de Chile.
- BONFIL, R. 1994. Overview of world elasmobranch fisheries. FAO Fisheries Technical Paper 341. Rome, FAO. 125 pp.
- BARRIA M., P., DONOSO P., M., 2006. Seguimiento del Estado de Situación de las principales pesquerías nacionales. Pesquería Recursos Altamente Migratorios, 2005. Informe Final, BIP 30033825-0, Mayo 2006.
- CATARCI, C. 2004. World markets and industry of selected commercially-exploited aquatic species with an international conservation profile. FAO Fisheries Circular. No. 990. Rome, FAO. 186p.
- DIARIO OFICIAL. 1990. ESTABLECE NORMALES DE REGULACION PARA LA PESQUERIA DE PEZ ESPADA O ALBACORA. Ministerio de Economía, Fomento y Reconstrucción, Subsecretaria de Pesca. Nro 293, del 5 de Setiembre de 1990.
- DIARIO OFICIAL. 1994. REGULA APAREJO DE PESCA PARA LA CAPTURA DE LAS ESPECIES TIBURON O MARRAJO Y AZULEJO EN AREA QUE INDICA. Ministerio de Economía, Fomento y Reconstrucción, Subsecretaria de Pesca. Nro 99, del 19 de Enero del 1994.
- DIARIO OFICIAL. 2002. EXTIENDE AREA DE OPERACIONES PARA PESCA ARTESANAL DE ESPECIES TIBURONES MARRAJO Y AZULEJO. Ministerio de Economía, Fomento y Reconstrucción, Subsecretaria de Pesca. Nro 1307, del 25 de Junio del 2002.
- LEY 1971. Titulo 1 Del Limite Máximo de Captura por Armador.
- FAO FISHERY INFORMATION, DATA AND STATISTICS UNIT, 2006. Fisheries commodities production and trade 1976-2004. FISHSTAT Plus - Universal software for fishery statistical time series [online or CD-ROM]. Food and Agriculture Organization of the United Nations. Available at: <http://www.fao.org/fi/statist/FISOFT/FISHPLUS.asp>
- SERVICIO NACIONAL DE PESCA (SERNAPESCA), 2006. Anuarios estadísticos de Pesca. Años: 1990-2005. Ministerio de Economía, Fomento y Reconstrucción, Chile
- SERVICIO NACIONAL DE PESCA (SERNAPESCA). 2006a. Plan de Acción para Tiburones en Chile - Borrador. 2006. Propuesta Plan de Acción Nacional para la Conservación de Tiburones en Chile. Mayo 2006.
- VANNUCCINI, S. 1999. Shark Utilization, Marketing and Trade. FAO FISHERIES TECHNICAL PAPER 389, Rome, 1999.

## Appendix 3

### **Fiji Pelagic Longline Tuna Fishery: Industry Practices and Attitudes towards Shark Depredation and Unwanted Bycatch**

**Nicola Thomson, Environment Consultants Fiji,  
watling@connect.com.fj**

#### **A3.1. Introduction**

In this study we investigate: (i) The extent of wanted and unwanted shark by-catch and depredation in pelagic longline fisheries in Fiji Waters; (ii) existing industry (captains, crew, company directors) practices to respond to shark interactions and interest in reducing shark interactions; and (iii) industry opinion on the practicality, viability and acceptability to fishermen of different methods that could be used to reduce shark interactions with pelagic longline gear.

#### **A3.2. Methods**

We collected information for this study through: (i) Interviews of six fishermen, fleet owners and operators of the Fijian pelagic longline tuna fishery conducted between 19 and 31 August 2006; (ii) Fiji longline observer databases (held with the Fijian Department of Fisheries and the Secretariat of the Pacific Community); (iii) Fiji Bureau of Statistics trade data; and (iv) a literature review.

It was not possible to access Fiji logbook data from the Department of Fisheries as, according to the department, the data are not currently compiled in a form that can be summarised. However, logbook data that are included in the Department's annual report were used to develop conduct this study.

Of the 6 interviewees, 2 were owner-operators, 3 were captains but not vessel owners and 1 was a crew member. The 6 fishermen have been pelagic longlining between 8 and 20 years with a mean of 15 years (SD of 4.5) and have been longlining based from Fiji between 8 and 20 years with a mean of 13 years (SD of 4.9).

In addition, a number of experts were consulted for advice and information, these people were:

- Tim Lawson, Principal Fisheries Scientist, Oceanic Fisheries Programme, Secretariat of the Pacific Community;
- Deidre Brogan, Fishery Monitoring Supervisor, Oceanic Fisheries Programme, Secretariat of the Pacific Community;
- William Sokimi, Fisheries Development Officer, Oceanic Fisheries Programme, Secretariat of the Pacific Community;
- Apolosi Turaganivalu, Principal Administration Officer, Fiji Department of Fisheries;
- Neomai Turaganivalu-Ravitu, Fiji Department of Fisheries;
- Anare Raiwalui, Licensing Officer, Tuna Offshore Regulatory Unit;
- Grahame Southwick, Director, Fiji Fish Limited;

- Robert Stone, Fisheries Consultant, StoneFish (Fiji) Limited;
- Pio Manoa, Lecturer in Marine Policy, University of the South Pacific; and
- Niles Goundar, Oceans Campaigner, Greenpeace South Pacific Programme.

### A3.3. Fiji Fleet Characteristics

In 2006, 66 longline vessels were licensed to operate in Fiji's EEZ. Table A3.1 provides a summary of the number of tuna longline vessels licensed to fish in Fiji Waters over the last few years all of which come from the domestic fleet. Furthermore, foreign fishing vessels (mainly Taiwanese and Korean) operating outside Fiji's EEZ come to Fiji for transshipment and provisioning, some of these vessels also off-load their catch at Fiji seaports.

The total allowable catch for the tuna longline industry in Fiji Waters is 15,000 metric tons (Raiwailui Pers. comm., 2006). A total of 50,082,240 hooks were set by the Fiji longline tuna fleets in 2004, a total of 1,997 fishing trips were made by the same fleet that year (Fisheries Department, 2004). This is the most current year for which these statistics are available.

Longline vessels that are licensed to fish in Fiji waters range in size from 14.65 to 37 metres or 19 to 225 Gross Registered Tonnage (GRT). According to interviewees, the vessels that fish on the high seas and in other Pacific EEZ's quoted their vessel sizes as ranging from 33 to 40 GRT, while the vessels that only fish in Fiji's EEZ quoted their vessel size as ranging from 13 metres to 29 m.

There is an unquantified level of illegal, unregulated and unreported fishing in Fiji's waters. In a recent case, a Taiwan-owned vessel was charged for illegally targeting shark in Fiji waters. Section A3.7 provides more information about this case.

Table A3.1. Number of licences issued to tuna longline vessels to fish in Fiji waters (Fiji Department of Fisheries Annual Report, 2004; Raiwailui Pers. Comm.).

<b>Year</b>	<b>Number of Licences</b>
2002	103
2003	101
2004	84
2005	72
2006	66

### A3.4. Range of Fishing Gear and Methods

Table A3.2 summarises the general fishing methods and gear of the Fiji longline tuna fishery as indicated by the interviews described in Section 2.

Table A3.2. Fishing gear and methods of Fiji-based pelagic longline tuna fisheries.

Fishing gear and method	Interview Results	
	Only operate in Fiji's EEZ (4 interviewees)	Operate on High Seas, Solomons. Vanuatu and Fiji EEZs (2 interviewees)
Trip duration	9 days (2 days travel, 7 days fishing)	Around 30 days.
Number of sets per trip	7	20-25
Fishing grounds	Grounds vary depending on the season.	Fiji, Vanuatu, Solomon Islands EEZ and High Seas.
Fishing seasons	Seasonal, different areas are fished at different times of year.	Year round.
Annual effort (total catch)	80-100 tonnes.	3000 tonnes
Typical length of set (distance line is set over water)	35 to 40 nautical miles (65-74 km)	
Mainline material	Nylon	
Mainline average length	35 nautical miles	50 nautical miles
Distance between buoys	90 - 100 metres	700 metres
Distance from buoy to mainline (float line length)	10 fathoms	20 metres
Average branch line length	8 fathoms	15 metres
Branch line material	Nylon	
Wire trace or leader on branch lines	Yes, nylon leader (app. 40-45 Miles)	Yes, PE leader (0.5 metres)
Setting depth of hooks	60-90 fathoms	50-300 metres
Timing of set, soak, and haul	Set: 4 to 5am to 7am Haul: 3pm to 6pm	Set: 5am to 10 or 11am Haul: 12pm-2am
Lightstick use	Not used	Yes (3M product placed only on float)
Number of branchlines per set	2300-2400	2500
Number of branchlines between buoys	35	25
Number of hooks per set	2300 - 2500	2500
Hook type	B3 or Mustad	
Weight size and location	Interviewees did not know	
Clip size and type	Snap or U-Snap (4mm x 140)	
Bait type	Sardine and Pilchard	Pilchard (approx 80-90 grammes)
Number of crew	8 to 12 crew	

### A3.5. Catch and Discard Rates of Target and Bycatch Species

The data in Table 3 were provided by the Secretariat of the Pacific Commission's Oceanic Fisheries Programme (SPC OFP) which has compiled observer programme data provided by the Fiji Government. It is important to note that observer coverage is very low, particularly for 1999 to 2004, hence may not be representative. Observer coverage ranges from 4.51% to 0.34% of hooks observed out of the total fishing effort per year (Lawson, Pers. comm.).

<sup>1</sup> These vessels time at sea is limited to how long the ice that they carry can keep the fish frozen.



The data in Table A3.4 come from catch logsheets completed by vessels and provided to the Fiji Fisheries Department as a condition of the licence. Logsheets do not provide full coverage of activities and have been extrapolated by the Fisheries Department to account for missing data.

According to SPC data, over the five years for which observer programme data are available, sharks formed 3 - 10% of the catch per effort and 8 to 25% of the weight of the catch per effort.

According to the Fiji Fisheries Department's data in 2004, sharks comprise 6% of the total catch by weight that year while SPC indicated that sharks comprised 14%. Another contradiction is that, according to a 1999 study, sharks formed a major portion of the tuna longline fishery at that time. The data supplied by observers on local vessels showed that sharks comprised > 25% (by number) of the total catch, most of which was discarded (Swamy, 1999).

However, these data do not reflect what proportion of this catch was retained or discarded. SPC Observer Programme Data for 1999 and 2002 to 2005 (Table A3.5) indicate that, of the sharks that were observed being caught, 78 to 90% were finned and 82 to 94% were discarded. A significantly larger proportion of the shark catch was alive when hauled to the boat, most of the small proportion of sharks that were discarded were dead at that stage.

Tables A3.6 to A3.8 indicate catch, mortality and discard rates for the three most commonly caught shark species as indicated by SPC observer programme data. According to the data the three most commonly caught species in order of most to less common are: Blue Shark (*Prionace glauca*); Oceanic Whitetip Shark (*Carcharhinus longimanus*); and Silky Shark (*Carcharhinus falciformis*).

The data for each of the three species reinforce the pattern indicated by observer data which is that sharks are mostly alive when hauled in and mostly dead when discarded. This is contradicted by the interview results which state that the sharks are almost always dead when hauled to the boat.

The interviews with fishermen also gave different results for the most commonly caught sharks. According to the interviews with fishermen that only fish in Fiji Waters, sharks that are typically caught are: Makos, Brown Sharks and Blue Sharks<sup>2</sup>. One interviewee indicated that Brown and Blue sharks are the most destructive to their target catch, the rest of the interviewees were not sure. According to the interviewees, sharks are caught at a rate of roughly one to two sharks per set (2300 to 2500 hooks).

One interviewee commented that due to the fact that the length of their fishing trips are limited to around 9 days due to ice supplies they catch fewer sharks than Chinese and Japanese longliners which can stay at sea for much longer periods of time.

---

<sup>2</sup> The two interviewees that operate on the high seas and in the Vanuatu and Solomon Islands EEZs as well as Fiji's EEZ stated that the shark species that they catch vary depending on the fishing ground but that "White Shark" is the most common species that they catch, it is unclear which species they are referring to, the interviewees were Chinese and Korean, hence this may be the common name used for a particular species in their home region.

Table A3.2. Target Species (Tuna – Albacore, Bigeye, Yellowfin), Sharks and “Other” observed catch, Fiji Pelagic Longline Tuna Fishery Catch Data, 1999 and 2002-2005, for all fish caught regardless of whether retained or discarded, Source: SPC Observer Programme Data.

1999				
	No. /100 hooks	%	Kg/100 Hooks	%
<b>Tuna</b>	1.756	49	33.473	46
<b>Sharks</b>	0.3581	10	17.9829	25
<b>Other</b>	1.4837	41	21.0125	29
<b>Total</b>	3.5978		72.4684	
2002				
	No. /100 hooks	%	Kg/100 Hooks	%
<b>Tuna</b>	1.803	54	32.03	67
<b>Sharks</b>	0.0885	3	3.8017	8
<b>Other</b>	1.4646	44	12.236	25
<b>Total</b>	3.3561		48.0677	
2003				
	No. /100 hooks	%	Kg/100 Hooks	%
<b>Tuna</b>	1.323	62	24.414	62
<b>Sharks</b>	0.0819	4	4.3062	11
<b>Other</b>	0.7346	34	10.392	27
<b>Total</b>	2.1395		39.1122	
2004				
	No. /100 hooks	%	Kg/100 Hooks	%
<b>Tuna</b>	1.774	74	30.487	72
<b>Sharks</b>	0.1463	6	5.8829	14
<b>Other</b>	0.4633	19	6.2142	15
<b>Total</b>	2.3836		42.5841	
2005				
	No. /100 hooks	%	Kg/100 Hooks	%
<b>Tuna</b>	1.916	72	33.461	73
<b>Sharks</b>	0.1072	4	4.7502	10
<b>Other</b>	0.6489	24	7.6622	17
<b>Total</b>	2.6721		45.8734	

Table A3.3. Weight (mt) of Tuna, Shark and “other” species catch for Fiji Pelagic longline tuna fishery catch, for all fish caught in 2004 regardless of whether retained or discarded (licenced and provisionally licensed Fiji-based flagged longline vessels), Source: Fiji Fisheries Department Annual Report 2004.

Year	Tuna (mt) 1	% of Total Catch	Shark (mt)	% of Total Catch	Other (mt)	% of Total Catch
2002	-	-	1,277	-	4,290	-
2003	-	-	453	-	1,500	-
2004	16,708	85	1,189	6	1,720	9

1 Albacore, Yellow Fin and Bigeye Tuna

Table A3.4. Observed response to shark by-catch 1999 and 2002 to 2005, Fiji Pelagic Longline Tuna Fishery (SPC Observer Programme Data).

Year	Number sharks observed caught	% Discarded	% Finned	Number dead catch	Number alive catch	Number discarded dead	Number discarded alive
1999	434	82	86	1	28	2	5
2002	75	83	78	7	68	35	9
2003	277	93	89	29	248	110	10
2004	451	95	90	62	389	133	55
2005	892	94	89	172	720	587	144

Table A3.5. Blue shark, observed CPUE, number caught, number and proportion dead when hauled to vessel, 2002 to 2005, Fiji pelagic longline tuna fishery (SPC Observer Programme Data).

Year	CPUE (number caught per 100 hooks)	Number caught	% alive when hauled to the vessel	% discarded alive
2002	0.0349	29	100	23
2003	0.0425	145	95	2
2004	0.0896	277	95	27
2005	0.044	372	93	15

Table A3.6. Oceanic whitetip shark observed CPUE, number caught, number and proportion dead when hauled to vessel, 2002 to 2005, Fiji pelagic longline tuna fishery (SPC Observer Programme Data).

Year	CPUE (number caught per 100 hooks)	Number caught	% alive when hauled to the vessel	% discarded alive
2002	0.0186	16	88	0
2003	0.0169	57	81	0
2004	0.0164	50	82	13
2005	0.0288	245	65	11

Table A3.7. Silky shark observed CPUE, number caught, number and proportion dead when hauled to vessel, 2002 to 2005, Fiji pelagic longline tuna fishery (SPC Observer Programme Data).

Year	CPUE (number caught per 100 hooks)	Number caught	% alive when hauled to the vessel	% discarded alive
2002	0.0058	5	80	20
2003	0.007	23	70	0
2004	0.0071	22	68	7
2005	0.0161	131	81	6

### A3.6. Management Framework Relevant to Shark Interactions and its Effect on Fishermen

Within Fiji's EEZ, the fishery property rights belong to the State and are administered by the Fisheries Department. As shark is not managed as a separate fishery in Fiji there are currently no regulations on

its exploitation including no restrictions relating to catch, processing and handling of sharks and shark fins (Swamy, 1999, Raiwalui Pers. comm., 2006).

However, there has been a recent legal precedent whereby a vessel licensed to fish for tuna in Fiji waters was charged for illegally targeting shark rather than harvesting shark as by-catch. The vessel was licensed to fish for tuna in the offshore area of Fiji's Exclusive Economic Zone (beyond 12 nautical miles from the coast out to the border of the EEZ) but was targeting sharks in Archipelagic Waters (within 12 nautical miles from the coast), its hold held a large quantity of shark fillets and fins but no tuna. The charterer was charged FJ\$30,000. The vessel and cargo were also forfeited to the State. The cargo of shark product was sold for FJD 42,643.92 (Nakeke, 2006).

Sharks or shark products that have been caught outside of Fiji waters that are to be off-loaded at a Fiji port for processing or exported require a permit (Raiwalui Pers. comm., 2006). In 2004, a total of 652 permits were issued involving 70.7 MT of shark fin and 79.95 MT of shark meat. No permits are required for vessels that off-load shark by-catch that has been caught in Fiji waters (Fisheries Department, 2004).

The National Fisheries Observer Programme collects catch logs, scientific and unloading data and real time data on fishing vessels during fishing operations. In 2004, the observer programme is reported as having covered 1,143 of the 1,203 vessels operating (Fisheries Dept. Annual Report, 2004). The time period over which each vessel was covered is unclear. However, according to the Secretariat of the Pacific Community, in 1999 and from 2002 to 2005 observer coverage in Fiji Waters ranged from 4.51% to 0.34% of hooks observed out of the total fishing effort per year.

All vessels licensed to fish in Fiji Waters must operate an Automatic Location Communicator (ALC) which is monitored by Fiji's Vessel Monitoring System (VMS) which is managed by the Fiji Navy. The Fiji Navy also conducts sea and aerial patrols to detect and investigate suspicious vessel activity (Raiwalui Pers. comm., 2006).

In addition, random dockside vessel inspections are carried out by the Fisheries and Customs Departments to detect Illegal, Unregulated and Unreported Fishing (IUU). These inspections focus on vessels that have entered from outside of Fiji Waters but do include a proportion of domestic vessels (Fisheries Department, 2004, Raiwalui Pers. comm., 2006).

One interviewee, a company managing director commented that if regulations were put in place that required the entire shark to be retained on the vessel and/or taxed shark fin trading crews would be deterred from catching sharks.

### **A3.7. Current Response to Shark By-Catch by Fiji Pelagic Longliners**

#### **A3.7.1. Methods for onboard processing and discarding of sharks**

As the data in Section 5 indicates, Shark seems to form a significant portion of the by-catch for pelagic tuna longline fisheries in Fiji waters. Sharks are usually finned and the carcasses discarded back into the ocean. This was reinforced in the interviews, interviewees advised that the shark is hauled into the boat, killed if necessary, the hook is removed, the 3 fins and tail are cut and the remaining carcass is thrown back into the sea. The fins and tail are then sun-dried. The shark carcasses are generally discarded because there is relatively poor demand and market value for shark meat (Sokimi pers. comm. 1996, Swamy, 1999).

One contradiction between the SPC Observer data (Section 5) and the interviews was that while the observer data indicated that sharks are usually alive when they are hauled into the boat, interviewees stated sharks are normally dead by the time they are hauled in. Interviewees stated that as a result, dehooker type devices are not needed to release sharks. The two Managing Directors were the only interviewees that were of the opinion that the sharks tend to be alive when hauled into the boat. All interviewees commented that they never discard a shark that has been caught on the line without first finning it.

### **A3.7.2. Practices employed to reduce shark capture**

A Fisheries Development Officer from the Oceanic Fisheries Programme of the SPC who works closely with boat owners and crew in the region and has worked as a longline skipper in Fiji Waters advised that most in the industry have accepted shark by-catch as inevitable. Not much has been done to reduce shark interaction other than avoiding infested areas to some extent. He added that due to the economic hardship of crews and fishing operations, time and energy is not available for experimenting with practices to reduce shark interaction (Sokimi, Pers. comm., 1996).

Two interviewees commented that it is not possible to avoid catching sharks. Other interviewees listed the following measures that are used in some cases to avoid catching sharks:

- Avoid setting the lines/hooks in shallow water or near reefs or seamounts;
- Ensuring that the branch line is not near floats or buoys;
- Not using a small float; and
- Not allowing the crew to use a steel wire trace on hooks (steel wire causes more sharks to be caught as sharks can break the alternative nylon trace).

Interviewees perceived that there are no extra costs associated with using these methods and recommended them as effective methods to reduce shark catch. They added that they have not used other methods in the past nor did they recommend any additional methods as potentially useful.

### **A3.7.3. Distribution of revenue from sharks**

Sokimi (Pers. comm., 1996) advised that in Fiji, as with most regional tuna longline operations, dried shark fin is major supplement to the tuna longline fisherman's earnings.

According to Swamy (1999) and the interview results, the crew is at liberty to process shark fins and the proceeds from the sale of shark fins do not go to the vessel owners, but are shared among the crew. However, the two Managing Directors that were interviewed advised that the revenue goes to the "crew and company" and that they "do not encourage the crew to catch sharks". They added that the proceeds go to both the crew and the company which is contradiction of the crews' response.

### **A3.7.4. Ex-vessel value of landed sharks**

There is a shark fin and meat industry operating in Fiji (Kailola, 1995). Most of the shark products are exported, a small portion of the landings are distributed locally (Swamy, 1999).

Shark fins and tails are purchased by local shark fin traders. The value of the fin depends on the species, the type of fin, their completeness, and moisture content (a well-dried fin fetches a higher price). During 1997, prices paid to local fishermen ranged from FJ\$20 to 140 per kilogramme, the average price paid was FJ\$60 (Swamy, 1999). According to the fishermen interviewed for this study, the current market value for fins and tail is FJ\$60 to 200 per kilogramme. One interviewee advised that Brown Sharks fetch the highest price (FJ\$170/kg) followed by Blue Sharks (FJ\$100/kg) followed by Mako Sharks (FJ\$60/kg). Sokimi (pers. comm., 1996) reinforced that Brown followed by Blue sharks fetch the highest price for fins, he was of the opinion that Mako and Thresher Sharks have no value for fins.

One shark fin trader, Wellbeing Enterprise Limited states on a webpage that they can provide a stable supply of 2 tonnes (2000 kg) per month of dried shark fin from "black/brown sharks sourced from Fiji waters", its office is based in Korea ([http://www.alibaba.com/catalog/11000557/Shark\\_Fin.html](http://www.alibaba.com/catalog/11000557/Shark_Fin.html)).

It is interesting to note that Fiji is an appealing location for shark product export operations. There are tax incentives to offload shark products in Fiji for re-export to markets that give Fiji tax concessions. Moreover as shark fins are primarily an export product, shark fin exporters pay reduced taxes. Furthermore, there is no export duty on fishery products. Due to these favourable conditions for the operation of such agents it seems likely that the shark fin trade will continue to grow in Fiji (Swamy 1999).

The export data presented in Table 7 is the result of a combination of shark products caught in Fiji's waters and shark products offloaded by foreign vessels for re-export.

Table A3.8. Quantity and value of tuna and shark products exported from Fiji in 2003 (Fisheries Department Annual Report, 2004).

Species	Quantity (kg)	Revenue (FJD)
Tuna Products	15,941,747.23	56,578,349.00
Shark Products	180,567.80	1,762,267.00

#### A3.7.5. Revenue from catching sharks relative to economic costs from shark depredation and gear damage

Sokimi (pers. comm., 1996) is of the opinion that as long as the shark fin trade is in operation in Fiji, shark finning will continue to be a part of fishermen's activities. He added that even if legislation is put in place to prohibit the capture of sharks for the fins, he is of the opinion that that this would simply lead to the creation of a black market.

*According to the interviews with fishermen, the general perception seems to be that sharks cost more due to depredation and the time that crew spends processing them than they earn in revenue. However, all interviewees stated that the cost in terms of gear damage (hook and line), lost bait and loss of target species due to shark by-catch and depredation is very low.*

### A3.8. Current Response to Shark Depredation by Fiji Pelagic Longliners

#### A3.8.1. Frequency and effects of shark depredation

A 2001 study by the Oceanic Fisheries Programme of the SPC that used national observer programme data held by the SPC indicated that observed shark predation is at fairly low levels, ranging from 0.9 to 4.2% of observed caught tuna being discarded due to shark damage. In contrast levels of fish discarded due to whale damage were non-existent all years apart from a single fish being discarded in 1999 (Table A3.10). It is possible that the low percentages of whale-damaged tuna may be due to improper reporting by national observers. It is interesting to note that general fisherman perception seems to be that depredation due to whales is a much bigger issue (see Section A3.10 for more information).

The perception of interviewees is that shark depredation levels and associated costs in terms of gear, bait and lost target species are very low. Both Company Directors that were interviewed stressed that they were more concerned about the loss of target species due to Whales. A number of crew/captain interviewees commented that they do not think that sharks cause depredation.

Table A3.9. Total number of tuna observed and discards due to shark and whale damage in Fiji's EEZ, 1995-1997 and 1999 (Lawson, 2001).

Year	Total no. Tuna observed	Shark Damage		Whale Damage	
		Number	%	Number	%
1995	1,303	24	1.8	0	0
1996	429	4	0.9	0	0
1997	658	11	1.7	0	0
1998	-	-	-	-	-
1999	165	7	4.2	1	0.6

Table A3.10. Percentage of tuna catch discarded from observed catch 1999 and 2002 to 2005, Fiji pelagic longline tuna fishery (SPC Observer Programme Data).

Year	Albacore	Big Eye Tuna	Yellowfin Tuna
1999	2.41	12.65	24.31
2002	0.69	4.9	6.52
2003	1.04	6.59	5.09
2004	0.47	13.06	5.71
2005	1.10	9.17	4.53

### A3.8.2. Practices employed to reduce shark depredation

Sokimi (pers. comm., 1996) advised that not much has been done to reduce shark depredation other than avoiding infested areas. He added that due to the economic hardship of crews and fishing operations, time and energy is not available for experimenting with practices to reduce shark interaction.

Most interviewees advised that they do not do anything to avoid depredation nor have they done so in the past, some said that this is because nothing can be done, some said that this was because they do not think that sharks cause depredation. The only exception to this result was the two Managing Directors that were interviewed who commented that the same methods used to avoid by-catch also apply to avoiding depredation.

### A3.9. Perceptions on Efficacy and Commercial Viability of Strategies to Reduce Shark Interactions

Method	Interviewee perception	
	Work well	Cost effective
Avoiding peak areas and times of shark abundance	Yes – 6 Interviewees <i>“Chang[ing] fishing grounds to less infested waters is the only effective way to keep [sharks] away” (Sokimi pers. comm., 1996).</i>	Yes – 4 Interviewees No - 1 Interviewee No comment/Don't know – 1 Interviewee
Reducing the detection of baited hooks by sharks, such as by refraining from chumming during the set and not discarding offal and spent bait during the haul	Yes – 2 Interviewees No – 4 Interviewees	No – 2 Interviewees No comment/Don't know – 4 Interviewees
Limiting shark access to baited hooks, such as altering fishing practices to consider deployment depth of hooks and timing of the soak and haul to avoid problematic shark species	Yes – 6 Interviewees	No comment/Don't know – 6 Interviewees
Deterring sharks such as with chemical shark deterrents such as soap and shampoo derivatives (pardaxin, sodium and lithium lauryl sulfate, and sodium dodecyl sulfate), and electrical deterrents such as the Shark Protective Ocean Device used by SCUBA divers	No - 3 Interviewee No comment/Don't know – 3 Interviewees	Interviewees were not sure about whether this would work and how much it would cost. <i>Sokimi (pers. comm., 1996) – more experimentation is needed of efficacy of sound devices.</i>
Reducing the attractiveness of baited hooks to sharks, such as by using artificial baits, using or not using light sticks, or avoiding a bait type known to result in high shark catch rates	No - 3 Interviewee No comment/Don't know – 3 Interviewees	Interviewees were not sure about whether this would work and how much it would cost. <i>Sokimi (pers. comm., 1996)</i>

		– <i>more experimentation is needed of efficacy of light attachments to gear.</i>
Reducing injury to hooked sharks that you will discard, such as by using dehookers, which may change the degree of risk of injury to crew from current practices	No - 2 Interviewees No comment/Don't know – 4 Interviewees	Interviewees were not sure about whether this would work and how much it would cost.
) Reducing shark retention by avoiding a specific size or type of hook, or by not using wire leaders on branch lines	Yes – 2 Interviewees No - 1 Interviewee No comment/Don't know – 3 Interviewees	No - 1 Interviewee No comment/Don't know – 5 Interviewees
i) What is the most important factor that affects shark CPUE - altering fishing position in relation to certain water temperature, topographic features, or oceanographic features; changing the time of day or month of setting or hauling; changing the depth of hooks, or a combination of these factors?	Altering fishing position in relation to: topographic features (6 interviewees agreed); depth of hooks (5 interviewees agreed); certain water temperature (4 interviewees agreed); Oceanographic features, e.g. currents, fronts (1 interviewee agreed); Time of day and month (1 interviewee felt that this may make a difference, 2 stated that this would not make a difference).	

### A3.10. Incentives and Attitudes on Reducing Shark Bycatch and Depredation

Sokimi (pers. comm., 1996) is of the opinion that currently Pacific Island fishermen think that it is to their benefit to reduce the size of shark populations. He explained that fishermen perceive sharks as a nuisance due to depredation and the danger sharks pose to them if they ever have to abandon ship. He adds that sharks that are caught by longliners are perceived by crew as an economic opportunity. He warns that, unless it can be clearly demonstrated to fishermen that there is an economic advantage to avoiding catching sharks, they will not cooperate with avoidance measures. He advised that the industry is likely to be willing to cooperate with trials if they are subsidised to do so.

The interview results contradicted Sokimi's comments. *All interviewees, apart from one captain, stated that captains and crew were interested in reducing shark by-catch and depredation.* The general opinion of the interviewees was that while they provide good income for the crew, not enough are caught for the return to be worthwhile. The general opinion is that the time lost in processing the sharks and the lost bait and target species is not worth the income generated. Both Managing Directors clearly stated that their companies do not encourage the catching of sharks as this takes time away from fishing for the target species and that the shark fishery should be sustainably managed. All interviewees categorically stated that they would avoid shark capture if they could as long as this did not lower their catch of target species.

Somewhat contrarily, the interviewees estimated the opinion that the cost of shark interaction in terms of gear, bait and lost target species catch is low. All the interviewees that work as captains or crew commented that it would be good if a special hold was allocated on boats for shark meat and a market identified so that the meat does not go to waste (i.e. currently discarded overboard) and additional income is generated for the crew. In contradiction one interviewee, a company Managing Director, commented that if regulations were put in place that required the entire shark to be retained on the vessel and/or taxed shark fin trading, crews would be deterred from catching sharks.

Brogan (pers. comm., 1996) advised that in working alongside the Fiji tuna longlining industry for a number of years, she is not aware of any strong negative reactions by industry to shark depredation, rather her perception is of a "stoic acceptance". She added that this contrasted strongly with the problem



of whale depredation which fishers regularly voice concern about. When working on a project relating to whale depredation a number of years ago, she found that even when she pointed out that shark depredation levels were higher (based on observer data at the time) fishers remained focussed on the problem of whale depredation<sup>3</sup>.

Three interviewees advised that the best way to share information about how to avoid shark by-catch and depredation would be through picture posters supplied to companies to put up in crew workplaces.

### A3.11. References

- Anon (1999) Case Studies of the Management of Elasmobranch Fisheries. FAO Fisheries Technical Paper, no. 378, pt. 1, FAO, Rome.
- Bailey, K., Williams, P., Itano, D. (1996) By-catch and Discards in Western Pacific Tuna Fisheries: A Review of SPC Data Holdings and Literature. Technical Report of the Oceanic Fisheries Programme, South Pacific Commission, no. 34, pp. 148. Noumea, New Caledonia.
- Bonfil, Ramon (1994) Overview of the World Elasmobranch Fisheries. FAO Fisheries Technical Paper, no. 341, FAO, Rome.
- Catarci, C (2004) World markets and industry of selected commercially-exploited aquatic species with an international conservation profile. FAO Fisheries Circular no. 990, pp. 186, FAO, Rome.
- Fiji Department of Fisheries (2004) Annual Report 2004, Ministry of Fisheries and Forests, Government Printer, Fiji.
- Kailoloa, J.P. (1995) Review of Policies and Initiatives to Enhance Fisheries Management and Development in Fiji. A report prepared for the Government of Fiji. FAO Technical Report 3, pp.105.
- Lawson, T. (2001) Predation of Tuna by Whales and Sharks in the Western and Central Pacific Ocean. 14 Meeting of the Standing Committee on Tuna and Billfish, Working Paper SWG-6.
- Nakeke, A. 2006. Judge Orders Sale of Illegal Catch, Impounds Ship. Fiji Sun Newspaper, 27 February 2006.
- Swamy, K. (1999) Shark Fisheries in Fiji: their management and issues for future concern. In: In: FAO. Case Studies of the Management of Elasmobranch Fisheries. FAO Fisheries Technical Paper, No. 378, part 1, FAO, Rome.
- Williams, P.G. (1999) Shark and Related Species Catch in Tuna Fisheries of the Tropical Western and Central Pacific Ocean. In: FAO. Case Studies of the Management of Elasmobranch Fisheries. FAO Fisheries Technical Paper, No. 378, part 1, FAO, Rome.

---

<sup>3</sup> There is some evidence to suggest that when whale predation occurs, whales can take a much larger proportion of the set, including the entire set at times. Hence, although whale predation incidents are rare compared to shark predation, the effects can be more extreme when they do occur (Lawson, 2001).

## Appendix 4

### **Italy Mediterranean Industrial Pelagic Longline Swordfish Fishery: Industry Practices and Attitudes towards Shark Depredation and Bycatch**

**Susanna Piovano, Department of Animal Biology, University of  
Torino, susanna.piovano@unito.it**

#### **A4.1. Introduction**

A literature review on the industrial drifting (pelagic) longline in Italy raises several issues. First, it is necessary to distinguish between the artisanal and industrial fisheries. In Italy, there is a legal distinction between small and large scale fishing. The small scale fishing is defined by Ministerial Decree 14 September 1999 as: artisanal fishing done with vessels shorter than 12 m, lower than 10 TSL and 15 GT of tonnage, practised with specific gear (longline included), within 12 miles off the coast. According to this definition, drifting longline for large pelagic species is 'large scale' fishing. However, Italian drifting longline vessels are mainly fishermen owned, with small financial investments, usually without gear mechanization, and with relatively short trips of nearly a week. Despite the legal definition, these characteristics are commonly associated with artisanal fishing.

Interviews with fishermen working on big, "nearly industrial" longline vessels were conducted to determine the exact type of fishing activity. This study focuses on the Italian pelagic longline fleet that targets swordfish in the Mediterranean, excluding small coastal vessels (MAGP Segments, Commission Regulation (EC) No. 2091/98 of 30 September 1998).

A second issue that requires addressing is the distinction between gear types in official statistics. In Italy fishing licenses are regulated by a Ministerial Decree of 26 July 1995. The Decree groups permitted fishing gear according to homogeneous classes, defined as "fishing systems". Permission to fish with a system means permission to fish with any gear included in that system. Unfortunately, the longline fishing system includes both drifting and set (demersal) longline gears. Thus, official statistics (compiled by ISTAT - Italian Institute of Statistics, in 2004 and 2006, and by IREPA - Institute for Economic Research for Fishing and Acquacolture, 2006) group data on both demersal and pelagic longline gear; data are not available just for pelagic longline gear.

Some local studies are available with data for drifting longline by-catches only: these studies are based on interviews and on-board or at landing surveys.

Information from the literature was complemented with information from interviews with fishermen of Sicily. Interviews, carried out through the cooperation of AGCI Pesca, were conducted between August and December 2006, and a total of 15 large-scale longline fishing vessels were involved.

All the interviewed fishermen are owner or co-owner operators. The 17 fishermen have been pelagic longlining between 6 and 50 years with a mean of 29.7 years, during which they never change their port-based.

We selected fishermen that operated with longline vessels with a TSL bigger than 10 and a LFT bigger than 12 m. The type of fishing license range from "coastal fishing" 20 or 40 nm, and the Mediterranean one.

## A4.2. Fleet Characteristics

The last available statistics calculated with data from the Italian Fishing Licence Register date back to 2004 and combine small-scale and large-scale longline fisheries. The Register includes a total of 14,873 vessels. Of these, 569 vessels are identified as using longline gear (Tables A4.1 and A4.2) as their main fishing gear (the fishing gear considered to be the most frequently used on board for a fishing period of a year – Commission Regulation (EC) 26/2004). As mentioned in the introduction, no official data are available just for drifting pelagic longline gear.

Table A4.1. Characteristics of the Italian small-scale and large-scale longline (drifting and set) fleet, by geographic area, 2004 (IREPA, 2006).

Area	Vessels	%	GT	%	TSL	%	kW	%	TSL mean	GT mean
Sicily	317	56	9,267	81	7,777	80	54,112	69	25.0	29
Adriatic, Ionian	137	24	1,512	13	1,154	12	15,295	19	8.4	11
Tyrrhenian	115	20	706	6	760	8	9455	12	6.6	6
Total	569	100	11,485	100	9,691	100	78,861	100	17.0	20

Table A4.2. Italian small-scale and large-scale pelagic and demersal longline fleet: fishing days, catches, revenues, and price, 2004 (IREPA, 2006).

	Total values			Average values/vessel			Average values/day		
	Days	Catch (t)	Revenue million €	Days	Catch (t)	Revenue (000 €)	Catch (kg)	Revenue €	Price €/kg
Sicily	52,084	6,761	64	153	20	187	130	1,226.46	9.45
Adriatic	2,440	648	4	51	14	81	266	1,585.81	5.97
Ionian	13,229	921	6	142	10	65	70	457.96	6.58
Tyrrhenian	20,835	966	9	177	8	80	46	451.64	9.74
Total	88,588	9,296	83	148	15	139	105	939.37	8.95

Tables A4.1 and A4.2 show that the Sicilian longline fleet is the largest and most efficient (56% of vessels, 73% of catches). Mean values per vessel are high (153 days/vessel, 20 tons of fish/vessel). Drifting longline catching for swordfish in Sicily has been known for more than two centuries, so Sicilians are specialized in fishing with this kind of gear. Target species are swordfish (54% of total catches), Northern bluefin tuna and albacore (IREPA, 2006).

In 1997, UNIMAR consortium took up a census of all fishing companies for the Italian Ministry of Agricultural Politics. From 1999 to 2000, data from fishing licences and official statistics, recording generic "multiple use" fishing, have been improved with interviews to fishermen, to settle the actual use of each fishing gear (UNIMAR, 2001). According to UNIMAR census, 15,593 vessels were active in Italy in 1997. In 1999 there were an estimated 1,519 pelagic drifting longline vessels (9.7%) (Table A4.3).

The number of large-scale vessels fishing for tuna and swordfish with longline gear has changed over the past few years. For examples, the number of large vessels authorized for fishing with longline decreased from 31% in 1997 to 20% in 2005 (government data from Port authorities of Marsala, 2006).

Table A4.3. Number of all Italian vessels using drifting pelagic longline gear and total number of fishing vessels, by coast, 1997-1999 (UNIMAR, 2001).

Coast	Ligurian	Tyrrhenian			Adriatic			Ionian	Sicilian	Sardinian	Italian
		high	med	low	high	med	low				
DLL vessels	7	24	191	54	2	8	28	15	1,066	124	1,519
Total vessels	698	788	743	1,933	1,358	3,444	1,379	826	3,277	1,147	15,593

### A4.3. Fishing Gear

The mainline is made of braided polyamide (nylon) filament, while the branch lines are made of polyamide monofilament. Council Regulation (EC) 1626/1994 established a 60 km limit for the length of main lines for longline vessels. Swordfish vessels begin to set gear in the late afternoon by hand (no mechanization), the gear soaks during the night and is hauled with a line hauler.

In the area investigated, the colour of both main and branch lines, vessel power, trip length and fishing days, vary among vessels.

Tables A4.4a and A4.4b include information on pelagic longline gear characteristics from the literature, while Table A4.4c is based on information obtained from interviews.

Table A4.4a. Main characteristics of a generic Italian drifting longline gear (Ferretti et al., 2002).

Target	Mainline		Branch line				Hook
	Type	Diam. mm	Type	Diam. mm	Length m	Distance m	Type
Albacore	PA mono	1.2	PA mono	0.8	8	20	Mustad (flattened) 6
Swordfish	PA mono	1.8 - 2	PA mono	1.6	10	50	Mustad (eye) 0-1

Table A4.4b. Main characteristics of swordfish and albacore Italian longline fishing gears (Ferretti et al., 2002; Megalofonou, 2000).

Fishing Gear	Swordfish	Albacore
Fishing season	June-October	October-December
Mainline deployment	Manual	Manual
Distance between buoys	80-120 m	80-100 m
Branch line length	5->10 m	about 6 m
Branch line material	nylon monofilament (140)	nylon monofilament (diameter less than 1 mm)
Distance between branch lines	30-40 m	15-20 m
Average maximum depth of hooks when set	35 m	15 m
Timing of set and haul	Set begins in the late afternoon, hauling occurs in the first hours of the new day	Set at night, hauled after sunrise
Number of hooks per set	1,000 to 2,800	1,000 to 4,000
Radio beacons distance	3 km	-
Hook size	0-2	7-8
Bait type	Frozen mackerel ( <i>Scomber scombrus</i> or <i>S. japonicus</i> )	Frozen <i>Sardina pilchardus</i>

Table A4.4c. Main characteristics of swordfish longline fishing gear of Sicily-based vessels, based on interviews.

Trip duration	7-10 dd
Number of set per trip	6-9
Number of trips per year	12-16
Fishing grounds	Strait of Sicily all year round, Tyrrhenian Sea and Channel of Sardinia seasonally
Fishing season	Year-round, with a major effort in July-September. Every year fishing vessels are subject to a no-fishing period.
Mainline material	Nylon monofilament or polyamide multifilament
Mainline length	Max length allow: 60 km
Mainline deployment	Manual
Distance between buoys	150-300 m
Distance from buoy to mainline (float line length)	13-18 m
Average branch line length	18 m

Branch line material	Nylon monofilament
Wire trace or leader on branch lines	No
Number of hooks between buoys	4-8
Average maximum depth of hooks when set	60 m
Average maximum depth of mainline when set	45 m
Timing of set, soak, and haul	Set in the evening, soak in the night and haul in the first hours of the new day
Lightstick use	One per hook branch line
Lightstick position	Half branch line
Number of hooks per set	800-1400
Radio beacons distance	8-12 per set
Hook type	J
Hook size	8-9 cm length
Bait type	Frozen mackerel ( <i>Scomber scombrus</i> or <i>S. japonicus</i> )
Number of crew	Captain and 4-5 crew
Vessel Monitoring System	Blue Box

#### A4.4. Shark Bycatch

According to Megalofonou *et al.* (2000), at least 10 species of pelagic sharks<sup>1</sup> are captured as by-catch by the Mediterranean large pelagic fishery. These species by order of importance are: blue shark (*Prionace glauca*, IUCN Red List assessment 2006 NT), shortfin mako (*Isurus oxyrinchus*, NT), thresher shark (*Alopias vulpinus*, DD), porbeagle (*Lamna nasus*, VU, CR Mediterranean), tope shark (*Galeorhinus galeus*, VU, DD Mediterranean), bigeye thresher (*Alopias superciliosus*, DD), sandbar shark (*Carcharhinus plumbeus*, NT), basking shark (*Cetorhinus maximus*, VU, CITES Appendix II), bluntnose sixgill shark (*Hexanchus griseus*, NT), and the smooth hammerhead (*Sphyrna zygaena*, NT).

Sharks are considered to be of moderate economic importance for the Italian fishery. In 2004 shark catches were 0.47% of all gear fish catches and revenue from sharks was only 0.57% of total fish revenue (IREPA, 2006) (Table A4.5).

Table A4.5. Italian fishing fleet: catches of sharks in 2004 (IREPA, 2006).

	Catch (t)	Revenue (mln €)	Price €/kg
Sharks	951	4.66	4.90
Total fish	201,230	814.42	4.05

There is no Italian longline fishery that targets sharks. Traditional fishing activities with demersal longline targeting chondrichthyans, such as bluntnose sixgill shark (*Hexanchus griseus*) fishing in the Ionian Sea and kitefin shark (*Dalatias licha*) fishing in the Ligurian Sea, have long been abandoned (Vacchi & Notarbartolo di Sciara, 2000).

Shark finning does not occur on Italian vessels (Orsi Relini, 2000). In any case, Council Regulation (EC) 1185/2003 provides that removing shark fins on board, retaining and sell them is prohibited.

Sharks are captured mainly by trawlers (32.4%) and small scale fishing practices (54.4%), or as by-catch of longliners (5.3%) (Table A4.6) (IREPA, 2006).

<sup>1</sup> For this Appendix, the term 'sharks' is used *sensu stricto*, excluding skates, rays and holocephalans.

Table A4.6. Italian fleet: shark catches, revenue and price, 2004 (IREPA, 2006).

	Catches (t)	Revenue (mln €)	Price €/kg
Trawlers	308	1.73	5.64
Small scale	517	2.58	4.98
Longliners	50	0.09	1.88
Total	951	4.66	4.90

Official data and statistics on shark catches and by-catches suffer from the same, already mentioned problem: no data are available for drifting longline only, because drifting and set gears are included in the same class (Table A4.7), which also includes small- and large-scale fisheries.

Table A4.7. Small-scale and large-scale pelagic and demersal longline Italian fleet: catches of sharks and target species, 2004 (IREPA, 2006).

	Catch (t)	Revenue (million €)	Price €/kg
Sharks	50	0.09	1.88
Swordfish – <i>Xiphias gladius</i>	3,884	46.98	12.10
Northern bluefin tuna – <i>Thunnus thynnus</i>	319	2.28	7.13
Albacore – <i>Thunnus alalunga</i>	1,115	4.32	3.88
Total fish	8,782	79.17	9.02

Moreover, official trend data on shark catches are of limited utility and difficult to interpret because many species of small and medium sized sharks are generically recorded as “palombo” (*Mustelus* spp.) (De Metrio et al., 1982b; Vacchi & Notarbartolo di Sciara, 2000) and so reported to international bodies (Table A4.8).

Table A4.8. Italian fishing fleet: catches of smooth-hounds (*Mustelus* spp.) in the Mediterranean sea during 1995-2004 (FAO Fishstat Plus - GFCM Capture Production 1970-2004).

Year	1995	1996	1997	1998	1999	2000	2001	2002	2003	2004
tons	5,942	2,659	621	636	440	462	369	325	423	483

According to Vannuccini (1999), the main shark species caught by the Italian fleet as by-catch are blue sharks (*Prionace glauca*), thresher (*Alopias vulpinus*) and porbeagle (*Lamna nasus*). Di Natale (1998) enclosed a list of shark species reported in the by-catch of the Italian longline large pelagic fishery: *Alopias vulpinus*, *Alopias superciliosus*, *Carcharhinus brevipinna*, *Carcharhinus limbatus*, *Carcharhinus obscurus*, *Carcharhinus plumbeus*, *Prionace glauca*, *Cetorhynchus maximus*, *Heptanchias perlo*, *Hexanchus griseus*, *Carcharodon carcharias*, *Isurus oxyrinchus*, *Lamna nasus*, *Eugomphodus taurus*, *Odontaspis ferox*, *Sphyrna zygaena*, *Sphyrna mokarran*, *Sphyrna* sp., *Squalus acanthias*, *Squalus blainvillei*, *Galeorhinus galeus*, *Mustelus mustelus*. The same author (Di Natale, 1998) also reported that some shark species, such as *Alopias* spp., *Isurus oxyrinchus*, *Lamna nasus*, are usually marketed, while other species are sometimes marketed (*Prionace glauca*, *Carcharhinus* spp., *Carcharodon carcharias*, *Squalus* spp., *Heptanchias perlo*, *Hexanchus griseus*, *Mustelus* spp., *Sphyrna* spp.). Guglielmi et al. (2000) reported that *Prionace glauca* is marketed only by some fisheries (mainly on Adriatic Sea coast), while other species (*Isurus oxyrinchus* and *Lamna nasus*) are valuable and usually marketed. De Metrio et al. (1982a), in a paper related to blue shark dynamics of fishing in the Salento area (North Ionian Sea), reported a trade of this species, with more than 1,000 specimen totally landed in 1979-1980.

Quantitative data about drifting longline shark by-catch are available from a few papers. We subdivide bibliographic material according to the seas where the studies were carried on. Unfortunately, these papers usually do not provide separate data for small-scale and large-scale longline fisheries.

#### A4.5. Mediterranean Sea

Megalofonou et al. (2005) conducted a study of incidental catches and discards of pelagic sharks from the swordfish and tuna fisheries in the Mediterranean Sea. Data were taken onboard and at fishing ports from 1998 to 2000 (Table A4.9). Sharks comprise about 18% of the total catch of the Italy Mediterranean Sea large pelagic longline fishery. Blue shark (*Prionace glauca*) was the main by-

catch species in all gears and areas examined. The next most abundant species were shortfin mako (*Isurus oxyrinchus*), thresher shark (*Alopias vulpinus*), and tope shark (*Galeorhinus galeus*) (Megalofonou et al., 2005). Table A4.10 shows data related to Italian waters recorded onboard during a study by Megalofonou et al. (2005), where the average shark combined species CPUE of the four fishing areas was 0.744 sharks combined species per 1000 hooks.

Table A4.9. Catches: percentage composition of species by fishing gear in the large pelagic longline fisheries of the Mediterranean Sea, 1998-1999 (Megalofonou et al., 2005).

	% species at landing sites			% species on board			% species all		
	SWO	ALB	BFT	SWO	ALB	BFT	SWO	ALB	BFT
Sharks	19.01	0.37	—	9.64	0.26	2.10	17.67	0.32	2.10
Swordfish	75.46	30.47	—	67.77	5.07	1.36	74.37	17.97	1.36
Northern bluefin tuna	2.39	4.21	—	2.44	13.00	94.99	2.40	8.54	94.99
Albacore	0.07	60.95	—	0.05	76.32	0.00	0.07	68.52	0.00
Other	3.07	3.99	—	20.10	5.35	1.56	5.51	4.66	1.56

SWO = swordfish longline, ALB = albacore longline, BFT = Northern bluefin tuna longline

Table A4.10. Fishing sets, effort (x1000 hooks or 1000 m of net) and catch rates (number of fish/1000 hooks) of sharks and target species in the swordfish longline fisheries of the Mediterranean Sea, 1998-1999 (Megalofonou et al., 2005)..

Area	Sets	Effort	<i>Prionace glauca</i> CPUE	<i>Alopias vulpinus</i> CPUE	<i>Galeorhinus galeus</i> CPUE	Other sharks CPUE	SWO CPUE
Ionian	140	267.4	0.759	0.000	0.000	0.004	3.152
Adriatic	69	166.3	1.678	0.048	0.000	0.000	3.879
Tyrrhenian	9	18.5	0.270	0.000	0.000	0.000	8.428
Strait of Sicily	23	46.4	0.065	0.022	0.022	0.108	14.526

Guglielmi *et al.* (2000) present data from onboard observations during fishing seasons 1998-1999. Sharks were caught by swordfish, albacore and Northern bluefin tuna longline vessels in the Central Mediterranean Sea (Table A4.11).

Table A4.11. CPUE (N/1000 hooks, kg/1000 hooks) of sharks caught by swordfish, albacore and Northern bluefin tuna longline vessels in the Central Mediterranean Sea in 1998-1999 (Guglielmi *et al.*, 2000).

Shark Species	CPUE (N/1000 hooks)	CPUE (kg/1000 hooks)
<i>Prionace glauca</i>	0.223	13.949
<i>Alopias vulpinus</i>	0.011	0.891
<i>Carcharhinus plumbeus</i>	0.022	0.368
<i>Galeorhinus galeo</i>	0.006	0.061
<i>Isurus oxyrinchus</i>	0.011	0.863
<i>Lamna nasus</i>	0.011	0.824
<i>Sphyrna zygaena</i>	0.006	0.334

Di Natale & Pelusi (2000, quoted in Commission of the European Communities, 2003) showed data about shark by-catches of drifting longline vessels (Table A4.12).

Table A4.12. Average weight and CPUE (N/1000 hooks, kg/1000 hooks) of shark catches by drifting longline vessels in 1998-1999 (Di Natale & Pelusi (2000) in Commission of the European Communities, 2003).

Shark Species	CPUE (N/1000 hooks)	CPUE (kg/1000 hooks)
<i>Prionace glauca</i>	0.28	17.4
<i>Alopias vulpinus</i>	0.01	0.3
<i>Carcharhinus plumbeus</i>	0.03	0.5
<i>Galeorhinus galeo</i>	0.01	0.1
<i>Isurus oxyrinchus</i>	0.01	1.1
<i>Lamna nasus</i>	0.01	1.0
<i>Sphyrna zygaena</i>	0.01	0.4

**A4.5.1. Adriatic Sea**

Marano *et al.* (1988) and De Zio *et al.*, (2000) present landing data at the port of Monopoli on the South Adriatic Sea, from 1984 to 1987 and from 1991 to 1998. Blue shark (*Prionace glauca*) has the greatest by-catch rate (Table A4.13).

Table A4.13. Average weight and CPUE (N/1000 hooks, kg/1000 hooks) of blue shark landed at Monopoli from drifting longlines during 1984-1987 and 1991-1998 (Marano *et al.*, 1988; De Zio *et al.*, 2000).

	1984	1985	1986	1987	1991	1992	1993	1994	1995	1996	1997	1998
Average weight	16.29	17.03	15.98	11.63	14.18	8.36	10.12	9.77	11.81	11.71	10.69	10.81
CPUE (N/1000 hooks)	0.71	0.76	1.72	0.97	0.89	2.39	1.52	0.55	1.12	0.69	1.14	1.87
CPUE (kg/1000 hooks)	11.55	12.90	27.42	11.33	12.64	19.95	15.35	5.41	13.24	8.12	12.16	20.21

De Metrio *et al.* (2000) present data taken onboard drifting longline vessels in 1998, for the port of Savelletri on the South Adriatic Sea. Blue sharks (*Prionace glauca*) still represented the main by-catch rate, followed by thresher sharks (*Alopias vulpinus*) (Table A4.14).

Table A4.14. Blue shark and thresher shark catches and CPUE recorded at Savelletri (South Adriatic Sea) from drifting longlines fisheries in 1998 (De Metrio *et al.*, 2000).

	<i>Prionace glauca</i>	<i>Alopias vulpinus</i>
Average weight	18.7	115.2
CPUE (N/1000 hooks)	1.5	0.1
CPUE (kg/1000 hooks)	27.3	1.3

**A4.5.2. Ionian Sea**

De Metrio *et al.* (1984) present data on blue shark by-catch collected at landing at the port of Porto Cesareo on the North Ionian Sea. The survey was carried out from 1978 to 1981 (Table A4.15).

Table A4.15. CPUE (kg/1000 hooks) of blue shark landed at Porto Cesareo from drifting longline vessels, 1978 to 1981 (De Metrio *et al.*, 1984).

	1978	1979	1980	1981
Swordfish drifting longline: <i>P. glauca</i> CPUE (kg)	0.138	0.524	0.285	0.463
Albacore drifting longline: <i>P. glauca</i> CPUE (kg)	0.020	0.019	0.017	0.004

Other data are available for the same port (De Metrio *et al.*, 2000). Table A4.16a presents statistics about blue shark (*Prionace glauca*) by-catches observed on vessels targeting swordfish and albacore in 1998. Table A4.16b presents statistics on blue sharks landed at Porto Cesareo in 1998. A complete shark by-catch report covering 1978-1985 is given by Filanti *et al.* (1986) for longlines targeting swordfish (Table A4.17). Data were collected by on-board observers.

Table A4.16a. Average weight and CPUE (N/1000 hooks, kg/1000 hooks) of blue shark observed on board of Porto Cesareo drifting longline vessels in 1998 (De Metrio *et al.*, 2000).

	<i>Prionace glauca</i>	
	Swordfish drifting longline	Albacore drifting longline
Average weight	24.1	22.9
CPUE (N)	0.9	0.3
CPUE (kg)	21.8	6.1



Table A4.16b. Average weight and CPUE (N/1000 hooks, kg/1000 hooks) of blue shark landed at Porto Cesareo from drifting longlines in 1998 (De Metrio et al., 2000).

<i>Prionace glauca</i>		
	Swordfish drifting longline	Albacore drifting longline
Average weight	25.4	22.9
CPUE (N)	0.4	0.06
CPUE (kg)	9.7	1.4

Table A4.17. CPUE (N/1000 hooks) of sharks observed on board of Porto Cesareo drifting longline vessels targeting swordfish from 1978 to 1985 (Filanti et al., 1986).

	1978	1979	1980	1981	1982	1983	1984	1985
<i>Prionace glauca</i>	1.53	1.13	0.94	2.25	1.40	3.07	1.12	1.17
<i>Lamna nasus</i>	0.220	0.184	0.218	0.016	0.013	-	-	-
<i>Sphyrna zygaena</i>	0.043	0.044	0.007	-	-	-	0.03	0.003
<i>Alopias vulpinus</i>	0.096	0.047	0.021	0.004	0.007	-	-	-
<i>Hexanchus griseus</i>	-	0.004	-	-	-	-	-	0.003

#### A4.5.3. Ligurian Sea

Garibaldi & Orsi Relini (2000) present data for the Cetacean Sanctuary of the Ligurian Sea. In the years 1990-1998 the small longline fishing fleet of Sanremo (3-7 vessels targeting swordfish) by-caught *Prionace glauca*, *Alopias vulpinus*, *Isurus oxyrinchus*, *Carcharhinus plumbeus* and *Lamna nasus*. The Blue shark was the main by-catch (Table A4.18). The overall ratio swordfish/blue shark catches was 18,5/1 in number.

Table A4.18. Average weight and CPUE (N/1000 hooks, kg/1000 hooks) of blue shark caught by the Sanremo fleet in the Cetacean Sanctuary of the Ligurian Sea from 1990 to 1998 (Garibaldi and Orsi Relini, 2000).

	1990	1991	1992	1993	1994	1995	1996	1997	1998	Average
Av. weight	12.08	16.6	12.5	13.3	9.28	8.5	9.6	10.4	9.96	11.0
CPUE (N)	0.28	0.52	1.09	0.08	0.18	0.65	0.4	0.2	0.12	0.32
CPUE (kg)	3.38	8.75	13.73	1.12	1.68	5.58	3.74	2.16	1.17	3.58

Other data are available from swordfish longline vessels for the ports of Imperia and Sanremo (Orsi Relini et al., 1999). The survey was carried out at landing (Table A4.19). *Prionace glauca* forms 95% of number caught, the remaining is composed of *Alopias vulpinus*, *Isurus oxyrinchus*, *Lamna nasus* and *Carcharhinus plumbeus*.

Table A4.19. CPUE (kg/1000 hooks) of shark by-catch of swordfish longline registered in Imperia and Sanremo landing points, from 1990 to 1997 (Orsi Relini et al., 1999).

	1990	1991	1992	1993	1994	1995	1996	1997	Average
CPUE (kg/1000 hooks)	1.9	8	7.5	1.4	2.55	5.75	5.25	2.2	4.3

#### A4.5.4. Tyrrhenian Sea and Strait of Sicily

Di Natale (1998) reported the CPUE in number of specimen/km of swordfish longline gear of three by-catch species: *Prionace glauca* = 0.358; *Isurus oxyrinchus* = 0.051; *Sphyrna zygaena* = 0.026. Data were collected by on board observers in 1994-1995. He also shows data from port landings (Table A4.20).

Table A4.20. Number and tons of sharks landed from longline vessels at ports on the Tyrrhenian Sea and the Strait of Sicily, 1994-1995 (Di Natale, 1998).

Shark Species	1994		1995	
	Number	tons (GWT)	Number	tons (GWT)
<i>Alopias vulpinus</i>	9	1	34	4
<i>Prionace glauca</i>	2160	80	3190	157
<i>Lamna nasus</i>	127	5	212	9

#### A4.6. Interview Results

None of the interviewed fishermen are concerned with shark damage to their gear. They estimate the damage caused by the sharks in a typical set is close to zero. They reported that, at the moment, a high amount of shark interactions simply does not occur. When it occurs, the part of the gear that is most often lost to sharks is the end of the branch line with hook and bait. A few branch lines (0 to 10) are lost on a typical set owing to sharks, so fishermen spend a very little time and money replacing gear. Usually none, sometimes only one or two target fishes per set are damaged or lost to sharks. Fishermen say they can recognize shark damage versus other fish, cetacean, or squid damage according to bite characteristics. Almost every time they find a cut branch line, they say that is a consequence of a shark catch. Shark species interacting with longline fishing gear are mostly blue shark (*Prionace glauca*, 0-2 catches per fishing trip), while porbeagle (*Lamna nasus*), shortfin mako (*Isurus oxyrichus*) and smooth-hounds (*Mustelus* sp.) are rare. In their opinion the first most frequently by-caught shark species is the blue shark (*Prionace glauca*), the second is the thresher shark (*Alopias vulpinus*), the third is the porbeagle (*Lamna nasus*). Other occasionally caught species are the shortfin mako (*Isurus oxyrichus*), the hammerheads (*Sphyrna* sp.) and the smooth-hounds (*Mustelus* sp.). Most specimens are alive when hauled to the boat.

All mentioned species are marketable, but meat is sold at a low price (2-5 €/kg). The thresher shark and the porbeagle are easily sold, the blue shark has a low value (and almost all fishermen discard it), the hammerheads in some cases are discarded because of the strong smell. Fishermen discard not marketable sharks, usually by cutting the branch line. The dehooker is largely unknown but, even when this gear is shown, they say it is more simple and safer to cut the branchline. When a shark is marketable, instead, it is hauled, killed by beating and eviscerated. Entrails are discarded and thrown into the water.

Finning has never occurred, and the meat is the only part of shark to be sold. Even the long tail of the thresher shark (*Alopias vulpinus*), that is usually cut for convenience, is discarded.

All interviewed fishermen do not know about shark regulations (e.g. Council Regulation (EC) 1185/2003 forbidding finning) and about protected shark species (e.g. basking shark *Cetorhinus maximus*, CITES Appendix II). Anyway, catching sharks is not a profitable business for fishermen at the moment (as well as in the past). When asked, they say they would like to avoid shark capture without lowering the catch of target species. On the other hand, Italian fishermen are very quick in catching opportunities. If there were substantial shark populations in the Italian waters and a local market for shark fins, probably they would fish for sharks. By now, the revenue from sharks is so low that it does not exceed the cost of catching them. In fishermen's opinion, no regulation changes could affect this trend.

All interviewed fishermen do not use shark catch and depredation avoidance methods, and did not try such methods in the past. When they have a higher shark by-catch rate, they do not change the way they fish (e.g. changing position, time, or bait). Some of them (4) said that 30 years ago they used branch line with a more strong end part (near the hook), in order to reduce the cutting by the shark and capture it. This type of fishing was never done for selling the meat or other parts of a shark, but only to avoid losing the branch line. Fishermen said that they would kill every shark caught to reduce shark abundance, which they believed would increase the swordfish catch rate.

Regarding opinions on the possible efficacy of avoidance methods, some fishermen think it is possible to avoid peak areas and times of shark abundance, and some think it is possible to reduce the detection of baited hooks by refraining from chumming during the set and not discarding offal and spent bait during the haul. In any case, they have never tried these methods, and no one has ever chummed while fishing. Some fishermen point out that the attractiveness of baited hooks to sharks can be reduced using mackerel instead of squid bait. In fishermen's opinion, the most important factor that affects shark catch is the hooks depth, followed by topographic and oceanographic features. Interviewed fishermen are not inclined to use dehookers to release sharks, some actually usually do not haul sharks (even marketable ones) to avoid the risk of handling.

Captains and crew are little interested in reducing shark capture and depredation. They have a very pragmatic attitude towards sharks, with no consciousness of their ecological role. They know sharks are not economically profitable, and they are persuaded that sharks are now rare in the Italian waters

(many fishermen compare actual very low shark by-catch rates with very high rates dating back to more than a decade ago). On the other hand, sharks cause little damage to fishing gear and are dangerous to handle, so fishermen would like to avoid them, if avoidance methods do not lower the catch rate of target species.

#### A4.7. Shark Trade

As Vannuccini (1999) reported to FAO, Italian shark export has ever been of little importance; for example in 2004 recorded values were 199 t and 469,000 \$ (FAO, 2006). No data on the fishing gear used to catch these sharks is available.

On the other hand Italy is one of the leading world importers of sharks (Table A4.21). In 1998 the major supplier to Italy was Spain, followed by Netherlands, United Kingdom, South Africa and France (Vannuccini, 1999).

Porbeagle (*Lamna nasus*), smooth-hounds (*Mustelus* spp.), catsharks (*Scyliorhinus* spp.) and piked dogfish (*Squalus acanthias*) are shown in the list of the most imported species (Vannuccini, 1999).

Table A4.21. Import of shark products in Italy: quantity and values (FAO Fishstat Plus - Commodities production and trade 1976-2004).

		1995	1996	1997	1998	1999	2000	2001	2002	2003	2004
Sharks, fresh or chilled	Quantity (t)	530	453	424	580	614	700	837	709	751	850
	Value (000 \$)	2,841	2,785	2,449	3,116	3,173	3,006	3,628	3,463	4,114	5,070
Sharks, frozen	Quantity (t)	9,584	11,913	11,409	11,475	10,654	10,031	9,736	7,942	6,379	7,213
	Value (000 \$)	26,562	27,687	26,243	23,429	20,719	19,973	19,646	12,381	10,316	14,015
Shark fillets, frozen	Quantity (t)	395	264	266	447	413	373	485	759	603	755
	Value (000 \$)	1,445	1,019	857	1,724	1,305	1,264	1,882	2,650	1,955	2,271

#### A4.8. References

- Commission of the European Communities, 2003. Report of Ad Working Group - Elasmobranchs Fisheries. Commission Staff Working Paper SEC(2003)1427.
- Commission Regulation (EC) No 2091/1998 of 30 September 1998. Segmentation of the Community fishing fleet and fishing effort in relation to the multi-annual guidance programmes (MAPG) - Annex I.
- Commission Regulation (EC) No 26/2004 of 30 December 2003. On the Community fishing fleet register.
- Council Regulation (EC) No 1626/1994 of 27 June 1994. Laying down certain technical measures for the conservation of fishery resources in the Mediterranean.
- Council Regulation (EC) No 1185/2003 of 26 June 2003. On the removal of fins of sharks on board vessels.
- De Metrio G., Cacucci M., Deflorio M., Desantis S., Santamaria N., 2000. Incidence of the large pelagic fishing on the shark catches. *Biol. Mar. Medit.*, 7 (1): 334-345.
- De Metrio G., Petrosino G., Montanaro C., Matarrese A., Lenti M., Cecere E., 1984. Survey on summer-autumn population of *Prionace glauca* L. (Pisces, Chondrichthyes) in the Gulf of Taranto (Italy) during the four year period 1978-1981 and its incidence on sword-fish (*Xiphias gladius* L.) and albacore (*Thunnus alalunga* (Bonn.)) fishing. *Oebalia*, Vol. X, N.S.: 105-116.
- De Metrio G., Petrosino G., Tursi A., Chieppa M., 1982a. Andamento della pesca di *Prionace glauca* L. nel biennio 1979-1980 al largo delle coste ioniche del Salento (Pisces, Chondrichthyes). *Naturalista sicil.*, S. IV, VI (Suppl.), 2: 413-419.
- De Metrio G., Petrosino G., Tursi A., Francioso E., 1982b. Comparazione chimica, aminoacidica ed elettroforetica delle carni di *Mustelus mustelus* L. e di *Prionace glauca* L. (Nota preliminare). *Atti Società Italiana delle Scienze Veterinarie*, 35: 646-647.

- De Zio V., Pastorelli A.M., Rositani L., 2000. By catch of blue shark *Prionace glauca* (L.) during large pelagic fishery in southern Adriatic Sea (1984-1998). *Biol. Mar. Medit.*, 7 (1): 444-446.
- Di Natale A., 1998. By-catch of shark species in surface gear used by the Italian fleet for large pelagic species. *Col. Vol. Sci. Pap. ICCAT*, 48 (3): 138-140.
- FAO Fishstat Plus: Universal software for fishery statistical time series. Version 2.31. Datasets: GFCM Capture Production 1970-2004; Commodities production and trade 1976-2004. Food and Agriculture Organization of the United Nations, Fisheries Department, Fishery Information, Data and Statistics Unit. ([www.fao.org/fi/statist/FISOFT/FISHPLUS.asp](http://www.fao.org/fi/statist/FISOFT/FISHPLUS.asp)).
- Ferretti M., Tarulli E., Palladino S. (Eds.), 2002. Classificazione e descrizione degli attrezzi da pesca in uso nelle marinerie italiane con particolare riferimento al loro impatto ambientale. Quaderno ICRAM n° 3, Roma, 126 pp.
- Filanti T., Megalofonou P., Petrosino G., De Metrio G., 1986. Incidenza dei Selaci nella pesca del pesce spada con long-line nel Golfo di Taranto. *Nova Thalassia*, 8, Suppl. 3: 667-669.
- Garibaldi F., Orsi Relini L., 2000. Summer abundance, size and feeding habits of the blue shark, *Prionace glauca*, in the pelagic sanctuary of the Ligurian Sea. *Biol. Mar. Medit.*, 7 (1): 324-333.
- Guglielmi P., Di Natale A., Pelusi P., 2000. Effetti della pesca con il palangaro derivante sui grandi pelagici e sulle specie accessorie nel Mediterraneo centrale. Rapporto al Ministero per le Politiche Agricole e Forestali, DGPA, Roma. Unpublished report.
- IREPA, 2006. Osservatorio economico sulle strutture produttive della pesca marittima in Italia 2004. Franco Angeli, Milano, 294 pp.
- ISTAT, 2004. Dati annuali sulla pesca. ISTAT Servizio Agricoltura, Allevamenti e Pesca, Roma.
- ISTAT, 2006. Principali risultati sull'attività di pesca anno 2004. ISTAT Servizio Agricoltura, Allevamenti e Pesca, Roma.
- IUCN Shark Specialist Group Red List assessments, 2000-2006 (last updated May 2006).
- Marano G., Rositani L., Ungaro N., De Zio V., 1988. Cours des prises avec palangre de surface dan l'Adriatique du sud (cotes italiennes), triennat 1984-86. *Fao Fish. Rep.* 394: 112-120.
- Megalofonou P., Yannopoulos C., Damalas D., De Metrio G., Deflorio M., de la Serna J.M., Macias D., 2005. Incidental catch and estimated discards of pelagic sharks from the swordfish and tuna fisheries in the Mediterranean Sea. *Fish. Bull.*, 103 (4): 620-634.
- Megalofonou P., Damalas D., Yannopoulos C., De Metrio G., Deflorio M., de la Serna J.M., Macias D., 2000. By-catches and discards of sharks in the large pelagic fisheries in the Mediterranean Sea. European Union Project 97/50 Directorate General XIV/C1, 336 pp.
- Ministerial Decree 26 July 1995. Disciplina del rilascio delle licenze di pesca. Ministero delle Risorse Agricole, Alimentari e Forestali, Roma.
- Ministerial Decree 14 September 1999. Disciplina della piccola pesca. Ministero delle Risorse Agricole, Alimentari e Forestali, Roma.
- Orsi Relini L., 2000. Longline fisheries, blue shark catches and conservation problems. *Biol. Mar. Medit.*, 7 (1): 313-323.
- Orsi Relini L., Palandri G., Garibaldi F., Cima C., 1999. Longline swordfish fishery in the Ligurian Sea: eight years of observations on target and by-catch species. *Col. Vol. Sci. Pap. ICCAT*, 49 (1): 146-150.
- UNIMAR, 2001. Gli attrezzi da pesca in uso nelle Marinerie Italiane - Primi risultati del programma MAPP. Consorzio Unimar, Roma, 16 pp.
- Vacchi M., Notarbartolo di Sciara G., 2000. The cartilaginous fishes in Italian Seas, a resource that urges to be protected. *Biol. Mar. Medit.*, 7 (1): 296-311.
- Vannuccini, S., 1999. Shark Utilization, Marketing and Trade. FAO Fisheries Technical Paper, Rome.

## Appendix 5

### Japan Pelagic Longline Fisheries: Industry Practices and Attitudes towards Shark Depredation and Bycatch

Shelley Clarke, [scclarke@biznetvigator.com](mailto:scclarke@biznetvigator.com)

#### A5.1. Introduction and Methods

This description of the shark depredation and bycatch situation in Japanese longline fisheries is based on interviews, catch records held by the National Research Institute for Far Seas Fisheries (Japan Fisheries Research Agency), and other published information as cited. The Organization for Promotion of Responsible Tuna Fisheries (OPRT), the Global Guardian Trust (GGT) and the National Research Institute of Far Seas Fisheries (NRIFSF) provided essential assistance in data access and compilation.

The interviews were conducted from April-July 2006 in the ports of Kesennuma in Miyagi prefecture (15 interviews), Kii-Katsuura in Wakayama prefecture (8 interviews), Yaizu in Shizuoka prefecture (2 interviews) and Misaki in Kanagawa prefecture (1 interview) by Shelley Clarke of NRIFSF (all interviews), Toshikazu Miyamoto of GGT (Kesennuma and Kii-Katsuura) and Ziro Suzuki of NRIFSF (Yaizu and Misaki) (Fig. A5.1).



Fig. A5.1. Map of Japan showing the location of the four interview ports.

These ports were chosen from a subset of Japanese ports with high numbers of registered longline vessels and substantial catches of large pelagic fishes (Table A5.1), and because it was possible to arrange interviews in these areas during the timeframe of the study (see below).

In addition to aiming to conduct interviews across a range of ports and areas, a variety of different longline vessel types were targeted. Longline vessels in Japan are divided into three classes:

- *Enyo* (遠洋), or distant water, vessels are >120 metric tonnes (mt), have crews of 15-20, are at sea for periods of two to three months, and range throughout the world's oceans.

- *Kinkai* (近海), or offshore, fishing vessels are 10-120 mt, have crews of less than ten, and are at sea for periods ranging from one week to one month in fishing grounds generally west of 180° longitude.
- *Engan*<sup>1</sup> (沿岸), or nearshore, vessels are less than 10mt, with as few as one fisherman onboard making trips of 1-7 days.

Table A5.1. Japanese prefectures ranked by the total number of tuna longline vessels registered in 2003. Vessels are shown by class and in total, along with the total catch of tunas, billfishes and sharks in 2003. Prefectures where interviews were conducted are shaded. (MAFF, 2005 (most recent data=2003)).

Prefecture	Number of Longline Vessels (#)				Total Catch of Tuna, Billfish and Sharks (mt)
	Enyo	Kinkai	Engan	Total	
Miyazaki	27	85	88	200	24,723
Okinawa	1	77	86	164	10,251
Miyagi (including Kesenuma)	112	36	10	158	57,200
Kochi	46	74	27	147	26,321
Hokkaido	28	3	99	130	11,316
Kagoshima	72	2	1	75	26,094
Mie	18	22	24	64	22,022
Tokyo	21	1	39	61	10,814
Oita	2	57	2	61	9,039
Chiba	2	2	55	59	912
Wakayama (including Kii-Katsuura)	8	17	23	48	4,217
Iwate	28	4	11	43	12,911
Shizuoka (including Yaizu)	40			40	26,736
Kanagawa (including Misaki)	27	3		30	11,988
Tokushima	1	11	14	26	2,080

Since *enyo* vessels may be absent from Japan for periods of 6-9 months (i.e. they are reprovisioned in foreign ports), they are only infrequently in their home ports and are difficult to contact. For this reason other major longline ports with a high proportion of *enyo* vessels, e.g. Nichinan in Miyazaki prefecture on Kyushu and Kochi in Kochi prefecture on Shikoku, could not be included in the interview program.

A total of 26 interviews were conducted with active or retired fishermen and fishery officials. In Kesenuma, 7 active vessel captains (6 *kinkai* and 1 *engan*), 3 retired fishing masters (all *kinkai*), 2 fishing company owners, 2 fisheries cooperative representatives and 1 port official participated in the interview program. In Kii-Katsuura, 1 *kinkai* captain was interviewed, but the remaining 6 fishermen interviews were with the captains of *engan* vessels, the majority of which fished alone (i.e. without crew). A visit to a local shark products factory provided supplemental information. As Yaizu and Misaki are predominantly home ports for *enyo* vessels, opportunities for interviews were limited to retired fishermen now working as managers in fishing companies. In Yaizu, one retired captain and one retired engineer were interviewed, and in Misaki, one retired captain was interviewed. An interview with a representative of the Japan Tuna Fisheries Co-operative Association in Tokyo provided supplemental information on *enyo* operations. All interviewed fishermen had been fishing for over 20 years and most had experience with a range of gear types and species targets.

<sup>1</sup> *Engan* vessels may also be referred to as *kogata* (小型), or small-size, vessels. The terms can be used interchangeably.

## A5.2. Historical Fleet Development, Shark Catches and Gear Configurations

Japan has maintained a significant longlining presence in the Pacific for many decades. Motorization of longline vessels began around 1912 and by 1925, 90% of the fleet was motorized. By 1929 the number of such vessels approached 2,000. This development of the longline fleet is reflected in the catch trends for sharks over the last century (Fig. A5.2). With the technological advancement of motorization in the 1920s the shark catch grew rapidly from previous levels of approximately 10,000 tonnes per annum to levels of 60,000-70,000 tonnes per annum just prior to and during the Second World War (WWII) (Okamoto 2004).

Catches collapsed at the end of WWII with implementation of the Potsdam Treaty of August 1945. This treaty initially proscribed all Japanese fishing activity but was quickly changed to allow fishing within 12 nautical miles of the coast. Progressive extension of the outer limit of the fishing grounds accessible to Japan, known as the “MacArthur Line”, occurred over the following few years (1946-1949) and paralleled rapid increases in shark catches. During this period, despite the lack of refrigeration facilities onboard vessels, shark meat was commonly used for food and the demand for shark fins in China supported a valuable export trade. The value of shark products, even in the early days of the fishery, is responsible for the existence of statistics on shark catches over such a long time series (Okamoto 2004).

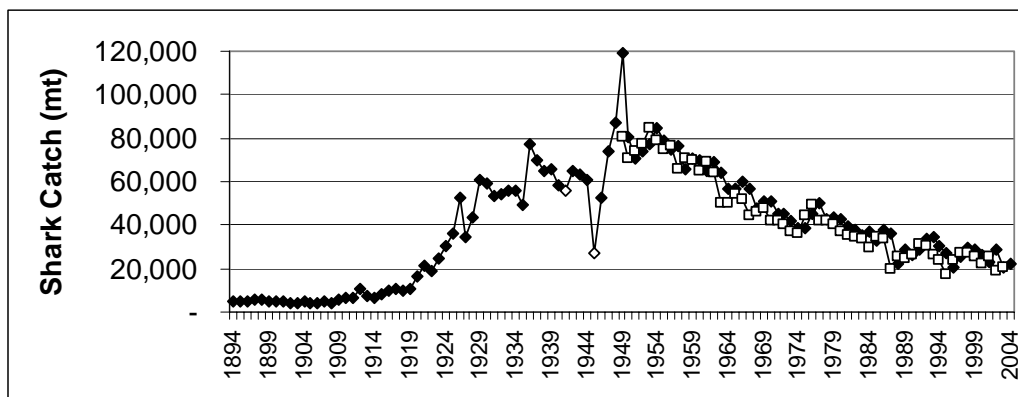

Fig. A5.2. Shark catch (in mt) by Japan, 1894-2004. Data from 1894-1949 (◆), when Japan's fishing activities were limited to the Pacific, were sourced from Okamoto (2004). Data from 1950-2004 (◊) are Japan's catches for all oceans and subset, to the maximum extent practical, to exclude non-shark elasmobranchs (FAO 2006). Japan's reported catches for the Pacific (only) are denoted with ◻ (FAO 2006). The beginning (1941) and ending (1945) of WWII are shown with open circles (○).

In April 1952 the MacArthur Line restrictions were completely lifted, allowing for the full-scale launch of Japan's far seas tuna longline fishery. The sharp decline in shark catches from a peak of 120,000 mt in 1949 to below 80,000 mt in 1952 is linked to this expansion of offshore operations for two reasons. First, many of the longline vessels which had previously been targeting sharks off northern Japan converted to more valuable distant water tuna fishing operations, thus the shark-directed fishery effort was reduced. Second, sharks caught by distant water operations targeting tuna were not retained because of a desire to maximize hold space availability for tuna (Okamoto 2004), thus the shark handling practices changed.

During the Japanese longline fishing ground expansions of 1960s through 1980s (see Myers and Worm (2003) for maps), reported shark catches continued to fall (Fig. A5.2). Nevertheless, the proportion of reported shark catch deriving from the Pacific was maintained at a disproportionately high level. While longline effort in each ocean since 1960 shows that Pacific effort was no more 77%, and sometimes as little as 47% of total effort in each year (Fig. A5.3), the ratio of Pacific to non-Pacific shark catches averaged 0.94 from 1950-2004 and never dropped below 0.86 in any year (Fig. A5.2).

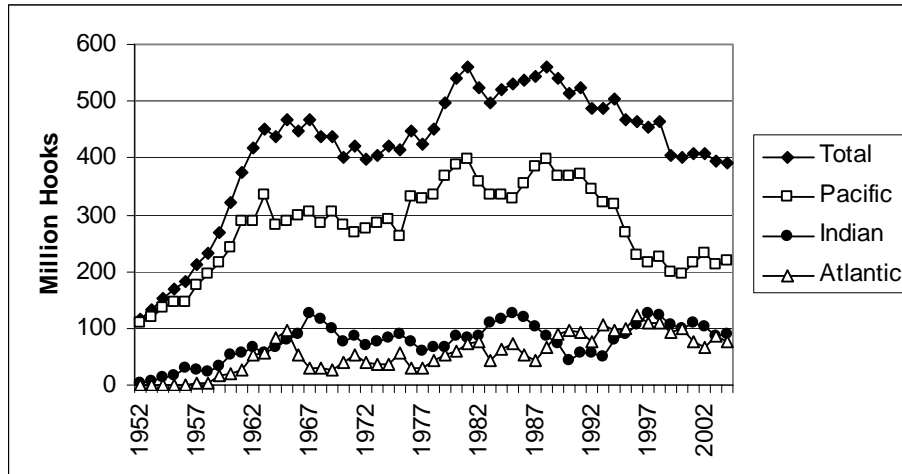

Fig. A5.3. Japanese tuna longline effort by ocean, 1952-2004. (Suisan Sougou Kenkyuu Center, 2006).

At the end of the 1960s the development of flash freezing and super-cold (minimum  $-40^{\circ}\text{C}$ ) storage facilities led to a shift in tuna species targeted by the longline fishery away from albacore and yellowfin for canning, toward bluefin and bigeye for sashimi (Miyake et al. 2004). As a result, in the early 1970s, small- and medium-sized Japanese vessels in the western and central Pacific began to favor deep setting of hooks to better target bigeye tuna (*Thunnus obesus*). In contrast to the standard (or shallow) sets in which hooks would extend to a maximum depth of 120m, the new form of deep setting placed hooks initially as deep as 250m and as time went by even deeper depths were fished. By the mid 1980s over 80% of all sets by the Japan fleet were deep sets (Suzuki et al. 1977).



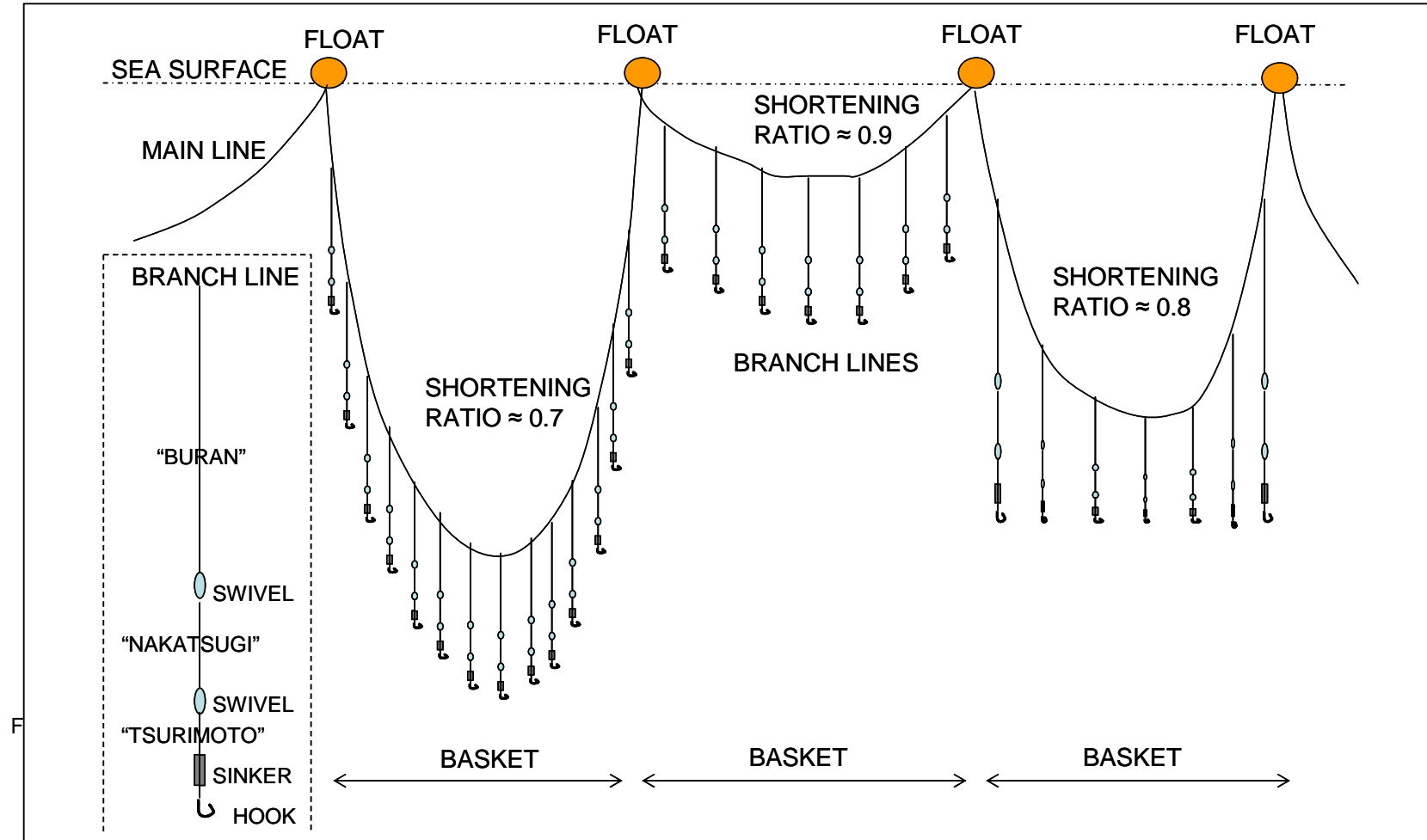

Fig. A5.4 illustrates the components of longline gear and several generic configurations that have been used over the years. Although hook depth is very important in characterizing types of longline fishing operations, hook depth is not recorded in logbooks and for various reasons may not always be well understood<sup>2</sup>. Instead the number of branch lines between floats (also called hooks per basket or hpb) is often used as a proxy. However, as shown in Fig. A5.4, the depth of the hook is not necessarily related to the hpb, i.e. a shallow set may have few or many hpb. Instead, the shortening ratio, or the ratio of sea surface distance between floats to the length of the main line between floats may be a more accurate, though usually unavailable, descriptor of longline configuration.

In the 1960s the shortening ratio was 0.65-0.7 indicating that the catenary curve between floats had a steep slope and the range of hook depths was quite broad. This may have been because fishermen's knowledge of target species' depth was not very precise and setting hooks over a broad depth range increased the chance of "hitting" the appropriate depth. When targeting of bigeye tuna began in the 1970s, fishermen observed that 2 or 3 bigeye could be caught on consecutive branch lines, often twice within a single basket at the same depth, i.e. along the descent and ascent of the main line's catenary curve. Once tuna's depth preferences were better understood, the objective was thus to place all of the hooks at the same depth using a higher shortening ratio (e.g. 0.8). In the early 1990s technological advances suddenly allowed the use of monofilament as a material in longlines. Because monofilament was lighter than other materials, the shortening ratio became even higher (0.9) as the length of the mainline approached the sea surface and fishermen were able to hang more and more branch lines off the strong but light monofilament. However, at the same time, it appeared that the schools of bigeye began to disaggregate and fishermen returned to a system of placing the hooks at a range of depths by varying the length of the branch line rather than changing the high shortening ratio. In recent years, some Japanese longline fishermen have begun reverting to heavier and stiffer main lines with lower (i.e. deeper) shortening ratios. The reason for this is unclear but may be connected to a desire to target larger and deeper-swimming bigeye, to avoid tangling of the main line, or to vary the fishing strategy from other longline fleets who have learned from the Japanese longline fisheries' past example.

Today's longline operations consist of a variety of configurations based on different numbers of hpb, shortening ratios, branch and main line lengths and materials. It is thus difficult to characterize the different gear types into generic categories. As an example of materials used, longline leaders used to target tuna or billfish may consist of a *buran* of rope or cord, followed by a *nakatsugi* of 3mm nylon monofilament, and an upper *tsurimoto* of stiff cord with another length of nylon monofilament connecting the cord to the hook (Fig. A5.4). If the fishermen wish to minimize sharks biting off the hook, they may cover the lower length of nylon monofilament with a steel sheath but this may cause the bait to move in the water column in an unnatural manner and thus may result in a lower catch rate for tuna. Fishermen who are even more focused on catching sharks may use a cord *buran*, followed by a 2mm monofilament *nakatsugi*, and a *tsurimoto* of 1mm braided steel wire. Such types of gear are favored by shark fishermen because they attract sharks yet are resilient to shark bite-offs. They have the added advantage of manpower savings in that, unlike monofilament *tsurimoto*, they do not need to be checked for damage between each deployment. Main lines may be made of rope (e.g. Kesenuma) or nylon monofilament (e.g. Kii-Katsuura).

### A5.3. Current Fleet Characteristics and Shark Catches

As described in the previous section, the Japanese longline fishery has a long history and has undergone a number of major innovations. Despite these general trends, longline operations remain highly diverse and vary considerably by region and fishing master. The following sections attempt to characterize the current state of the Japanese longline fishery in terms of vessel numbers, effort and catch, highlighting important distinctions where relevant.

<sup>2</sup> There are many reasons (e.g. current speed, line setting method, etc.) why the intended fishing depth of the hook is not realized. Please see Shiode et al. (2005) and Miyamoto et al. (2006) for more information.

### A5.3.1. Number of vessels by size class

The number of vessels registered in each size class is shown in Table A5.2. By 2003, the *enyo* fleet had contracted to 66% of its size in 1993. This reduction is partially attributable to a Japanese government buy-back program implemented in 1999 in response to the FAO International Plan of Action for the Management of Fishing Capacity (IPOA-Capacity) which scrapped 132 tuna longline vessels (FAO 2004). Further reductions in the number of longline vessels are expected in 2006 due to adverse economic conditions resulting from high oil prices, declining catches, competition from farmed tuna and the elimination of government-sponsored financing services (Japan Times 2006). It should be noted that vessel statistics for 2002-2003 show an apparent increase in small-class *kinkai* vessels but upon closer inspection this increase results merely from a reclassification of large-class *engan* vessels and does not halt the overall trend of decline in vessel numbers (Table A5.2, Total column). This trend is also reflected in the finding by Miyake et al. (2004) that Japan's share of the global tuna catch relative to other countries has declined over time.

Table A5.2. Number of vessels by size class, 1993-2003. (MAFF, 2005 (most recent data=2003)).

	<i>Total</i>	<i>Engan</i>			<i>Kinkai</i>		<i>Enyo</i>	
		<5 mt	5-10 t	> 10 t	<=50 mt	>50 mt	<=200 mt	>200 mt
1993	1,829	131	181	478	18	254	85	682
1994	1,823	147	187	485	21	234	75	674
1995	1,704	87	179	472	20	202	78	666
1996	1,614	104	154	453	17	183	63	640
1997	1,573	105	158	435	11	169	64	631
1998	1,555	100	165	447	11	153	56	623
1999	1,473	103	160	440	6	146	51	567
2000	1,418	126	165	441	3	142	45	496
2001	1,461	142	197	438	4	141	45	494
2002	1,447	144	198	144	298	135	44	484
2003	1,390	128	198	154	287	119	44	460

According to interview information, all of the *enyo* longliners are equipped with ultra-low temperature (ULT) freezers. Refrigeration in the *kinkai* fleet is sometimes in the form of freezers; in other vessels ice is used. Some of the *engan* fleet use a well of chilled water rather than ice. When asked to compare the level of freezer technology in the Japanese *enyo* fleet to that of other fishing entities, a knowledgeable source stated that rapid development of other fleets is quickly closing any remaining technology gap.

### A5.3.2. Catch and effort by vessel class and operational behavior

Longlining operations represent Japan's primary fisheries for tuna and billfishes. In addition, in the period between 1993 and 2003, longline gear has consistently been responsible for 70-80% of Japan's annual reported shark catch (MAFF, 2005). In contrast to shark catches which are generally higher in the latter half of this time period for all vessel classes (Fig. A5.4a), total longline catches of all species show a gradually declining trend (Fig. A5.4b). In terms of sharks, *kinkai* vessels contribute the largest portion of the catch, followed closely by *enyo* vessels (Fig. A5.4a). In terms of total catch, however, *kinkai* catches comprise only 20 to 40% of the catch volume of *enyo* vessels (Fig. A5.4b). Therefore, *kinkai* vessels are either hooking a disproportionately large share of sharks due to some aspect of their operational behavior, or merely retaining a greater proportion of hooked sharks.

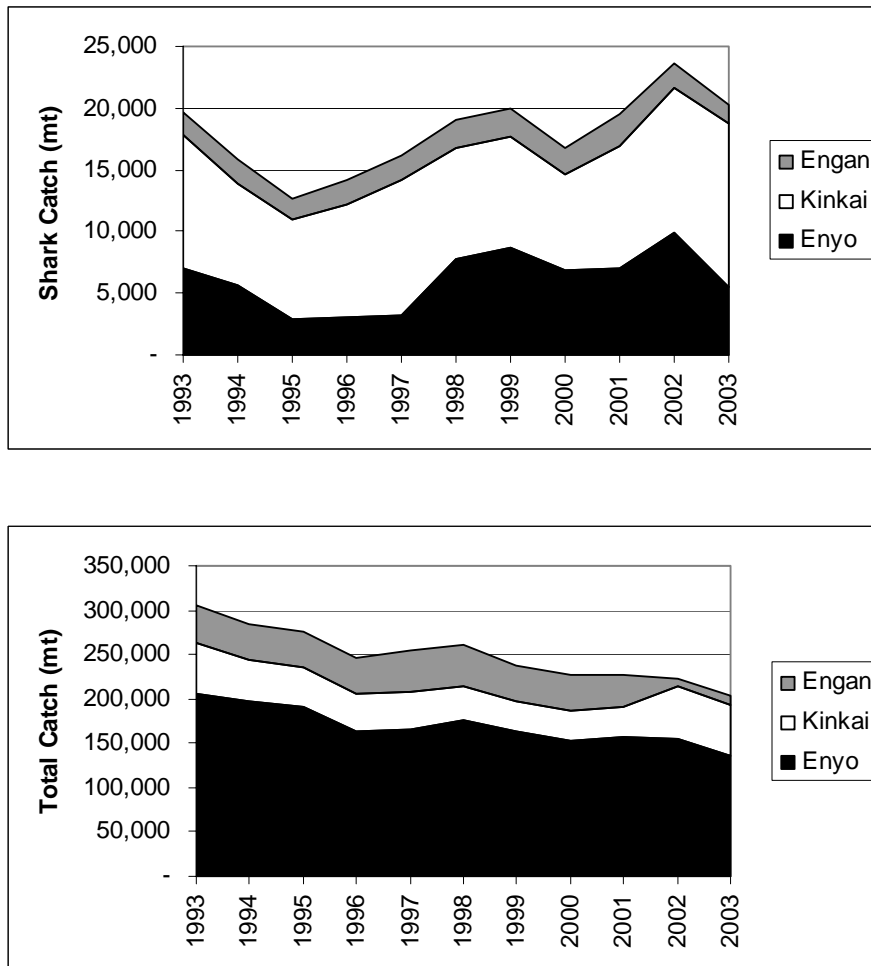

Fig. A5.5. Recorded shark catch and total catch (i.e. all species) by vessel class in the Japanese longline fleet, 1993-2003. (MAFF, 2005 (most recent data=2003)).

One possibly important factor influencing shark catch rates is hook depth. An early study comparing catch rates between shallow and deep sets observed higher catch rates in the deep sets for bigeye tuna but did not investigate differences in shark catch rates (Suzuki et al. 1977). With the some notable exceptions, e.g. bigeye thresher sharks (*Alopias superciliosus*, Nakano et al. 2003), the depth preferences of most shark species are not well understood, and thus it is difficult to predict the potential effect of deeper hook setting on shark species. In particular, for species such as blue shark (*Prionace glauca*), which are believed to be widely distributed in the water column (Nakano and Seki 2003), hook depth may not have a major effect on catch rates.

Despite this theory, analysis of shark catch rates between longline sets in the North Pacific characterized as shallow (4-6 hpb) and deep (7-20 hpb) showed a striking pattern. In a recent analysis, an analytical filter was applied to remove data from fishermen who do not always accurately record shark catches (Nakano and Clarke 2006). The filter works by assuming that at least 80% of all sets in a single cruise should record at least one shark and excludes data from cruises which do not meet this criterion. In other words, the number of sets in a cruise passing the filter can be used as a rough indication of the frequency of shark catches and when the frequency is too low the reporting is suspect. When the effect of the filter was examined separately for shallow and deep sets, the percentage of shallow sets passing the filter remained consistently above 25% from 1971-1985 and from 1985 until 2002 more than 90% of the shallow sets passed the filter (Fig. A5.6). In contrast, during the same

period (1971-2002) the proportion of deep sets passing the filter ranged from 7-26%. These data seem to suggest that the depth of the set may determine the shark catch rate.

However, when the location of shallow and deep sets was examined it was revealed that proximity to Japanese ports is confounded with hooks per basket (a proxy variable for depth). Therefore, it may be location and not depth which is responsible for the observed trends. In particular, as the fishery developed (see Section A5.2) the location of the deep sets moved farther and farther offshore, coincident with the expansion of the *enyo* fleet's targeting of bigeye tuna. Within the small subset of the deep sets that remained in nearshore waters (i.e. waters between 15-40°N and 140-160°E) a high percentage (80%) passed the filter (i.e. frequently recorded at least one shark per set) between 1971-1992<sup>3</sup>. The shallow sets, which had a high rate of passing the filter were predominantly made in inshore waters (15-50°N and east of 180°E) which are the fishing grounds of the *kinkai* fleet. This finding reinforces and partially explains the finding of disproportionately high shark catches in the *kinkai* fleet. Given the available data, we cannot determine whether there is causality between the higher *kinkai* shark catch rates and a) the proximity to a market for sharks in Japanese ports and/or b) the effect of setting hooks at shallow depths.

Fig. A5.6 indicates that a very high proportion of shallow sets record catching sharks, whereas a very low proportion of deep sets record catching sharks (Source: NRIFSF unpublished data).

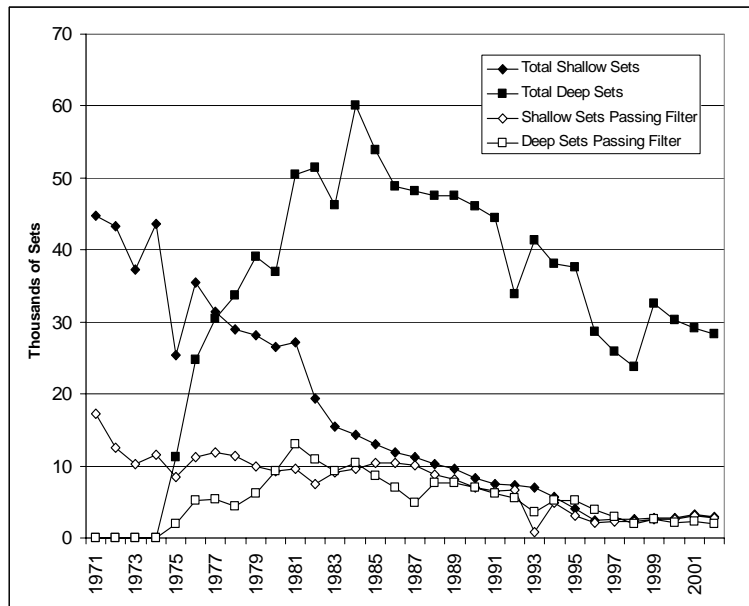

Fig. A5.6. The effect of filtering Japanese longline fishery logbooks, 1971-2002, using a reporting rate of 80% (i.e. discarding records from vessels which did not report shark catches for at least 80% of all sets in a single cruise).

### A5.3.3. Calculation of nominal shark CPUE

Effort for the three longline fleets are currently published (MAFF 2005) in units of cruises for *enyo* and *kinkai* fleets, and days at sea for the *engan* fleet (Table A5.3, Columns 1-3). In previous years (e.g. MAFF 2003), effort for the *enyo* and *kinkai* fleets was published in units of sets (Table A5.3, Columns 4-5). If one assumes that each *engan* day at sea represents one set of on average 1,000 hooks, and each *kinkai* and *enyo* set represents on average 2,000 hooks, an approximate number of hooks fished by each fleet can be calculated (Table A5.3, Columns 6-8) thereby providing a common unit of effort for all three fleets.

<sup>3</sup> For an unknown reason, in 1993 the percentage of deep sets in nearshore waters which pass the filter drops suddenly below 20% and remains at this low level until 2002. While it may be possible that deep set longline operations changed abruptly in 1993, it is also possible that the introduction of new logbook reporting formats in 1993 may also be a factor.

Combining the effort data in Table A5.3 with the annual shark catch data in Fig. A5.5a (i.e. year-by-year, fleet-specific shark catch divided by effort) produces nominal catch per unit effort (CPUE) figures for sharks over the years 1993-2003. The *engan* and *enyo* fleets have a similar nominal shark CPUE of 0.020 (sd=0.0022) for *engan*, and 0.021 (sd=0.0090) for *enyo*. The nominal shark CPUE in the *kinkai* fleet, 0.175 (sd=0.0339), is higher by a factor of 8. Some of the potential reasons for this higher CPUE in the *kinkai* fleet have been explored in the previous section. Further information on the operational behavior of the *kinkai* fleet based on interviews with fishermen is presented in Section A5.5.2.

Table A5.3. Effort by vessel class, 1993-2003.

	Source: MAFF (2005)			Source: MAFF (2003)		Calculated (see text for assumptions)		
	<i>Engan</i> (days at sea)	<i>Kinkai</i> (cruises)	<i>Enyo</i> (cruises)	<i>Kinkai</i> (sets)	<i>Enyo</i> (sets)	<i>Engan</i> (hooks)	<i>Kinkai</i> (hooks)	<i>Enyo</i> (hooks)
1993	104,173	1,600	2,041	37,426	154,106	104,173	74,852	308,212
1994	103,538	1,712	2,127	31,785	148,725	103,538	63,570	297,450
1995	101,658	1,435	2,009	28,113	141,744	101,658	56,226	283,488
1996	102,087	1,322	2,026	29,163	146,440	102,087	58,326	292,880
1997	108,097	1,233	1,961	25,396	148,716	108,097	50,792	297,432
1998	105,496	1,173	1,712	22,898	143,208	105,496	45,796	286,416
1999	107,304	1,092	1,423	22,973	127,200	107,304	45,946	254,400
2000	109,088	1,066	1,252	23,228	119,677	109,088	46,456	239,354
2001	110,638	1,036	1,220	22,161	124,614	110,638	44,322	249,228
2002	43,056	4,528	1,148	na	na	43,056	na	na
2003	46,403	4,443	1,045	na	na	46,403	na	na

#### A5.3.4. Species composition of shark catches in longline fleets

Prior to 1993, information on shark catches was recorded in logbooks under a single general category ("shark"). Catches recorded in this category were expected to include both pelagic sharks as well as small coastal sharks such as dogfish (Okamoto 2004). A change in logbook recording forms in 1993 (fully implemented as of 1994) provided for separate entries of catches for blue, shortfin mako (*Isurus oxyrinchus*), porbeagle/salmon sharks (*Lamna* spp.) and "other" sharks. Information on species composition since 1993 indicates that the majority ( $\geq 70\%$ ) of the recorded shark catch is blue shark (Fig. A5.7). This fact has led to the development of statistical methods to partition aggregated shark catches prior to 1993 into species-specific catch rate series for the purposes of stock assessment analysis (Nakano and Clarke 2006). The results of these assessments for the sharks shown in Fig. A5.7 are 'stable' for blue sharks, 'possibly in need of conservation or management' for shortfin mako, and 'continued monitoring but no current need for management' for porbeagle/salmon sharks (Suisan Sougou Kenkyuu Center, 2006).

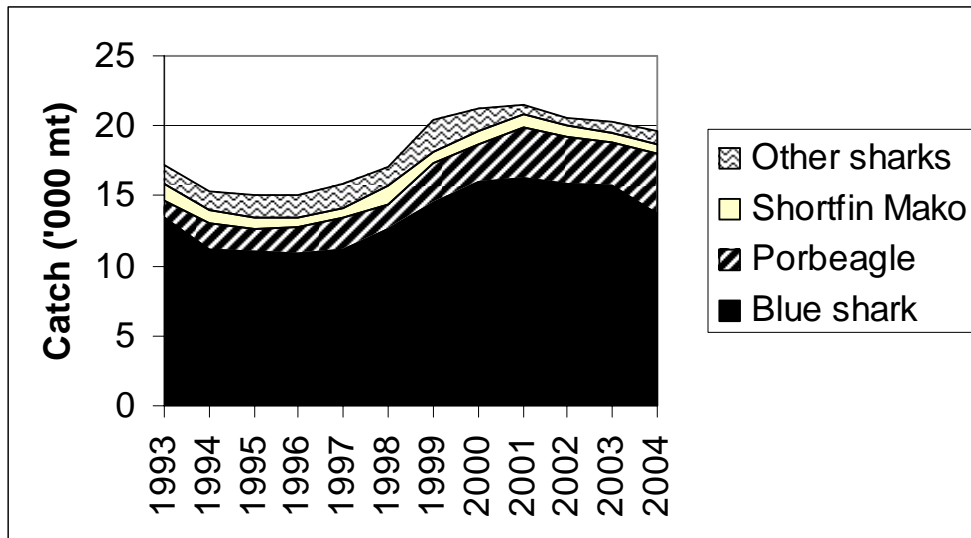

Fig. A5.7. Catch of sharks by species in the tuna longline fishery in the four recording categories used since 1993 (Suisan Sougou Kenkyuu Center 2006).

In 1997, three other categories of sharks, oceanic whitetip (*Carcharhinus longimanus*), silky (*Carcharhinus falciformis*) and threshers (*Alopias* spp.), were added to the longline logbook format. The time series available for these species is very short but preliminary assessments suggest flat trends in catch per unit effort for silky and thresher sharks and slight declining trends for oceanic whitetip sharks. Global catches by Japanese fleets are estimated in the range of 2-13 mt per year for oceanic whitetips, 0-11 mt for silky sharks and 252-596 mt for thresher sharks (Suisan Sougou Kenkyuu Center 2006).

#### A5.4. Management Framework Relevant to Shark Interactions

With regard to enyo and kinkai vessels fishing in international waters, the main applicable management measures for sharks are resolutions or recommendations by regional fisheries management organizations (RFMOs), which discourage finning and encourage full utilization of sharks (Clarke et al. 2006). In addition, some provisions of national finning regulations may indirectly affect operations in international waters. For example, prohibitions on landing shark fins without carcasses in U.S. Pacific territories could, in theory, affect Japanese fishing operations in international waters in the Pacific. Furthermore, any Japanese longline operations in the waters of another country would be required to comply with shark regulations imposed by that country. An example of such regulations would be prohibitions on shark finning in, e.g. South Africa, Brazil, and Costa Rica.

In nations where they exist, finning regulations only govern shark utilization and do not limit total catches. Although concerns about overfishing of sharks are widely recognized, catch limits are rare. This is due, in many cases, to the lack of species-specific information necessary to understand the current state of stocks and select desirable fisheries management reference points. In such cases, shark management discussions often default to calls for a general reduction in fishing effort. In this respect, the size of Japan's enyo and large class kinkai longline fisheries has contracted over time, in part due to actions by government intended to reduce capacity in accordance with the FAO IPOA-Capacity. But due to increasing effort by fleets from other flag states, fishing pressure on pelagic shark stocks is likely to have intensified over time. To support conservation and management of pelagic fishes, Japan contributes data derived from commercial logbooks, as well as results from oceanic research cruises conducted over several decades, to workshops convened by RFMOs and other bodies. Catch and effort trends in Japanese-held databases are summarized annually in published volumes (e.g. Suisan Sougou Kenkyuu Center, 2006).

With regard to Japan's *kinkai* and *engan* vessels fishing in national waters, there are no regulatory controls on catch number, effort or utilization, however, *enyo*, *kinkai* and some *engan* vessels are required to record the number of sharks caught in government-submitted logbooks (see preceding section). Recently, a system for monitoring shark resources in national waters was established in accordance with Japan's National Plan of Action for the Conservation and Management of Sharks (NPOA), prepared in response to the FAO's International Plan of Action (IPOA)-Sharks. Under this system a committee is tasked with recommending shark conservation and management measures to the Japan Fisheries Agency. Since many fisheries in Japan are controlled by central and prefectural governments through license or approval systems, and entries into fisheries are restricted, fisheries managers believe it is not likely that catch pressures on shark resources in domestic waters will change substantially. Therefore, the current policy holds that there is no recognized need to introduce regulatory measures limiting shark catches in domestic waters (Government of Japan, 2001). In general, the philosophy underpinning the Japan NPOA is one of encouraging fishermen to voluntarily seek solutions to bycatch issues. This approach is believed to provide the most efficient and ultimately most effective outcome given that bycatch varies according to operational factors which are only thoroughly understood by fishermen themselves. In this regard, Japan encourages full utilization of shark resources, but based on currently available shark CPUE trends, does not actively advocate shark bycatch reduction to fishermen.

Given the dearth of catch, effort or utilization regulations applicable to Japanese longline fleets, and the absence of any data on compliance, the economic, social and ecological effects of the various prohibitions on, and policies against, shark finning cannot be rigorously evaluated here. However, some relevant, though anecdotal, information from the interview program is presented in the following sections.

## **A5.5. Shark Handling and Disposition Practices by Fleet**

Shark handling and final disposition varies with targeting strategy of the vessel, and may also change with season, number of days at sea, recent catch history, and other factors. The following discussion is organized by fleet (*enyo*, *kinkai* and *engan*) but there is some overlap in shark handling and disposition strategies between fleets, as well as important differences within fleets.

### **A5.5.1. Enyo fleet handling and disposition**

The interviewed *enyo* fishermen and fishery organization representatives (n=5) explained that in previous decades all shark species, other than shortfin mako sharks, were finned and the carcasses were discarded. Because of the value of their meat shortfin mako carcasses were always retained whole and transported back to Japan. According to the respondents, the other species' carcasses were not retained because there were no markets for shark meat other than Kesenuma (Japan) and these vessels did not operate out of Kesenuma.

In recent years, though, markets for shark meat from all species have developed in some areas. Interview participants listed these areas as including Cape Town (South Africa), Callao (Peru), Las Palmas (Spain), Balboa (Panama), Cartagena (Venezuela) and Port Louis (Mauritius). It was explained that markets do not exist in most other areas, either because of the absence of infrastructure necessary to store shark carcasses in frozen form (-30°C), or a lack of a local or export market for shark meat. Even where markets do exist, the current price for shark meat is low: large sharks (≥10kg) sell for ≈ 60 cents per kg and small sharks sell for 20 cents per kg. It was stated that these markets existed prior to the implementation of shark finning policies, but it is clear that these low prices are insufficient to motivate retention of the whole shark carcass by tuna fleets, and one source admitted that finning will occur unless otherwise prohibited by law. Therefore, due to finning regulations and other factors, Japanese *enyo* vessels do offload shark carcasses for sale in some or all of these



areas during their frequent port calls<sup>4</sup>. The degree to which enforcement of finning regulations motivates shark meat landing is unknown, but respondents suggested the level of enforcement in South Africa is high, and that landing records are checked in Las Palmas.

While shark meat is only beginning to be landed, shark fins have always been utilized at a high rate. Previous information suggested that crew composition and compensation policies (McCoy and Ishihara 1999) can have a strong influence on the number of sharks finned. The interviewed *enyo* representatives stated that their crew was mainly composed of non-Japanese, mostly Indonesians or sometimes Vietnamese. One respondent agreed that several years ago special bonuses were offered to non-Japanese crew to encourage finning. However, he stated that recently the contracts for Japanese and non-Japanese crew have been standardized. Two other respondents mentioned that profits from finning are split in shares of 50:50 or 33:66 between the company and the crew.

There were two types of shark handling practices described in the *enyo* interviews:

- In one case, all hooked sharks are brought on board, the wire leader is wrapped around the shark to pin it, and the vertebrae is cut. If the shark is particularly active, a steel rod is used to destroy the spinal nerves. The fins are always cut and if there is a nearby market for shark meat, the carcass will be headed, gutted and retained.
- Other respondents indicated that large sharks (fins of 20-25 cm or longer at the longest edge, or larger than ≈20-30 kg) are stunned with a mallet, if necessary, then the vertebrae is cut and the fins are cut. If there is a nearby market for shark meat the carcass is headed and gutted and any live embryos released; if there is no market the carcass will be discarded. Smaller sharks have the hook pulled out by force and are discarded overboard. Whether these sharks survive depends on where they were hooked and how much damage is done by pulling out the hook, i.e. they are not finned. These fishermen's perspective was that it was better not to catch sharks and they were pleased if the set contained no sharks.

Interview participants stated that even if the rest of the catch is sold in foreign ports, most fins are retained onboard until the return to Japan, but a small percentage of fins may be transshipped at sea or sold in foreign ports<sup>5</sup>. Respondents stated that shark fins will command a higher price if they are dried, therefore prior to finning regulations 95% of vessels would dry fins on deck in a windy, though not necessarily sunny, area. However, in recent years a greater proportion of fins are being frozen to avoid the conspicuous presence of shark fins on deck, which is believed to lead to increased at-sea inspections (particularly in South African waters).

#### **A5.5.2. Kinkai fleet handling and disposition**

The *kinkai* fleet displayed the widest range of targeting strategies, including different gear and fishing ground variations by season, and thus showed the greatest diversity in shark handling and disposition. Despite this variation, fishermen could generally be divided into two groups with regard to their interactions with sharks: a) bycatch fisheries outside of Kesenuma, which fin sharks and discard the carcass; b) bycatch or shark targeting fisheries in Kesenuma which utilize both fins and meat.

The one fishermen from a bycatch fishery located outside of Kesenuma who was interviewed usually fins sharks and discards the carcass. He reported using both wire and monofilament leaders, sometimes in the same set or even the same basket. The lack of a local market was cited as the reason for not utilizing shark meat. Sharks are handled by gaffing and then cutting off the head and fins. The only sharks which are sometimes retained whole are the thresher sharks which were claimed to have lower urea content than other sharks. Other sharks including shortfin mako sharks are reportedly finned and discarded.

<sup>4</sup> In fact, in the three largest foreign landing ports used by the *enyo* fleet (Callao, Las Palmas and Cape Town), the industry (Japan Tuna) provides support in selling shark meat. The meat is reportedly destined for European markets in Italy and Spain.

<sup>5</sup> There is no formal support by the Japanese tuna industry for the selling of shark fins in foreign ports as this business is reported to be tightly controlled by local syndicates.

Extremely large sharks may be cut off the line to avoid endangering the crew. This fishermen explained that he provides an incentive to his crew, which are mostly Filipino, to fin sharks by offering each of them a bonus of 5,000-10,000 yen (roughly 50 -100 USD) per cruise if they fin hauled sharks.

Interviews were also conducted with representatives of fisheries utilizing the whole shark mainly based in or around Kesenuma (n=13), where there is a stable market for shark products. These vessels are usually targeting billfish with shallow sets<sup>6</sup> or tuna, such as bigeye, with deep sets, but some vessels also explicitly targeted sharks during some times of the year. Shallow set operations for billfish are believed to catch more sharks, and especially when billfish numbers are expected to be low, wire leaders are often used to maximize retention of hooked sharks. One respondent claimed that catching 10 blue sharks would be equivalent in value to catching 1 billfish. The price for blue shark meat in Kesenuma at the time of the interview (April 2006) was \$1.70 to \$2.10 US per kg. A variety of practices were employed to handle the estimated 80-90% of sharks which are still alive when brought to the boat. These included:

- Gaff the shark, pull the shark with the wire leader so that it is pinned against a large object and using 3-4 crew to immobilize it, cut the vertebrae<sup>7</sup>;
- Hit the shark with a long handled wooden mallet to immobilize it before cutting;
- Drag the shark by means of the leader into a clamping device bolted to the deck (flat on one side, convex on the other, dimensions of 50 cm length, 44 cm width, 16.5 cm height with a 1.1 m closing handle pole (Fig. A5.8)); close the clamp and kill the shark with a steel pike.



Fig. A5.8. Clamping device designed and used by one *kinkai* fisherman based in Kesenuma for immobilizing sharks (photo courtesy of T. Miyamoto).

<sup>6</sup> One respondent mentioned that the Kesenuma style of fishing for billfish is similar to that used in the Hawaii longline fishery.

<sup>7</sup> While some respondents claimed this could be achieved by one crew member "riding the shark" while the others assisted, this was considered too dangerous by other respondents due to the possibility of rolling.

When cutting the head, as much as possible of the vertebrae near the dorsal surface is retained but the gills, located at the same anterior distance from the snout on the ventral surface, are removed. This is achieved by means of an S-shaped cut through the vertical axis of the shark. After removing the head, the shark is gutted but the fins are left intact. According to interviews with Kesenuma-based fishermen, there is no shark that is too big to be landed and all sharks which do not bite off the hook and escape will be brought on deck. A few respondents said they would release small sharks if they are still alive after hauling.

### A5.5.3. Engan fleet handling and disposition

With some minor exceptions, shark handling and disposition practices in the *engan* fleet were similar to those in the *kinkai* fleet. Among the interview participants, several of the fishermen out of Kii-Katsuura (n=4) used an electric “shocker” device to stun sharks in the water before they are brought on deck. This device changes handling practices but did not seem to influence overall shark disposition (i.e. whether or not the carcass is retained). Another major difference was found in *engan* fishermen in Kii-Katsuura: while the market for shark products was deemed too small to warrant shark carcass retention by the Kii-Katsuura based *kinkai* fisherman (see above), the Kii-Katsuura *engan* fishermen usually retain shark carcasses<sup>8</sup>. There is a small shark products factory in Kii-Katsuura which processes shark meat, including blue and thresher shark meat, into semi-dried filets (*tareboshi*), processes a small number of fins, and sells the remaining fins to a dealer in Kobe for export to China (Fig. A5.9).



Fig. A5.9. Shark meat and fin to be used for tareboshi and hukahire products at a small factory in Kii-Katsuura (photos courtesy of T. Miyamoto).

On the smallest of the *engan* vessels, captains fish alone, i.e. without crew. Three of the four respondents in this category use nylon monofilament leaders to target tuna and billfish. The other respondent usually targets tuna with monofilament leaders but during the summer months he targets sharks using wire for the last 1 m of the branch line<sup>9</sup>. Due to crew limitations, these fishermen were forced to take a practical approach to shark handling, therefore they will release sharks by cutting the line: a) when the shark is small and they wish to save time; b) when it is approaching sunset and the haul is still not finished; or c) when fishing for tuna and the shark is any species other than thresher (the seasonal fisherman). When sharks are hauled, the electrical “shocker” is used to send a 100-300V electrical current through a ring with a small opening in it (Fig. A5.10). This ring is slid onto the branch line

<sup>8</sup> Note that the large shark products market in Kesenuma encourages both *kinkai* and *engan* fishermen there to retain shark carcasses but the small size of the market in Kii-Katsuura will support only the *engan* shark catches.

<sup>9</sup> This fishermen claimed he was one of only two fishermen targeting sharks out of Kii-Katsuura in the summer months. Because of the high prices paid for thresher (\$250 US per fish) and shortfin mako (\$50 US per fish) he is targeting these species but the majority of his catch (20-30 sharks per day) is blue shark. His catch of fins and meat is sold to the small factory in Kii-Katsuura. Aside from this factory there are four other fin dealers in Kii-Katsuura with strong connections to the China market.

through the opening and dropped from the gunwhale down the line into the water until it contacts the shark. It is reportedly not dangerous to operate because the electric current is low and is effective only in water. Prior to its availability the crew used to have to try to immobilize the shark using the leader and fishermen complained that this was both dangerous and time consuming. Retained sharks are headed and gutted, and fins are retained on the carcass for cutting in the port. Embryonic sharks are discarded and sometimes swim away.



Fig. A5.10. The ring and electrical cord of the "shocker" device used by engan fishermen based in Kii-Katsuura to immobilize sharks. (Photo: T. Miyamoto).

Among the larger engan vessels, one targets sharks in the summer for the Kesenuma market, and several target tuna out of Kii-Katsuura or a variety of other ports in western Japan from Okinawa to Kesenuma.

- The Kesenuma-based fisherman is targeting salmon sharks (*Lamna ditropis*) but often catches blue or shortfin mako sharks. He reports catching as many as 200-300 salmon sharks in a single set. This species is apparently docile to handle and it is thrown into the hold, sprayed with cold water and settles down quickly. All processing, including cutting of the valuable heart, is done in Kesenuma.
- The more wide-ranging fishermen (n= 2) had differing perspectives on the value of shark meat but both utilized shark fins.
  - One fisherman realized that the demand for shark meat was expanding and had found markets for such meat in Kii-Katsuura, Choshi (Chiba Prefecture) and Shiogama (Miyagi Prefecture), as well as Kesenuma. For this reason, he retains any hooked shark in whole form (usually about 20 per set) by hauling it onboard, using shears clamped on the shark's head to immobilize it and head and gut it. Fins are left on the carcass. Profits from shark products are split evenly between company and crew but for other species profits are kept by the company. This respondent claimed that all large sharks would bite through the nylon monofilament leader and escape, but other sharks with the exception of threshers (due to danger from the long caudal fin) would be hauled.

- Another wide-ranging fisherman targeting tuna stuns all sharks with an electrical “shocker” before bringing them onboard, cuts the vertebrae as a safety precaution, fins the shark, and discards the carcass. He stated that all sharks will be handled in this manner regardless of size, though he noted most sharks he catches are in the range of 10-50 kg. Profits from shark fins will be split evenly among the crew without the company taking a share unless the catch is very high (e.g. 70 kg of fins worth 40,000-50,000 yen (350-450 USD)) in which case the captain will also take a share.

## A5.6. Depredation and Gear Damage Issues

In contrast to the variety of shark handling and disposition practices used by the interview participants, respondents shared a remarkably similar perspective on the problems of depredation and gear damage. The preceding discussion has clarified that in almost all cases Japanese longline fishermen will utilize, in whole or in part, hooked sharks and some vessels periodically target sharks. It is therefore expected that these fishermen might be more tolerant of the presence of sharks in their fishing grounds than fishermen who never utilize sharks.

All of the respondents had some experience with depredation of hooked tunas, billfishes, and/or sharks and cited this as a much more important issue than gear damage or loss. Nearly all of the fishermen fishing in offshore waters (*enyo* and *kinkai* fleets) cited depredation by *shachi* (either orca (*Orcinus orca*) or false killer whale (*Pseudorca crassidens*)) as their most significant concern<sup>10</sup>. Some respondents said these species present particular problems because of their dexterity, attributed to the tongue and a stunning blow from the tail, in eating the entire body of the fish and leaving only the head area near the hook intact<sup>11</sup>. According to respondents a clear sign of *shachi* presence is when depredation occurs in consecutive hooks along the main line, sometimes resulting in as many as 20-30 fish lost per day. Some reported that *shachi* numbers are increasing and cited encounter frequencies of 3-5 times per 25-40 set cruise. All respondents who complained of *shachi* depredation problems stated they would change fishing grounds immediately if *shachi* are encountered.

Other depredation problems were considered minor inconveniences. One fishermen who had 33 years of experience cited only one example of changing fishing grounds to avoid sharks: this was off Montevideo, Uruguay and involved sharks damaging tuna. Particular shark-related depredation problems were said to be caused by shortfin mako, oceanic whitetip or cookie cutter sharks (*Isistius brasiliensis*). The frequency and degree of depredation were described by various respondents as follows:

- On average, depredation of 7-8 swordfish per cruise (25 sets);
- In a worst case scenario, depredation of 2-3 swordfish per set, but many sets with no depredation;
- Depredation is not a problem because they lose only about 1 fish per 3-5 sets;
- Under normal conditions, depredation of about 3 tunas per set;
- A usual rate of depredation would be about 5% of hooked fish, or 1-2 fish per set.

One fisherman maintained that depredation only occurs if the fish dies before haulback. Several fishermen mentioned that seabirds, sea turtles and large squid are also a depredation nuisance especially in shallow sets where hooked fish tend to float near the surface. There was no clear consensus on the cost of depredation: some fishermen claimed that any

<sup>10</sup> One fishermen cited depredation of hooked fish by giant squid (*Architeuthis dux*) off Peru as an equally serious problem. Another *enyo* respondent cited depredation problems associated with “small whales” other than *shachi*.

<sup>11</sup> *Shachi* are also reported to be capable of picking bait off hooks during setting. One respondent claimed that *shachi* would not approach hooked billfish because of the threat of injury from the bill, but this was contradicted by another fisherman. One fishermen said that because of their depredation behavior *shachi* are sometimes hooked in the tail. Another claimed that *shachi* commonly co-occur with hammerhead sharks (*Sphyrna* spp.).

damage would result in water entering the muscle tissue and the ruin of the entire fish, whereas other fishermen claimed that the size of the bite would determine whether the fish could be sold. If it could be sold, the price of damaged fish would be at least one third lower than undamaged fish. All fishermen agreed that if the fish could not be sold, its remaining meat would be used as food for the crew. All respondents shared the belief that depredation is a natural phenomenon and must be accepted as one of the unavoidable costs of fishing.

With reference specifically to gear damage, the only issues were associated with nylon leaders since wire leaders tend to resist both bite-offs and tangling. Sharks biting through nylon leaders was not viewed as a problem by most fishermen who used them, i.e. in our survey, mostly respondents from Kii-Katsuura. In fact, to some fishermen nylon leaders were seen as beneficial in avoiding handling sharks although such fishermen very rarely or in many cases never intentionally cut the leader to release the shark. Instead they will land even small sharks in order to retrieve the gear. Two fishermen estimated from their experience that sharks will bite through nylon leaders about 50% of the time. Respondents pointed out that nylon leaders may resist bite-offs depending on whether the shark is hooked near the jaw or deep in the gut and that most bite-offs occur during hauling, not during the set itself. Two fishermen had seen sharks with multiple hooks in their mouths but this was considered a rare event (e.g. once in their entire time at sea). Most of the fishermen in the Kesenuma area, presumably because of the existence of a stable market for shark meat, use wire leaders which they prefer because they can always be retrieved and repaired, and will retain hooked sharks. Although instances of gear tangling due to shark interactions were acknowledged and were considered a larger problem than the loss of gear to bite-offs, respondents did not consider tangling a major issue.

#### **A5.7. Methods of Onboard Storage of Retained Sharks**

Only one respondent cited any problems associated with storing shark carcasses and this was an issue involving the abrasion of paint on freezer pipes due to the roughness of shark skin. Although some fishermen separated sharks from other fish in the hold, most did not, and none considered shark storage a problem in any way. Those fishermen who retained shark carcasses always left the fins attached to the shark, with the exception of thresher shark caudal fins which were cut to facilitate storage.

Interview respondents used a variety of cold storage techniques including ice, cold water freezer “pools”, standard freezers and ULT freezers. Those vessels with ULT equipment and cold water freezers stated that the use of this technology avoided any concerns regarding urea contamination of tunas and billfishes from sharks. One *enyo* fishermen using ULT technology explained, however, that sharks were often separated from other fish for ease of unloading. In this case, the shark storage area was located in the area where the bait was kept. As the cruise progressed, the bait was depleted and by the end of the cruise the area could store 10-20 mt of sharks.

Those vessels using standard freezers and ice potentially faced urea contamination problems and thus often stored sharks in special ways. One *kinkai* freezer vessel retained only thresher shark carcasses because he stated the urea content in this species (only) was low enough to avoid contamination. Blue shark fins were also stored in the freezer but in a separate area. Vessels landing in Kesenuma often retained whole sharks and thus had extensive experience in storing carcasses. Many of these fishermen used ice or bait to separate sharks from other fish in different compartments of the hold. Others used created layers in the hold by placing sharks at the bottom and other fish on top of the sharks. A combination of these two approaches was described in detail as follows:

*“At first the sharks and swordfish are put in separate compartments of the hold divided by planks. When the first compartment containing sharks is about a third to a half full, a thick ice layer is place on top of the sharks and swordfish are transferred from the separate hold to the top of the shark hold. This kind of storage continues as long as there is space to temporarily store the swordfish separately. Near the end of the cruise new swordfish are placed directly onto the top of one of*

*the nearly full compartments and the last available compartment is used exclusively for sharks. “*

In summary, none of the interviewed fishermen noted insurmountable problems associated with the storage of shark products, either fins or whole carcasses, in their holds. Those fishermen who retained whole sharks did so without the need to remove the fins on board, and through a variety of measures were able to prevent urea contamination of tuna and billfishes.

### **A5.8. Practices Employed to Reduce Shark Capture and Depredation**

As described above, only one fisherman recalled a situation in which special measures were taken to avoid shark catch and depredation (i.e. the Uruguay example). None of the other respondents admitted taking special evasive action. Most believed that if the goal was to catch tuna or billfish and minimize shark catches, this could best be achieved by a good understanding of which areas and techniques to deploy. In other words, the fishermen believed that the issue was simply a matter of proper targeting: in Japan those who involuntarily caught large numbers of sharks were generally considered to be inept<sup>12</sup>. Depredation was believed to be an inherent and unavoidable cost of fishing, and thus no fishermen had ever tried to minimize or avoid its impacts.

### **A5.9. Reasons for Discontinuing any Methods Attempted to Reduce Shark Interactions**

Other than avoidance of shark catches by changing fishing grounds, no special methods for reducing shark interactions have ever been applied by the interview participants. Therefore, no experience with discontinuing methods was cited.

### **A5.10. Perceptions on Efficiency and Commercial Viability of Strategies to Reduce Shark Interactions**

As described above, Japanese longline fishermen interviewed for this study have never applied any explicit strategies with regard to shark interactions. The following discussion is thus based largely on fishermen's prospective opinions rather than experience with individual strategies. It is useful to note that the vast majority of interview respondents stated either that there is no need for them to avoid sharks and/or that it is impossible to avoid sharks.

#### **A5.10.1. Avoiding areas with sharks**

Although most fishermen stated that they make no special effort to avoid shark interactions, this strategy was often cited as potentially the most effective in achieving this aim. The success of this technique will depend on the ability of the fishing master to determine which areas have the lowest numbers of sharks. The interview participants unanimously agreed that skillful fishing masters could easily control their shark interactions using an avoidance method. However, there was also a view that some low level of shark interaction was inevitable, even in the most optimal areas. It is probable that the acceptable threshold for shark interactions in Japanese longline fisheries is higher than in other fisheries which are tightly controlled by finning regulations and in which there are limited or no markets for shark products.

---

<sup>12</sup> Some interview participants acknowledged key differences between fishing conditions off Japan and those in Hawaii. For example, these respondents stated that for various reasons including sea temperature conditions, sharks and tuna/billfish occur in more distinct and separate areas near Japan than off Hawaii where such populations are frequently mixed.

**A5.10.2. Refraining from chumming or bait/offal disposal**

At present, no interview respondents chum during sets. According to some of the older fishing masters in Kesennuma, bags of bait used to be hung between branch lines and chumming was practiced in order to increase shark catches, but both methods were discontinued due to a combination of ineffectiveness and intensive manpower demands.

No special procedures for bait or offal disposal in present day operations were cited. Therefore, in practice, excess bait and offal are disposed overboard while hooks are still in the water but no adverse effects are reported. Contrary to expectations, two fishermen insisted that discarding shark heads and guts into the water will deter other sharks from approaching the area. This opinion met with skepticism when raised with subsequent interview participants and one fishermen claimed that this technique was likely to have the opposite effect.

**A5.10.3. Changing target depth and soak time**

Several fishermen believe that fishing at depths below 50-100 m will result in lower shark catches and rates of depredation. Some interview participants claimed that their lack of shark interaction problems was related to their use of deep sets (and nylon leaders), but none of the respondents decided their fishing depth based on this factor alone.

As mentioned above, soak time was not considered an important factor for sharks. Some fishermen mentioned that longer soak times could lead to higher shark catches and more depredation. However, one *kinkai* respondent explained that soak time is determined by the crew rotation schedule and thus there is little experience in this fishery with varying soak time (usually about 9-10 hours).

In a related issue, many participants believed that the number of sharks in an area will decline with repeated sets. One respondent claimed that shark catch in a subsequent set would equal only half that of the previous set in the same area, and that a third set's shark catch would be even lower.

**A5.10.4. Chemical and electrical deterrents**

Several of the interview participants targeted sharks during all or part of their operations and for this reason declined to comment on shark deterrent measures. All interview participants who stated an opinion on such deterrents cited concerns that such techniques would not be effective. Other articulated concerns included adverse environmental impacts (in the case of chemicals) and undesirable deterrent effects on target species. One fishermen believed there might be potential to use underwater sound waves as a deterrent.

Although not related to the interview program, an electrical shark avoidance device was tested in a coastal midwater trawl fishery in the Sea of Japan (Ishikawa Prefecture) in 2004 (personal observation). The purpose of the device was to deter predation by sharks on the cod end of the trawl during hauling. The device, mounted on the fishing vessel, emitted an electrical pulse into the waters in the immediate vicinity. It was believed by fishermen to be effective based on observations of sharks suddenly moving away from the cod end and the vessel once the electrical pulse was emitted. This example provides a useful illustration of electrical deterrents for sharks but the effectiveness of the device is yet to be fully proven, and it would have to be substantially modified before being applied to longline fisheries.

**A5.10.5. Artificial bait and other changes to bait type or attraction**

A variety of bait types were used by the interview participants but in all cases the choice of bait was for the purpose of attracting target species while minimizing cost, not for repelling sharks or other bycatch. The majority of interviewed fishermen believe that squid, especially small-sized squid, might be a preferred bait for sharks. These respondents also expressed the possibility that the rubbery texture of squid makes it less likely to fall off the hook or for fish to bite it off the hook and thus the use of squid bait could lead to higher shark catches. One former fishing master listed bait types in descending order of preference by sharks: squid, mackerel, good quality herring, horse mackerel, saury, scad and poor quality herring. Squid is also a useful bait for billfishes and tuna, especially bigeye tuna, but one box of squid bait costs approximately three times as much as a box of mackerel bait and contains fewer



pieces when compared to other bait. For this reason, many fishermen do not often use squid bait and those that do use it alternate squid with other bait in a pattern within the same basket. Based on this information, avoidance of squid bait, if possible, might be useful in reducing shark hooking rates.

Interview participants had no experience with artificial bait but generally doubted its effectiveness based on a belief that sharks will take any bait. In support of this opinion, one fisherman cited his experience of seeing oceanic whitetip sharks eating plastic. Only one fisherman who had read about artificial bait trials seemed hopeful about their prospective use.

Lightsticks are never used in the Japanese longline fleet due to cost. For this reason, respondents generally had no opinions on the effect of lightsticks on shark catch rates. However, one fisherman said that the use of lightsticks would have no effect on sharks.

#### **A5.10.6. Reducing injury to discarded sharks**

Use of a de-hooking device or other methods of freeing hooked sharks while retrieving the gear seemed unreasonable to most interview participants due to the widespread utilization of shark catches, either whole or in part. The only sharks which are reportedly released are extremely large sharks, which cannot be safely handled and require cutting the leader, and very small sharks, for which retention is not cost-effective and which can be de-hooked without serious risk to crew. In both cases, special de-hooking technology was not considered necessary. Under current practices, crew injuries from sharks were considered rare events and not of particular concern, however, if more careful de-hooking procedures were followed for the sake of minimizing mortality to sharks, concerns about crew injuries may increase.

In contrast to the experience of fishermen in other longline fleets, Japanese longline fishermen did not believe that releasing sharks alive would lead to more sharks being hooked multiple times. In addition to fishermen very rarely seeing sharks with old hooks in their mouths, one fisherman cited results from a recent NRIFS experimental fishing survey in which sharks released alive did not return to the area to bite hooks again<sup>13</sup>.

#### **A5.10.7. Change in gear (hooks or leaders)**

Most fishermen who have experience with nylon monofilament leaders agreed that their use resulted in a lower shark catch, e.g. a 66% reduction was cited, due to biting off of the hook. Some interview participants saw this as an advantage since it reduced the need to handle large and dangerous sharks. In contrast, some fishermen preferred wire leaders because they are more easily retrieved and repaired and all fishermen specifically targeting sharks used wire leaders to prevent bite off. Among fishermen who do not target sharks, *enyo* fishermen targeting tuna used wire leaders until about 1990 but then switched to nylon monofilament. This change was made to improve the natural-looking movement of the bait on the hook which is particularly important when targeting tuna. In the *kinkai* fleet, targeting strategies and thus gear configuration, varied considerably: wire leaders were used to opportunistically target tuna, billfish or sharks; wire leaders were used to target billfish specifically; and a mixture of wire and nylon monofilament leaders were used within the same basket to target tuna. *Engan* fishermen not targeting sharks reported using nylon monofilament leaders to target tuna and billfish. All of the interviewed fishermen selected their leader material with regard to its effectiveness in catching their target species. Since they do not consider shark interactions a major issue they have never contemplated changing the leader material to reduce depredation or shark catch. No injuries associated with the snapping of nylon monofilament branch lines by sharks during hauling were reported.

A few fishermen had experience with, or opinions on, circle hooks. The results of field trials by NRIFS have indicated that the catch rate for blue sharks and the proportion of hooked blue sharks which were dead did not differ significantly by hook type (Yokota et al. 2006a, 2006b). One *enyo* fisherman believed that circle hooks could reduce shark and turtle interactions without causing a decline in tuna catches while another said that hook shape would not affect shark catch rates. The *kinkai* fisherman using mixed wire and nylon

<sup>13</sup> NRIFS scientists subsequently stated that this claim is not supported by their survey records.

monofilament leaders to target tuna stated that he is using circle hooks but they don't result in any change whatever in catches. Another *kinkai* fishermen explained that smaller hooks will catch fewer sharks and the same number of tuna and billfishes. An *engan* fisherman fishing offshore for tuna, billfish and sharks had previously tried circle hooks but had found them unsatisfactory since they reportedly did not attach firmly and tended to lose bigeye tuna off the hook. One respondent mentioned that the size of the circle hook used in Japan was smaller than that in used in Hawaii because of differences in target species and sizes.

#### **A5.10.8. Most important factor in determining shark CPUE**

The majority of participants named location (i.e. temperature, position with regard to oceanic fronts, and latitude) rather than depth, soak time, gear or any other factor as the most important factor in determining shark interactions. As mentioned above, interview participants consider that their fishing grounds are well-understood and are comprised of distinct species assemblages that can be easily targeted by skillful fishermen. Since this knowledge is felt to be part of their intellectual capital, and in fact many fishermen specifically target sharks, there was a general reluctance to provide detailed information about targeting strategies and success rates.

#### **A5.11. Incentives and Attitudes toward Reducing Shark Bycatch and Depredation**

As explained in several of the preceding sections, the interviewed representatives of the Japanese longline fisheries do not consider shark interactions a problem in their operations. This is due in some cases to an ability to avoid sharks through skillful selection of fishing grounds, and in many cases to the opportunity to utilize sharks either in whole or in part at existing landing ports. When depredation occurs it is almost always considered a natural and unavoidable phenomenon and no evasive action is taken.

The utilization of shark fins, which has always been high, is now accompanied by growing markets for shark meat. In some areas, e.g. South Africa, the retention of shark meat is likely to be motivated by finning regulations rather than price because the value of shark meat is very low (< 1 USD per kg) relative to tuna. In Japan's markets the price of shark meat is >2 USD per kg and reportedly rising due to a shortage in raw materials for surimi production. Still, the value of shark meat is low relative to other species and, assuming other species can be caught, several *engan* and *kinkai* fishermen believe it will never be profitable to retain shark meat. Utilization of sharks in Japan is closely related to whether the shark catch can be landed in Kesennuma where there is strong market for fins and meat, and a reportedly declining market for cartilage and skin<sup>14</sup>. Fishermen explained that in Kii-Katsuura, where fishermen are primarily landing tuna, the combination of unreliable supply of sharks and low price for meat has prohibited the expansion of the shark meat market while allowing several fin dealers to operate.

A few respondents felt that catches were generally stable but several fishermen reported that shark numbers appear to be declining. Various reasons for the perceived decline were given including a lack of prey, a jump in fin prices in 2002 (from 600 to >2000 yen (5 to 17 USD) per kg), finning activities by other fleets, and recent abundant swordfish catches which have resulted in lower retention rates for hooked sharks. It should be noted that the opportunistic targeting strategy of Japan's *engan* and *kinkai* fisheries creates difficulties when drawing conclusions about shark abundance from catch or landings statistics.

While many interview participants knew of controls on finning in other parts of the world, a few fishermen who finned sharks were not aware of any regulation or controversy surrounding this issue. Some fishermen who reportedly do not routinely fin sharks voiced a strong opposition to finning regulations. Other respondents believed that the issues of shark utilization and ecosystem balance were more important than a ban on finning per se. In summary,

<sup>14</sup> Fishermen in Kesennuma reported that only salmon shark livers are utilized (for fertilizer); all other shark livers are discarded at sea. There is no active market for shark teeth or jaws in Kesennuma.

Japanese longline fishermen have reportedly adapted to finning regulations applicable in some areas by landing sharks in recently developed local markets rather than by attempting to avoid shark interactions. In waters without finning regulations, including Japanese waters and the North Pacific, sharks are either finned or landed whole, and in either case the ability to sell shark products has contributed to a lack of interest in reducing shark bycatch.

## A5.12. References

- Clarke, S.C., M.K. McAllister, E.J. Milner-Gulland, G.P. Kirkwood, C.G.J. Michielsens, D.J. Agnew, E.K. Pikitch, H. Nakano and M.S. Shivji. 2006. Global Estimates of Shark Catches using Trade Records from Commercial Markets. *Ecology Letters* **9**: 1115-1126.
- FAO. 2004. Implementation of the International Plan of Action for the Management of Fishing Capacity (IPOA-Capacity): Review and Main Measures. Report of the Technical Consultation to Review Progress and Promote the Full Implementation of the IPOA to Prevent, Deter and Eliminate IUU Fishing and the IPOA for the Management of Fishing Capacity (TC IUU-CAP/2004/4), 24-29 June 2004. Available at <ftp://ftp.fao.org/fi/DOCUMENT/tc-iuu-cap/2004/default.htm>
- FAO. 2006. FISHSTAT Plus (v. 2.30), Capture Production Database, 1970-2004, Food and Agriculture Organization, Rome, Italy, available online at [www.fao.org/fi/statist/FISOFT/FISHPLUS.asp](http://www.fao.org/fi/statist/FISOFT/FISHPLUS.asp).
- Government of Japan. 2001. National Plan of Action for the Conservation and Management of Sharks. Available at <ftp://ftp.fao.org/FI/DOCUMENT/IPOAS/national/japan/NPOA-sharks.pdf>
- MAFF (Ministry of Agriculture, Forestry and Fisheries). 2003. 漁業・養殖業生産統計年報, 平成15年 (*Capture Fisheries and Aquaculture Production Statistics Yearbook 2003*), 農林水産省統計部 (Ministry of Agriculture, Forestry and Fisheries), Tokyo, Japan.
- MAFF (Ministry of Agriculture, Forestry and Fisheries). 2005. 漁業・養殖業生産統計年報, 平成17年 (*Capture Fisheries and Aquaculture Production Statistics Yearbook 2005*), 農林水産省統計部 (Ministry of Agriculture, Forestry and Fisheries), Tokyo, Japan.
- Japan Times. 2006. Oil-price spikes hit deep-sea tuna fishing industry. 3 April 2006.
- McCoy, M.A. and H. Ishihara. 1999. The Socio-economic Importance of Sharks in the U.S. Flag Areas of the Western and Central Pacific (Administrative Report 274 AR-SWR-99-01). National Marine Fisheries Service, Long Beach.
- Miyake, M.P., N. Miyabe, and H. Nakano. 2004. Historical trends in tuna catches in the world. FAO Fisheries Technical Paper 467. Food and Agriculture Organization of the United Nations, Rome.
- Miyamoto, Y., K. Uchida, R. Orii, Z. Wen, D. Shiode and T. Kakihara. (2006). Three-dimensional underwater shape measurement of tuna longline using ultrasonic positioning system and ORBCOMM buoy. *Fisheries Science* **72**(1): 63-68.
- Myers, R.A. and B. Worm. 2003. Rapid worldwide depletion of predatory fish communities (Supplementary Figure 1). *Nature* **423**: 280-283.
- Nakano, H. and S. Clarke. 2006. Filtering method for obtaining stock indices by shark species from species-combined logbook data in tuna longline fisheries. *Fisheries Science* **72**: 322-332.
- Nakano, H. and M.P. Seki. 2003. Synopsis of biological data on the blue shark (*Prionace glauca* Linnaeus). *Bulletin of the Fisheries Research Agency of Japan* **6**: 18-55.
- Nakano, H., H. Matsumoto, H. Okamoto, M. Okazaki. (2003). Acoustic tracking of the bigeye thresher shark (*Alopias superciliosus*) in the eastern Pacific Ocean. *Marine Ecology Progress Series* **265**: 255-261.
- Okamoto, H. 2004. Search for the Japanese tuna fishing data before and just after World War II. *Bulletin of the [Japan] Fisheries Research Agency* **13**: 15-34. (in Japanese)
- Shiode, D., F. Hu, M. Shiga, K. Yokota and T. Tokai. (2005). Midwater float system for standardizing hook depths on tuna longlines to reduce sea turtle by-catch. *Fisheries Science* **72**: 1182.

- Suisan Sougou Kenkyuu Center. (2006) 国際漁業資源の現況 (平成 17 年度)。水産庁・水産総合研究センター (The current status of international fisheries resources – 2004 edition, Fisheries Agency/Fisheries Integration Research Center).
- Suzuki, Z., Y. Warashina and M. Kishida. 1977. The comparison of catches by regular and deep tuna longline gears in the Western and Central Equatorial Pacific. *Bulletin of the Far Seas Research Laboratory* **15**: 51-89.
- Yokota, K., H. Minami and M. Kiyota. 2006. Measurement-points examination of circle hooks for pelagic longline fishery to evaluate effects of hook design. *Bulletin of the Fisheries Research Agency* **17**: 83-102.
- Yokota, K., M. Kiyota and H. Minami. 2006. Shark catch in a pelagic longline fishery: Comparison of circle and tuna hooks. *Fisheries Research* **81**: 337-341.

## Appendix 6

### Peru Artisanal Mahimahi and Shark Longline Fishery: Industry Practices and Attitudes towards Shark Depredation and Bycatch

Jeff Mangel and Joanna Alfaro-Shigueto, Pro Delphinus,  
prodelphinus@prodelphinus.org

Forty-two interviews with artisanal longline fishermen for mahi mahi were conducted in three fishing ports in Peru from February to May 2006. Of these, five interviews were with vessel owners who had been actively fishing from 2 to 28 years. Sixteen respondents were vessel captains and the remainder was crew. The average number of years fishing by owners, captains and crew were 18.6, 9.7, 7.3, respectively. Information on the artisanal longline fishery was obtained from Instituto del Mar del Peru (IMARPE) reports on artisanal fisheries, from Food and Agricultural Organization (FAO) publications that make reference to Peruvian fisheries, and from the Fishstat computer program produced by FAO. Data on Peru's export market were obtained from PROMPEX Peru (government commission for export promotion), and were downloaded from their website ([www.prompex.gob.pe](http://www.prompex.gob.pe)).

The purpose of this study is to identify possible strategies to reduce shark bycatch and depredation in pelagic longline fisheries. This study was conducted during the mahi mahi season of the Peru artisanal longline fishery, when sharks are taken as incidental catch. During other seasons sharks are a primary target species.

#### A6.1. Elasmobranch Fishery

Chondrichthyans constitute an important fishery resource for developing countries (Cattarci, 2004). With the shortage of traditional bony fish landings, the need for a protein source and the increase in the demand for shark fins, the take of sharks has expanded significantly in the last few years (Bonfil, 1996; Cattarci, 2004). In developing countries such landings have increased by 600.5% from 1950 to 2000 (Cattarci, 2004).

Peru is one of the world's leading fishing nations and has been for many years (Vanuccini, 1999). However, the elasmobranch fishery represents a minor component of Peru's total landings even though it is the third largest in the Americas (Bonfil, 1996). Elasmobranch landings in Peru have been dominated by smoothhounds ('tollos') of the genus *Mustelus*, guitar rays *Rhinobatos planiceps* and angel sharks *Squatina* spp. (Fig. A6.1, Table A6.1) (Bonfil, 1996; FAO 2006). These species are caught mainly with gillnets (Reyes, 1993).

Since the mid to late 1980s the production of smoothhounds and rays has declined. With the reintroduction and extension of longline fishing for sharks in the 1990's (Reyes, 1993), landings of shark species, such as blues and makos, have increased (Estrella and Guevara-Carrasco, 1998a and 1998b; Estrella et al., 1998, 1999a, 1999b and 2000).

Shark fisheries in Peru are regulated by the Ministry of Fishery through the establishment of minimum capture sizes for some elasmobranch species (Diario Oficial El Peruano, 2001). Enforcement of these regulations, however, has not been fully implemented and awareness of these regulations among fishermen is still limited (Alfaro and Mangel, 2005).

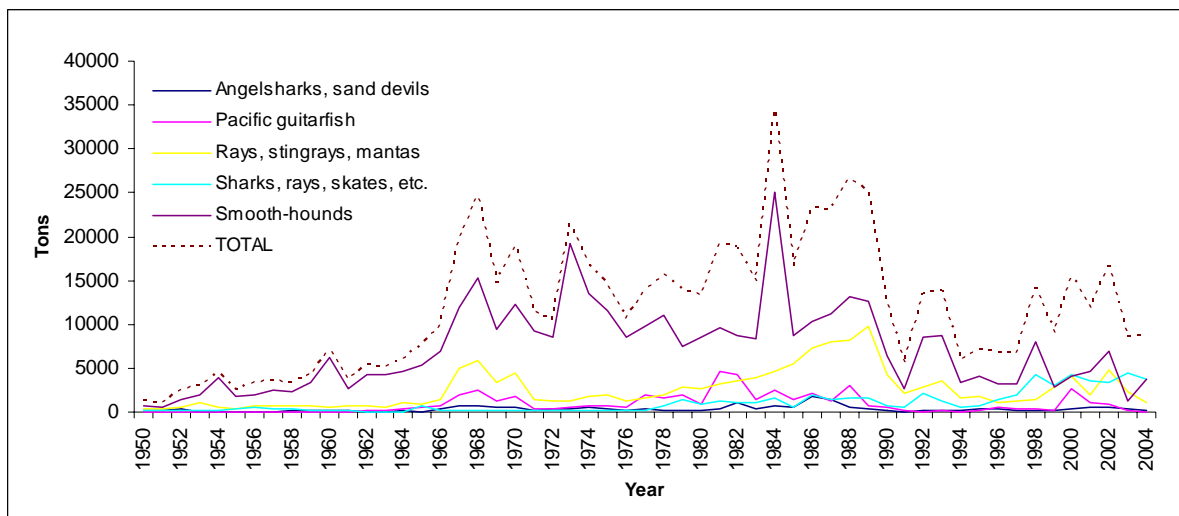

Fig. A6.1. Total elasmobranch production in Peru, by species groups, 1950-2004 (data are taken from FAO 2006).

Table A6.1. Landings in metric tons from the elasmobranch fishery in Peru from 1990-1999 (in Cattarci, 2004).

Species	1990	1991	1992	1993	1994	1995	1996	1997	1998	1999
Rays	4311	2081	2771	3632	1658	1841	1126	1177	1477	1790
Smoothhounds	6458	2705	8578	8747	3431	4125	3230	3166	8038	448
Sharks	768	525	2087	1212	548	694	1506	1915	4335	2043
<b>Total</b>	<b>11537</b>	<b>5311</b>	<b>13436</b>	<b>13591</b>	<b>5637</b>	<b>6660</b>	<b>5862</b>	<b>6258</b>	<b>13850</b>	<b>18131</b>

## A6.2. Artisanal Longline Fleet Characteristics

Longline fishing was reintroduced in Peru in the late 1980s (Reyes, 1989) due in part to the collapse of traditional fisheries for boney fish (Bonfil, 1996; Cattarci, 2004) and the search for new fishing techniques. By the 1990s this fishing method had expanded, especially in Peru's southern ports (Escudero, 1997; Castejon pers comm.). During the past decade the longline fishery has increased significantly. The main target species are mahi mahi *Coryphaena hippurus* during the austral summer and sharks, especially blue sharks *Prionace glauca*, mako sharks *Isurus oxyrinchus* and hammerhead sharks *Sphyrna zygaena*, from autumn to spring.

Artisanal fisheries are defined according to Peruvian fisheries regulations as containing boats with a maximum of 32.6 m<sup>3</sup> of storage capacity, 15 m in length, and principally based on the use of manual work during fishing operations (Ley General de Pesca, 2001).

By the 1990's there were an estimated 190 longline vessels in Peru (Jahncke et al., 2001). More recent information estimated that approximately 1500 longline vessels operate during the mahi mahi season (IMARPE, unpublished data).

Peru's artisanal fleet is very large and diverse. Artisanal fisheries contain mainly wooden vessels. A 1997 study of the fishery indicated that there were more than 28,000 fishermen and 6,200 vessels operating out of 109 ports (Escudero, 1997). One of the main fishing methods employed is longlines. Statistics from IMARPE indicate that 1,968 longline trips were recorded for the second half of the year 1999 (Estrella et al., 2000). More recent information on artisanal longlines indicates that in 2002, 11,316 trips were conducted (IMARPE, unpublished data). This suggests substantial growth in the longline fishery since 1999.

While there is much variation in longline fishing methods throughout the country, some general characterizations can be made (Fig. A6.2, Table A6.2). Longline vessels typically set their gear in the morning and recover it in the early evening. Gear is set at the surface. Mainline length varies by boat and number of hooks but is typically about 3-4 km. in length (See Fig. A6.2). The main target species include sharks and mahi mahi. Sharks are fished from approximately March to November and mahi mahi are fished from December to February. Trip length varies by season with mahi mahi trips typically lasting 5-7 days and shark trips lasting 15-20 days. Vessels may travel up to 250 miles from shore. Hook size and type varies but almost all vessels use J hooks. Northern ports tend to use smaller hooks than in the south. Species used for bait include giant squid, mackerel, and flying fish. Bait may be fresh, frozen or salted. Weighted branchlines are used in some ports, and are used more often in the south of the country. Steel leaders are often used during shark season to reduce gear loss.

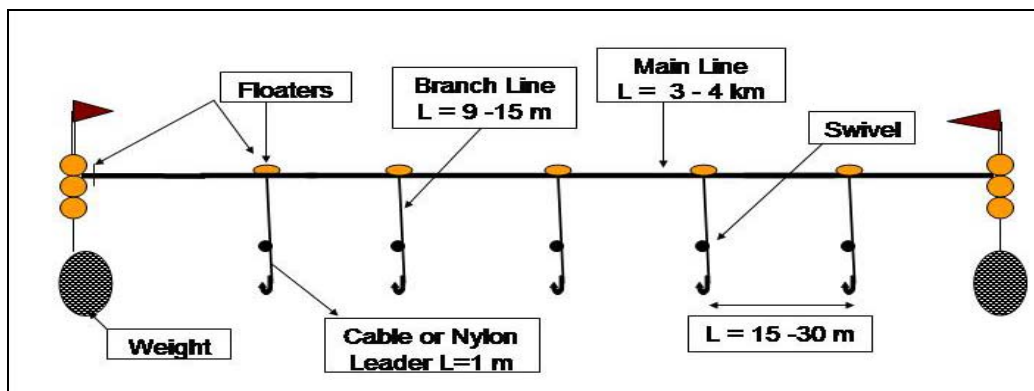

Fig. A6.2. Typical gear design of a Peruvian pelagic longline.

Table A6.2: Characteristics of the mahi mahi and shark seasons of the Peru longline fishery .

Gear Characteristic	Seasonal Target Species	
	Mahi Mahi	Sharks
Hook Type	J#2	J#0, 1/0
# Hooks	600-1500	800-2000
Trip Length	Up to 6 days	Up to 20 days
Sets/Day	1-2	1
Distance	20-70 nm	250-500 nm
Bait	Flying fish, squid, mackerel	Flying fish, squid, mackerel, cetaceans
Season	December - March	April – November
Target Species	Mahi mahi	Mako & Blue shark

There are very few restrictions on the operation of artisanal vessels. There are no quotas on the number of vessels, number of vessels per owner, or on the longline gear itself. Monitoring of landings is conducted by the Ministry of Fisheries and by IMARPE. Monitoring is done in terms of metric tons of specimens landed. Only the commercial species are monitored. Vessel departure permits and security controls are managed by the Peruvian Navy - Direccion de Capitanias y Puertos (DICAPI).

### A6.3. Range of Fishing Gear and Methods

Table A6.3 summarizes the general fishing methods and gear deployment strategies for the longline fleet in the ports where surveys were conducted - Paita, Salaverry and Ilo. It should be noted, however, that fishing methods and gear deployment vary somewhat from port to port and vessel to vessel.

Table A6.3. Fishing gear deployment of the Peruvian artisanal mahi mahi longline fishery (Mangel and Alfaro-Shigueto, 2003 and data from interviews conducted in this study).

Mainline material	'Papelillo' (blue multifilament nylon rope)
Mainline length	Average of 3 kilometers
Mainline deployment	Manual
Distance between buoys	27 m (15 fathoms)
Distance from buoy to mainline (float line length)	~0.15 m
Average branch line length	9 to 10 m
Branch line material	Nylon monofilament/cable
Wire trace or leader on branch lines	Some use, but typically during shark season or at the transition between shark and mahi mahi season (1 m length)
Number of hooks between buoys	1 to 2
Average maximum depth of hooks when set	18 m (87% fishermen say set at 10bz or less)
Average maximum depth of mainline when set	Surface
Mainline sink rate	No information available
Timing of set, soak, and haul	Gear is set in the early morning, soaks during the day, and is hauled before dark.
Lightstick use	No
Number of hooks per set	average 700 for mahi mahi season (range: 600-1500)
Hook setting interval	No information available
Radio beacons	No
Hook type	Mustad #2, #3, #4 J hooks 10 degree offset
Weight size and location	No weighted swivels used for mahi mahi 46.2 g swivels, located ~67cm from hook for sharks
Clip size and type	Not typically used
Bait type	Mackerel, flying fish, squid
Number of crew	Captain and 3 crew
Vessel Monitoring System	No

#### A6.4. Catch and Discard Rates of Target and Bycatch Species

A summary of catch rates for the Peruvian artisanal longline fleet in the port of Ilo during the summer mahi mahi season of 2005 and 2006 is presented in Table A6.4. Catch rates shown are for all caught fish (both retained and discarded).

Table A6.4. Catch rates during the mahi mahi season in the port of Ilo, 2005-2006 (Pro Delphinus, unpublished data).

Year	CPUE (number per 1000 hooks)		
	Mahi Mahi	Blue Shark	Mako Shark
2005	94.15	0.0	0.0
2006	95.69	0.65	0.0



Pro Delphinus onboard observers also collected data on catch composition for the port of Ilo. Table A6.5 presents catch composition data obtained from 35 observed trips during mahi mahi seasons from 2003 to 2006.

Table A6.5. Catch composition, by weight and value, for the port of Ilo, 2003-2006 (Pro Delphinus, unpublished data).

Species	Catch (x 1,000 kg)	Revenue (\$1000US)
Mahi mahi	74.247	95.036
Blue sharks	1.275	1.148
Mako sharks	0.817	1.511
Swordfish	0.106	0.248

During the 2005 mahi mahi season almost all sharks captured were retained and landed. Sharks were processed for both their fins and meat. Some rays were discarded, particularly in the port of Ilo, where they have no commercial value. In a few cases, small (below 60 cm in length) individual blue sharks were also released alive.

From 2004 to 2006 Pro Delphinus onboard observers monitored in detail the shark take during mahi mahi season in 4 ports for a total of 27 trips and 197 sets. Information on capture rates by species and fate of caught animals is presented in Tables A6.6 and A6.7.

Table A6.6. Number caught and disposition of sharks in Ilo and Salaverry longline fisheries (Pro Delphinus, unpublished data).

Year	No. sharks caught	No. sharks discarded	No. sharks finned	No. whole sharks retained	Percent sharks retained (any part of individual shark is retained)	Percent sharks finned
2004-2005	139	8	0	129	93	0
2005-2006	27	1	0	26	96	0

Table A6.7. Number of sharks by individual species caught, proportion that are dead when hauled to the vessel, CPUE, number discarded alive, number discarded dead and number of whole sharks retained by the Peruvian longline mahi mahi fleet (Pro Delphinus, unpublished data).

Shark species	Number caught	Number dead when hauled to the vessel	CPUE (number caught per 1000 hooks)	Number discarded alive	Number discarded dead	Number whole sharks (carcass plus other parts) landed
Blue	108	4	0.5669	3	0	99
Mako	45	9	0.2362	5	0	35
Ray	22	0	0.1155	21	0	1
Hammerhead	4	3	0.0210	0	0	4
Other	9	8	0.0472	1	0	7

## A6.5. Regulations and their Implications for a Management Framework

In Peru there is a target fishery for sharks, which operates about 9 months of each year. Sharks are typically retained as an incidental catch during the other three months of the year when the fleet targets mahi mahi. There are regulations setting the minimum size of capture for some species such as the coastal smoothhounds from the genus *Mustelus* and *Triakis*, as well as for blue sharks, makos and hammerheads sharks. There is, however, little or no enforcement of these regulations.

Peru has no specific shark finning regulations. There is no apparent need for such regulations because both shark meat and fins are utilized and commercialized. Animals are typically retained and finned either onboard or at the port. The high number of shark landings and demand from the domestic market (Estrella and Guevara-Carrasco, 1998a, 1998b; Estrella et al. 1998, 1999 and 2000) as well as the international market for shark meat and fins (PROMPEX Peru, 2006) may help explain why shark finning does not occur in Peru.

The catch of rays with pelagic longlines is small. Species from the genus *Milyobatis* spp. (eagle ray) and other species such as skates from the genus *Psammobatis* spp. are captured but have no significant commercial value and are usually discarded.

## A6.6. Shark Market and Implications for the Management Framework

The shortage of traditional bony fish (Vannuccini, 1999), the reintroduction of the longline as a fishing method (Reyes, 1989, Castejon pers comm.), and the market for shark fins as 'added value' to the commerce of the sharks, have combined to promote the development of a targeted shark fishery by Peru's artisanal longline fishermen.

During the 1990's, at least 70% of shark production went to the domestic market as fresh chilled product (Vanuccini, 1999). Exports of shark fins have increased from \$2.5 million in 1995, to approximately \$7.5 million in 2000 (PROMPEX Peru, 2006). The main markets for Peruvian shark fins are Hong Kong and Japan (Table A6.8).<sup>1</sup>

Still, the domestic market for fresh meat drives the industry more than the fin price. The higher trading price for fresh-chilled meat compared with other products demonstrates that the domestic market absorbs most of the shark landings. Inland towns also offer a market for dried, salted shark meat (Vannuccini, 1999).

The export market for frozen shark meat has grown. From 2000 to 2005 exports of shark meat tripled (Table A6.9). During this same period, however, revenue from these exports only increased by 150%. In the 1990's shark meat was exported mainly to Spain (Vanuccini, 1999). More recently, the main export markets include Uruguay, Spain, Brazil and Colombia (see table 9; PROMPEX Peru, 2006). No information is available on the shark species exported.

The local market price for shark fins in Peru is around \$10/kilo fresh. The price for meat is about \$0.9 to \$1.85 per kilogram (Ilo fish market, May 2006). While shark fins have a higher value per kilogram than shark meat in the international market (Catarci, 2004), on an individual animal basis more money is earned by a fishing trip from the meat than the fins.

---

<sup>1</sup> All prices are given in U.S. dollars unless otherwise indicated.

Table A6.8. Peru exports of shark fins (Prompex, 2006).

Countries	1995		2000		2005	
	Kg	FOB Price <sup>1</sup>	Kg	FOB Price <sup>1</sup>	Kg	FOB Price <sup>1</sup>
Hong Kong	71,437.00	2,135,783.38	110,535.42	4,620,213.92	139,624.19	5,718,524.65
Japan	19,133.40	310,999.80	20,082.02	605,137.14	15,393.66	1,315,604.27
Costa Rica	2,443.62	87,086.49	9,137.00	495,216.00		
Ecuador	2,080.00	39,520.00				
Panama	1,007.00	29,946.00				
China	0.00	25,250.00			1,704.21	78,672.02
Canada	600.00	12,070.00	1,636.60	34,719.18	857.00	80,699.41
United States	118.00	7,543.50	6,065.78	108,131.60	4.20	630.00
Trinidad and Tobago			2,640.00	110,880.00		
Honduras			1,750.50	67,367.00		
Argentina			1,429.00	55,005.25		
Singapur			1,776.90	51,395.00		
Italy			15,908.00	17,498.80		
South Africa			11.16	529.50		
Taiwan					1,048.60	61,678.28
Vietnam					567.58	43,052.54
<b>Total</b>	<b>96,819.02</b>	<b>2,648,199.17</b>	<b>170,972.38</b>	<b>6,166,093.39</b>	<b>159,199.45</b>	<b>7,298,861.17</b>

<sup>1</sup> FOB = Free on board

Table A6.9. Peru exports of shark meat (Prompex, 2006)

Countries	2000		2005	
	Kg	FOB Price <sup>1</sup>	Kg	FOB Price <sup>1</sup>
Mexico	6,506.80	99,943.36		
España	39,400.40	78,198.00		
Dinamarca	23,740.50	55,139.06		
Italia	25,781.80	30,869.63		
Uruguay	49,000.00	27,440.00		
Korea	534.00	386.41		
United States	6870.08	18918.71	3,736.93	10,297.55
Hong Kong	10.00	10.00		
Nederlands	1.00	1.00		
Canada	5.00	14.00		
Brasil			251,606.00	295,363.25
Colombia			161,590.00	132,823.00
Guadalupe			2,603.00	5,617.10
<b>Total</b>	<b>151,849.58</b>	<b>310,920.17</b>	<b>419,535.93</b>	<b>444,100.9</b>

<sup>1</sup> FOB = Free on board

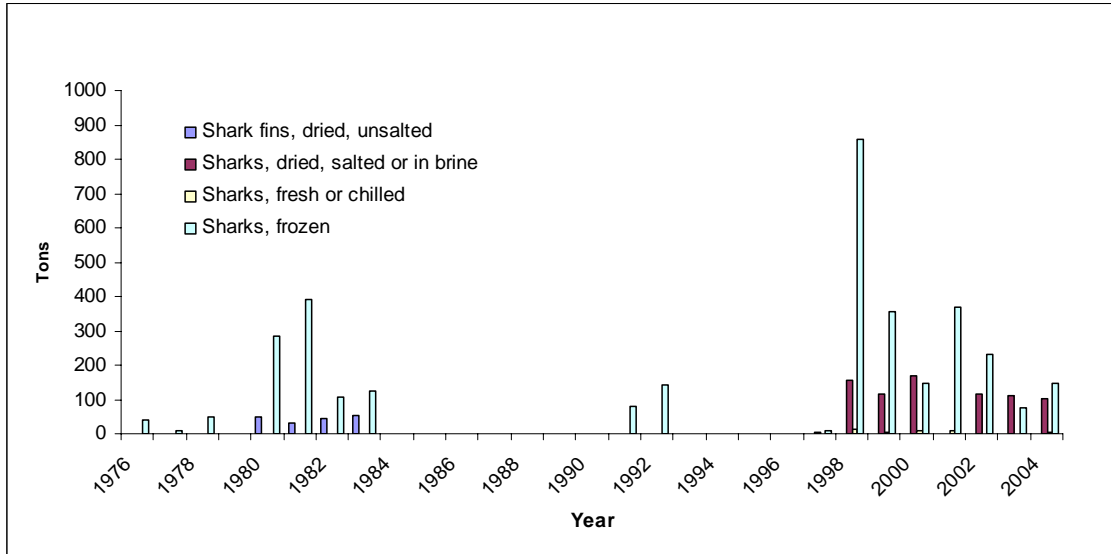

Fig. A6.3. Peru export quantity of shark products, 1976-2004 (FAO, 2006).

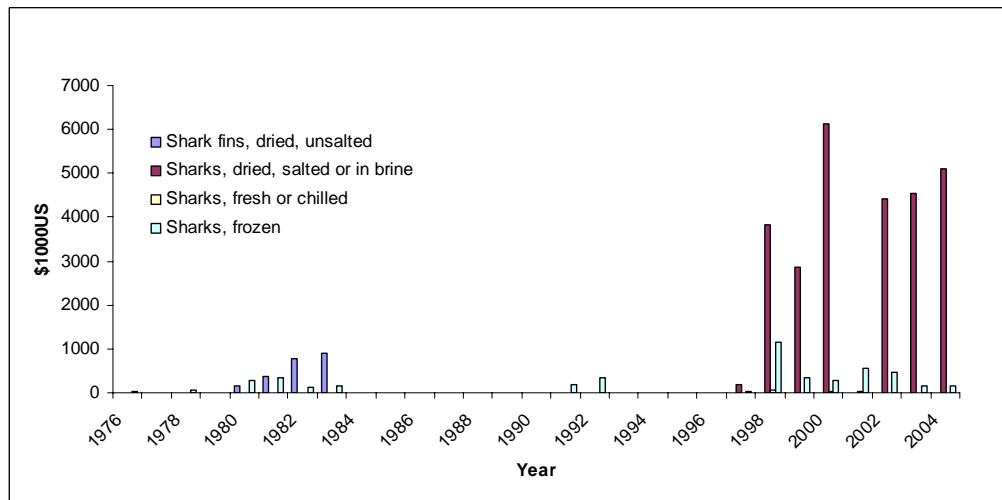

Fig. A6.4. Peru export value of shark products, 1976-2004 (FAO, 2006).

### A6.7. Economic, Social and Ecological Effects, Including Effects on Fishing Practices, from Regulations Governing Shark Interactions

From the forty-two fishermen interviewed, 16 were based in Paita, 10 in Salaverry and 16 in Ilo. Almost all (93%) interviewed fishermen report that they always retain sharks during the mahi mahi season. Regularly, blue and mako sharks are caught and the whole body and fins are retained. The whole crew and boat owner receive the revenue from the sale of fins and meat. In some cases, this money is used to cover expenses such as gas and food. Meat of blue sharks is sold for approximately \$0.5-1.3/kilo and makos for \$0.9-2.8/kilo. Revenue from fins ranges up to \$16 per kilo. Mako fins are more valuable than those from blue sharks.

Only three (7%) respondents replied that income from sharks has changed over the years. Two replied that in the past revenue from fins was retained by the owner only. One respondent indicated that revenue from sharks in the past was not as much as currently.

Revenue from the sale of jaws is retained by the members of the crew that clean them. One fisherman reported earning \$2-30 for selling jaws for decoration or for artisanal crafts. Other shark parts such as the “verija” (pelvic fins) are given to the fishmongers as payment for services. These products are later commercialized.

Regulations on minimum size of capture for sharks are not taken into consideration by most fishermen mainly because there is no enforcement by the government and because fishermen are not aware of them. Those fishermen (4.8%) who reported that they were aware of the regulations stated that they still retain sharks under minimum size of capture.

For most of the fishermen interviewed, revenue from catching sharks exceeds the costs associated with shark depredation and loss and damage to gear (average damage cost estimate per mahi mahi set was \$11). Most fishermen reported changing their fishing methods and gear during the mahi mahi season. These changes included using nylon monofilament leaders, using giant squid for bait, setting hooks shallower than during shark season and fishing in areas closer to shore. These gear changes reduce shark captures, but the purpose of the gear changes is to optimize mahi catch, and not to reduce shark catch. Fishing for mahi mahi during summer is more profitable because fishing areas are closer to shore and the amounts of mahi mahi are considerable higher than during the shark season. As a result, fishing trips are shorter and expenses (food and gas) are reduced.

#### **A6.8. Practices to Deal with Caught Sharks and Costs from Shark Depredation and Gear Damage**

Most longline vessels use an 80-100 cm nylon monofilament at the end of the branch line, located between the baited hook and a weighted or non-weighted swivel. Some fishermen use a mix of wire leaders and nylon monofilament depending on the time of year. Wire leaders are often used during shark season or toward the end of mahi mahi season when there is a higher chance of catching sharks.

As a result, respondents reported that about three quarters (82%) of sharks that bite baited hooks in mahi mahi gear bite through the monofilament line and are not retained on the line to be hauled to the vessel. Some respondents were not sure whether gear loss was due to sharks or manta rays. Ninety-two percent of respondents stated that during the mahi mahi season, vessels catch an average of 2.1 sharks on a typical set.

Almost all respondents indicated that they always retain sharks. Only 34% indicated that they release small sharks. Hooks from small sharks are almost always removed manually once the shark is on board. Four respondents (10%) mentioned that if the hook is not in the mouth then the animals are killed and retained.

Almost two-thirds of respondents reported that sharks will either break the main line or bite through the nylon monofilament in the branch line (thus losing hooks as well). The average cost reported from damage and loss of gear to sharks is \$11 on a typical mahi mahi set.

Fishermen reported having an average of 7.5 mahi mahi damaged from shark bites on a typical longline set. This represents a loss of approximately \$30 per trip depending on the size of the fish that are damaged. However, eight (19%) respondents replied that no mahi mahi are damaged by sharks in their typical sets, and that sea lions *Otaria byronia* and giant squids *Dosidiscus gigas* are the species responsible for most damage to target catch.

Over a third of respondents reported that shark interactions are a problem more because of the amount of time they have to spend to repair and replace loss of gear versus 21% who reported that the cost of lost and damaged gear were the main reason shark interactions are a problem. Another 21% of respondents replied that shark damage is a problem both in terms of time and cost. Only five respondents (12%) reported that neither time nor cost resulting from shark interactions was problematic. Reasons for this

response were that (i) repairing and replacing lost gear is fast, (ii) loss of gear by sharks is considered part of their work, and (iii) revenue from shark exceeds the cost of catching them.

Almost two thirds (60%) of interviewed fishermen would not avoid catching sharks if they could. The most cited reasons for this response were (i) that shark captures mean extra revenue because of their meat and high value fins, and (ii) that there is nothing to be done to avoid catching sharks since even when using monofilament nylon branch lines sharks are retained. More than one-third (38%) of respondents stated that they would avoid catching sharks because fishing for mahi mahi is more profitable during summer or for purposes of shark conservation (stating that summer time should be considered a temporal ban where they would let sharks reproduce). However, most (83%) of the interviewed fishers replied they would rather not avoid catching sharks because it is, in the end, more profitable for them. Some respondents also indicated that they reconfigure their gear to catch more sharks even before the start of a shark season.

### **A6.9. Methods for Onboard Processing of Retained Sharks**

Sharks that will be retained and landed are usually not finned. Animals are brought on board where they are immobilized. Sixty-four percent of respondents indicated that they immobilize the animal by cutting off the tip of the snout and passing a metal wire into the brain. Some respondents (12%) stated that they use a wooden stick to immobilize sharks by hitting them in the snout/head. Over half of them mentioned they would only use the wooden stick for mako sharks and the metal wire for blue sharks. After immobilization the animal is gutted, the head and tail are removed, and the animal is put on ice with the rest of the retained fish. Three (7%) respondents mentioned that they would place viscera and heads in a bag to be discarded at the end of the haul because they believe offal “would scare sharks away”. Finning of animals typically occurs at the port.

### **A6.10. Reasons for Discarding Sharks**

Despite regulations of minimum size of capture for some shark species, most fishermen (93%) do not discard any shark once it is hooked. Some fishermen (34%) reported that they discard sharks below 40-60 cm in length and only if they are alive when they are hauled to the vessel. The other fishermen (66%) report not discarding any sharks. Two fishermen reported that they do not retain any sharks - one because sharks contaminate the catch of mahi mahi, and the other because of the risk of getting injured from bites while hauling sharks aboard.

Shark meat and fins are marketable for several species (blue, mako, hammerhead, porbeagle and other Carcharinidae) and prices are generally equal to or higher than that of the target species mahi mahi. This high value for incidental shark take means that fishers will not discard incidentally captured sharks. Boat space for sharks is not considered a problem and fishermen retain sharks even during the first sets of a fishing trip. Less space for target species means only coming back early to the port. Sharks are preserved on ice covered with paper wrap and placed separate from target species to avoid contamination.

### **A6.11. Practices Employed to Reduce Shark Capture and Depredation**

Respondents identified employing several strategies to reduce shark capture and depredation. These strategies are practiced to increase mahi mahi capture, and are not necessarily intended to reduce shark capture. The most commonly identified practice to avoid shark interactions is by changing fishing position. During mahi mahi season fishing areas are closer to shore than those areas fished during shark season. Over half (52%) of fishermen interviewed indicated that they would change fishing position in order to reduce gear loss if the catch of sharks was especially high. Another 33% of respondents indicated that they would remain in the fishing zone. Three fishers indicated, particularly toward the end

of the mahi mahi season, that they would change monofilament lines for wire cables. The purpose of the gear change would be to increase shark retention, not to reduce gear loss. Wire leaders are not used during the peak of the mahi mahi season because fishermen believe it reduces target species capture.

### **A6.12. Reasons for Discontinuing any Methods Attempted to Reduce Shark Interactions**

No fisherman has tried or heard of any methods to reduce shark interactions. Only one fisherman responded that he would change the fishing area to catch fewer sharks.

### **A6.13. Perceptions on Efficacy and Commercial Viability of Strategies to Reduce Shark Interactions**

#### **A6.13.1. Avoiding peak areas and times of shark abundance**

Almost two thirds (64%) of respondents believe that shark catch rates will be highest in certain areas which are different from those of the target species. Half of respondents (50%) believe that it is possible to avoid peak areas and times of shark abundance. One third (33%) of respondents believe this is not possible because shark capture is more profitable and they would rather capture sharks if they encounter areas of high shark abundance. This was not the common view, however, because during the summer mahi mahi are more abundant and easily available.

#### **A6.13.2. Reducing the detection of baited hooks by sharks, such as by refraining from chumming during the set and not discarding offal and spent bait during the haul**

About half of respondents (48%) do not believe that refraining from chumming during the set and refraining from discarding offal and spent bait during the haul will reduce shark depredation and bycatch. Thirty-three percent of respondents believe it may help reduce interactions with shark species. All vessels discard spent bait and offal during the haul, and most respondents believe it would be impractical to retain spent bait and offal to discard at the end of hauling because of the lack of space on the vessels.

#### **A6.13.3. Limiting shark access to baited hooks, such as altering fishing practices to consider deployment depth of hooks and timing of the soak and haul to avoid problematic shark species**

Almost half (46%) of respondents believe that it is possible to reduce shark interactions by setting baited hooks shallower or reducing soaking time. Another 43% of respondents believe it is not possible because they still have shark interactions when setting baited hooks shallower. During mahi mahi season, baited hooks are set as deep as 6 fathoms whereas during shark season hooks are set as deep as 11 fathoms. None of the respondents mentioned setting baited hooks deeper because it would reduce their catch rate of target species.

#### **A6.13.4. Deterring sharks such as with chemical shark deterrents and electrical deterrents**

Only 17% of respondents believe that deterrents such as chemical compounds and electrical currents will be effective at reducing shark bycatch and depredation. Another 14% of respondents replied that they did not know of these deterrents or if they would be effective. Over half (62%) of respondents believe that using shark deterrents would not be feasible since they want to capture them due to their high economical value. Respondents (17%) who replied that these deterrents may work mentioned that they would probably be too expensive to use. Some respondents (14%) replied that shark capture is not a problem for them, but, rather, an economic benefit.

#### **A6.13.5. Reducing the attractiveness of baited hooks to sharks, such as by using artificial baits, using or not using light sticks, or avoiding a bait type known to result in high shark catch rates**

Over a quarter (29%) of respondents believe that avoiding bait types known to result in high shark catch rates would reduce shark interactions. About half (43%) of respondents replied that these strategies

would not be effective since shark interactions occur even when not using bait types typically employed for shark capture. Of these, four respondents (10%) believe artificial bait would not be economically viable for mahi mahi capture since bait type for this target species is captured fresh before the setting of the longline. Seven respondents (17%) replied that they do not know if these strategies would be effective. One respondent replied that he had used artificial bait but still had shark interactions.

#### **A6.13.6. Reducing injury to hooked sharks that you will discard**

Over a third (34%) of respondents discard live sharks below 40-60 cm in length. Some respondents (7.1%) noted that small sharks that are to be discarded are easy to dehook. If the shark is hooked in the mouth this can be done manually without using any tools. If a shark is small but has swallowed the hook it will be killed and retained. These respondents also believe that the use of dehookers could reduce injury to hooked sharks that are to be discarded. One respondent replied that with training he could use dehookers. Most respondents had not heard of or knew about dehookers. Two respondents replied that they used dehookers to recover hooks but that they did this once the sharks were on board and dead.

#### **A6.13.7. Reducing shark retention by avoiding a specific size or type of hook, or by not using wire leaders on branch lines**

Only one respondent (4.2%) replied that the size of the hook would affect the shark catch rate. Most respondents (69%) replied that shark retention is reduced by not using a wire leader on their branch lines. Respondents use nylon monofilament only because they believe that using wire leaders would decrease their target species capture during the summer. Wire leaders are used during shark season to increase shark capture.

#### **A6.13.8. Will the economic impact of sharks be reduced from using a wire leader on branch lines**

Most respondents believe that the economic impact of sharks would be reduced by using a wire leader on branch lines. Even though most of them find it economically beneficial to capture sharks, they will not switch to using a wire leader because it would reduce mahi mahi capture which is more abundant and easily available at summer time.

#### **A6.13.9. What is the most important factor that affects shark CPUE - altering fishing position in relation to certain water temperature, topographic features, or oceanographic features; changing the time of day or month of setting or hauling; changing the depth of hooks, or a combination of these factors?**

Thirty-eight percent of respondents believe that altering fishing position in relation to certain water temperatures alone will result in a high shark catch rate. Over half of respondents (57%) replied that a combination of different factors result in a high shark catch rate. The majority of these respondents (63%) did not specify these factors. While 17% replied that altering fishing position and setting their gear deeper will increase shark CPUE, 13% of respondents mentioned that time of month was also an important factor along with altering fishing position. One respondent considered the important factors affecting shark CPUE to be time of the month together with setting gear deeper. Another respondent mentioned a combination of three factors (altering fishing position, setting gear deeper, and time of the month) as the most important parameters affecting shark CPUE. Respondents based their answer on their fishing practices during the shark season.

### **A6.14. Incentives and Attitudes on Reducing Shark Bycatch and Depredation**

Almost three quarters (71%) of respondents indicated that they are not interested in reducing shark bycatch. Over half (62%) of respondents noted that they are interested in reducing shark depredation. The most common reason mentioned for not wanting to reduce shark interactions was because of the high value for sharks. Only a few respondents replied they would not mind avoiding shark interactions. This was due to the lower prices paid for sharks during mahi mahi season. Loss of gear and time spent repairing gear were mentioned as the main reasons why respondents would be interested in reducing shark depredation. Among the reasons why some respondents (12%) were not interested in reducing shark depredation were: (i) loss of gear expenses are already taken in account for every trip and are paid by owner, and (ii) catching sharks is profitable.



Over a third (40%) of respondents believes that, in the absence of restrictions on finning, shark bycatch during mahi mahi season would lead to declines in shark populations. Another third (36%) of respondents believe it would not lead to a decline, while the remaining respondents did not know. Reasons provided by those who believe bycatch during mahi mahi season would mean the decline of shark population were: (i) summer acts as a temporal reduction in shark capture, which aids population growth, and (ii) because people do not respect minimum capture sizes. Given that shark captures are not as high as they used to be, fishermen now tend to retain every shark that gets hooked. Those respondents who believe shark bycatch during the summer would not lead to a decline in shark populations stated that there are not many shark interactions during mahi mahi season to impact populations and that the main reason for shark population declines is interactions with industrial fisheries and the finning they perform.

About 62% of respondents stated that their general feelings about sharks are that they are economically important. For them, sharks primarily mean revenue and livelihood. One respondent mentioned that shark work is very hard during shark season and they should be better compensated. Only five (12%) respondents stated that sharks should be under a sustainable management program. These respondents believe that shark populations have declined within the past years, and penalties, bans, and more controls over minimum size limits should be enforced for conservation purposes.

### A6.15. Supporting Figures

Figs. A6.5 – A6.10 provide images of the fisheries described in this contribution.



Fig. A6.5. A typical artisanal longline vessel from the port of Ilo.



Fig. A6.6. The bustling longline port of Ilo in southern Peru.



Fig. A6.7. View of a multifilament longline of an artisanal vessel.



Fig. A6.8. Stored mainline in stern of fishing vessel. Note the mainline with integrated floats and the wood planks holding hooks to the right.



Fig. A6.9. Shark carcasses being finned at port.



Fig. A6.10. Shark carcasses being cleaned at port.

## A6.16. References

- ALFARO, J. and J. MANGEL. 2002. Pilot project to Monitor the Longline Shark Fishery in Peru. Final Report for Duke University, March 2005.
- BONFIL, R. 1994. Overview of world elasmobranch fisheries. FAO Fisheries Technical Paper 341. Rome, FAO. 125 pp.
- CATARCI, C. 2004. World markets and industry of selected commercially-exploited aquatic species with an international conservation profile. FAO Fisheries Circular. No. 990. Rome, FAO. 2004. 186p.
- DIARIO OFICIAL EL PERUANO. 2001. Aprueban relacion de tallas minimas de captura y tolerancia maxima de ejemplares juveniles de principales peces marinos e invertebrados. Resolucion Ministerial N° 209-2001-PE. Año XIX, Nro.7675 (27 Junio 2001), p. 205170-205171.
- ESCUADERO, L. 1997. Encuesta estructural de la pesqueria artesanal del litoral peruano. Informe Progresivo del Instituto del Mar del Peru 59: 1-87.
- ESTRELLA, C. and GUEVARA-CARRASCO, R. 1998a. Informe estadístico anual de los recursos hidrobiológicos de la pesca artesanal por especies, artes, caletas y meses durante 1996. Instituto del Mar del Perú. Informe no.131, Marzo 1998. La Punta, Callao. 222pp.
- ESTRELLA, C. and GUEVARA-CARRASCO, R. 1998b. Informe estadístico anual de los recursos hidrobiológicos de la pesca artesanal por especies, artes, caletas y meses durante 1997. Instituto del Mar del Perú. Informe no.132, Marzo 1998. La Punta, Callao. 422pp.
- ESTRELLA, C., GUEVARA-CARRASCO, R., and PALACIOS, J. 1998. Informe estadístico de los recursos hidrobiológicos de la pesca artesanal por especies, artes, caletas y meses durante el primer semestre de 1998. Instituto del Mar del Perú. Informe no.139, 229 pp.
- ESTRELLA, C., GUEVARA-CARRASCO, R., and PALACIOS, J. 1999a. Informe estadístico de los recursos hidrobiológicos de la pesca artesanal por especies, artes, caletas y meses durante el segundo semestre de 1998. Instituto del Mar del Perú. Informe no.143, Febrero 1999. La Punta, Callao. 226pp.
- ESTRELLA, C., GUEVARA-CARRASCO, R., PALACIOS, J., AVILA, W., and MEDINA, A. 1999b. Informe estadístico de los recursos hidrobiológicos de la pesca artesanal por especies, artes, meses y caletas durante el primer semestre de 1999. Instituto del Mar del Perú. Informe no.148, Agosto 1999. La Punta, Callao. 214pp.
- ESTRELLA, C., GUEVARA-CARRASCO, R., AVILA, W., PALACIOS, J., and MEDINA, A. 2000. Informe estadístico de los recursos hidrobiológicos de la pesca artesanal por especies, artes, meses y caletas durante el segundo semestre de 1999. Instituto del Mar del Perú. Informe no. 151, Enero 2000. La Punta, Callao. 194pp.
- ESTRELLA, C., CASTILLO, G. and FERNANDEZ, J., 2006. II Encuesta Estructural de la Pesquería Artesanal Peruana. Regiones de Moquegua y Tacna.
- FAO FISHERY INFORMATION, DATA and STATISTICS UNIT. 2006. Fisheries commodities production and trade 1976-2004. FISHSTAT Plus - Universal software for fishery statistical time series

- [online or CD-ROM]. Food and Agriculture Organization of the United Nations. Available at:  
<http://www.fao.org/fi/statist/FISOFT/FISHPLUS.asp>
- JAHNCKE, J., GOYA, E. and GUILLEN, A. 2001. Seabird bycatch in small-scale longline fisheries in Northern Peru. *Waterbirds* 24(1): 137-141.
- LEY GENERAL DE PESCA. 2001. Decreto Supremo N° 012-2001-PE.
- MINISTERIO DE PESQUERIA. 2000. Agenda pendiente, Un mar de oportunidades.
- MANGEL, J. and J. ALFARO- SHIGUETO. 2004. Seabird bycatch in Peruvian artisanal fisheries: Results from fishermen surveys. Oral presentation at the 3rd International Albatross and Petrel Conference, Montevideo, Uruguay, August.
- VANNUCCINI, S. 1999. Shark Utilization, Marketing and Trade. FAO FISHERIES TECHNICAL PAPER 389, Rome, 1999.
- PROMPEX, COMISION PARA LA PROMOCION DE EXPORTACIONES. On-line information. May 2006. [www.prompex.gob.pe](http://www.prompex.gob.pe).
- REYES, J.C., 1993. Reintroduction of Longlines in the Peruvian Shark Fishery: An Alternative to Reduce Small Cetacean Mortality. Final report for the Cetacean Specialist Group, Species Survival Commission of the International Union for the Conservation of Nature and Natural Resources IUCN, and the Whale and Dolphin Conservation Society WCS. pp 30.

## Appendix 7

### South Africa Pelagic Longline Tuna and Swordfish Fishery: Industry Practices and Attitudes towards Shark Depredation and Unwanted Bycatch

**Samantha Petersen and Meidad Goren, BirdLife South Africa,  
Seabirds@birdlife.org.za**

#### A7.1. Introduction

The oceanic and inshore waters surrounding South Africa are frequented by 36 species of sharks that are classified as threatened, near-threatened or data-deficient by the IUCN (IUCN redlist). Nineteen of these species are threatened by either directed fishing operations or due to bycatch on other fisheries, eight of which longline bycatch is a known threat. These include the Thresher Shark *Alopias vulpinus*, Great Hammerhead *S. mokarran*, Scalloped Hammerhead *S. lewini*, Smooth Hammerhead *S. zygaena*, Shortfin Mako *Isurus oxyrinchus*, Blue Shark *Prionace glauca*, Porbeagle Shark *Lamna nasus* and Crocodile Shark *Pseudocarcharias kamoharai*. However, little is known of the scale of this threat in South Africa's pelagic fishery.

#### A7.2. Data Sources

Observer data from South Africa flagged vessels, collected and analyzed from 2000 to 2005, are used for analyses in this study. Observers were only placed on foreign flagged vessels in 2005 and thus data only from this year are available for analysis. We conducted ten interviews all with captains and crew of South African flagged vessels, as no foreign vessels have been operating in South African waters since the commencement of this study.

#### A7.3. History of the Fishery and Effort Trends

The earliest record of a South African domestic pelagic longline fishery dates back to the early 1960s. This fishery predominantly targeted Albacore *Thunnus alalunga*, Southern Bluefin *T. maccoyii* and Bigeye *T. obesus* tunas (Cooper and Ryan, 2005). Effort waned in the domestic fishery in the mid 1960s, as interest shifted to more lucrative fisheries.

Thereafter, pelagic fishing effort was largely conducted by Japanese and Taiwanese vessels as part of a bilateral agreement (Fig A7.1). These Asian vessels set their gear relatively deeply, frequently set during the day, seldom used lightsticks and primarily targeted tuna spp. Their fishing effort accounted for 96% of the c. 12 million hooks set annually within the South African EEZ during 1998-2000 (Ryan and Boix-Hinzen, 1998, Ryan et al., 2002).

In 1995 a permit was issued to conduct a joint venture operation between a South African and Japanese vessel. This joint venture showed that tuna and swordfish could be profitably exploited in South African waters. Consequently, the directorate Marine and Coastal Management issued 30 experimental permits in 1997 to South African flagged vessels. These vessels set their gear relatively shallow, used light sticks and set their lines at night and primarily caught swordfish (Fig. A7.2).

All foreign licences were revoked in 2002. This has resulted in a smaller and domestic fishery operating in South Africa's Exclusive Economic Zone (EEZ) targeting primarily swordfish. However, the domestic fishery was further developed in 2004 when 50 commercial fishing rights were made available for allocation (30 tuna and 20 swordfish). Twenty six rights (11 Korean, 2 Philippine and 4 South African flagged vessels; remaining permits under ship building contracts) were allocated to vessels fishing for tuna and 17 for those fishing for swordfish (15 South African, 1 Belize and 1 Australian flagged vessel) in March 2005. These foreign vessels were operating under joint venture contracts with South African companies. Their effort is recorded separately because they operate differently to the South African vessel as detailed above (Fig. A7.3).

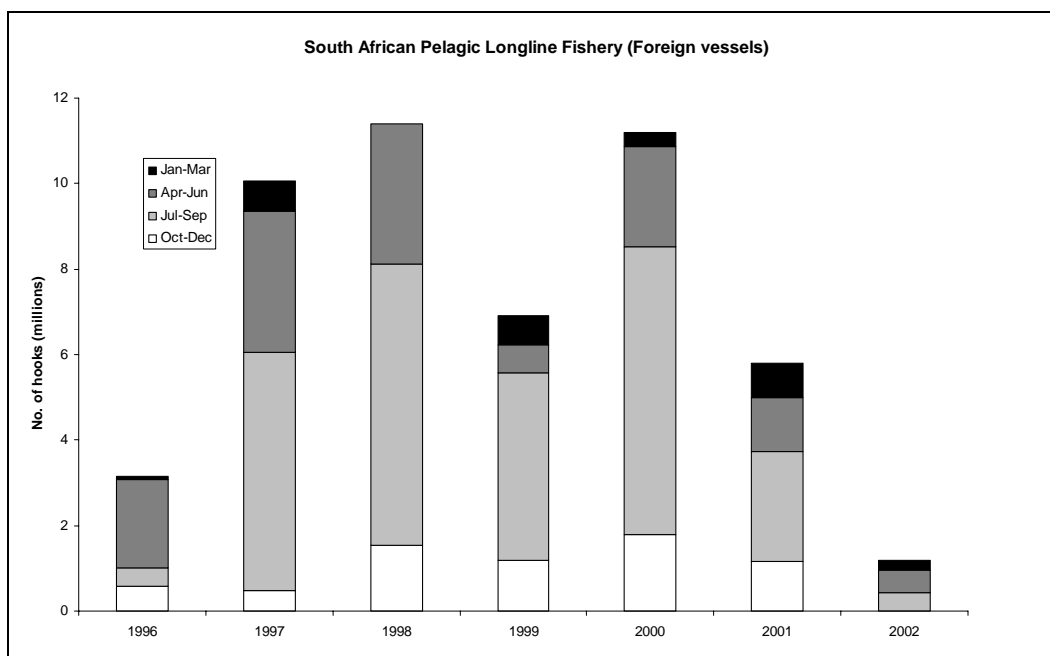

Fig. A7.1. Fishing effort by foreign vessels (Japanese and Taiwanese) operating in South African pelagic longline fishery (1996-2002) under bilateral agreement.

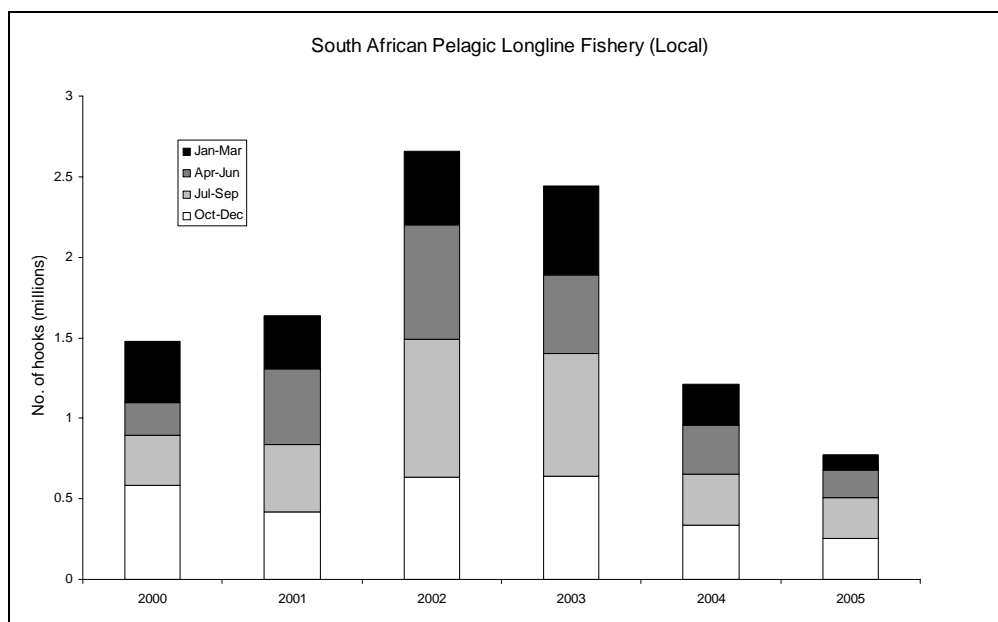

Fig. A7.2. Fishing effort by domestic vessels operating in South African pelagic longline fishery (2000-2005).

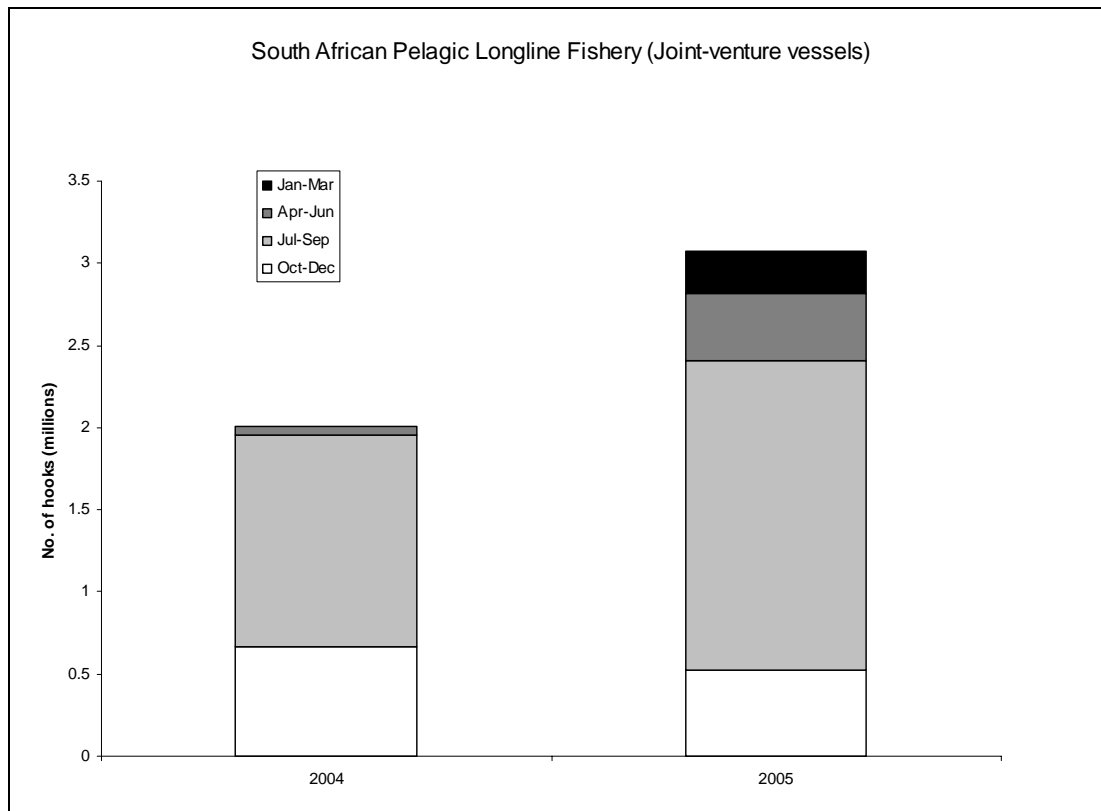

Fig. 3. Fishing effort by foreign vessels operating under joint-venture agreements in South African pelagic longline fishery (2004-2005).

#### A7.4. Fishing Gear and Operations

There are two distinct pelagic or surface longline gear configurations used in South African waters based on whether the target species is swordfish or tuna. To target swordfish the hooks are generally set shallow (seldom deeper than 40 m) by using short buoylines and branchlines and no line setter. In general lightsticks are also used. This gear configuration generally characterizes the South African domestic fleet. Those that target tuna set the hooks deep (often deeper than 200 m) by using a line setter and long buoylines and branchlines. Lightsticks are seldom used. This gear configuration is generally employed by the Japanese and Taiwanese fleets.

There were on average 17 (range 1-26) vessels in the domestic fleet between 1997-2003. Thirty vessels carried an observer at least during this time period. This description of the fishery is derived from this subset of the fleet ( $n=615$  sets on 70 trips) as well as information provided in interviews. Sampled vessels vary in size (average 31 m, range 19-56 m, std dev 7.9 m) and carry an average of 18 (range 6-31, std dev 5) crew members. Trips ( $n=70$ ) are on average 14 (range 5-38, std dev 5.8) days.

In general a mainline, which could be over 50 miles, is usually made of monofilament nylon. It is usually set between late afternoon and midnight (43% set in the dark, 2% in the light and 55% during twilight) and is allowed to soak until dawn (note: dark/light = start to finish in the dark/light, twilight = start in the dark or light and end in the other). The line is kept close to the surface by numerous buoys which are attached to the mainline via buoylines at an average of 194 m (range 46-370 m, std dev 108) apart and are on average 20 m (range 10-37 m, std dev 3 m) long. Additional radio or light buoys are also used to locate the line. There are between 20 and 472 (average 272, std dev 100) buoys on a line and on average five (range 3-30, std dev 3) branchlines or snoods between buoys. On average 1300 (range 1000-2500)

hooks are attached to the mainline the branchlines. Branchlines are spaced evenly along the mainline at an average of 42 m (range 17-65 m, std dev 15) apart. A typical South African flagged pelagic longliner makes up their branchline to the following specifications (Table A7.1): an upper section of approximately 18 m, a swivel (usually 60-80g) and a lightstick and then a lower section of approximately 2 m ending in a baited hook.

Eighty nine percent of observed vessels used squid as bait, with the remaining 11% using a combination of squid and between 8-75% fish bait (pilchard, mackerel). This is consistent with interview results. None was recorded using live bait. According to observer data 23% of vessels did not use light sticks (most likely those targeting tuna), 5% used light sticks on less than 50% of their branchlines, 3% used light sticks on 50% of their branchlines, 12% used light sticks on between 51-99% of their branchlines and 57% used light sticks on 100% of their branchlines. All those interviewed said they always use light sticks. 10% of observed vessels used a line setter. In general the line is set at an average speed of 8 knots.

Table A7.1. Description of fishing gear.

<b>Fishing Gear and Method</b>	<b>South African Vessels</b>	<b>Asian Vessels</b>
Trip duration	10-15 days	45 days (usually longer when observers not on board)
No. of sets per trip	8-15 sets	40 sets
No. of trips per year	Variable	Most of the year
Fishing grounds	Mainly on continental shelf off the West coast and northeast coast	Mainly on Agulhas Bank & continental shelf on East coast
Fishing season(s)	All year	All year
Mainline material	Mainly Monofilament nylon	Mainly Monofilament nylon
Mainline length	50 miles	
Mainline deployment	Stern	Stern
Distance between buoys	200 meters	
Distance from buoy to mainline (float line length)	20 meters	
Average branch line length	20 meters (2 sections)	38 meters (3 sections)
Branch line material	Mainly Monofilament	Multi- & Monofilament & braid with lead core
Wire trace or leader on branch lines	Not permitted	Not permitted
No. of hooks between buoys	5	
Average maximum depth of hooks when set	60-70 meters	
Average maximum depth of mainline when set	40-50 meters	
Branch line sink rate	0.24m/sec (with 60g)	0.12m/sec (no weight)
Timing of set	43% dark, 2% light, 55% twilight	43% dark, 2% light, 55% twilight
Lightstick use	Yes	No
Number of hooks per set	1000-1500	1000-2500
Hook setting interval	40 meters	
Radio beacons	Yes	Yes
Hook type	J hook	J hook
Weight size and location	60-80 grams swivels 2 meters above the hook	None
Clip size and type	Snap-Jap 3.8 x 130	
Bait type	Mainly Squid	Squid and fish (e.g. Sardine)
Number of crew	Average of 18	Average of 20
Vessel Monitoring System	Yes	Yes



## A7.5. Shark Bycatch Composition and Catch Rates

### A7.5.1. Catch composition

Blue Sharks were the most common species caught (average 69% of shark catch, range over time period 63–79%), then Mako Sharks 17% (8–20%) with the remaining 14% (5–29%) being made up of primarily Bronze Whaler, Cookie Cutter, Crocodile, Dusky, Oceanic Whitetip, Porbeagle, Thresher, Bigeye Thresher, hammerheads and Zambezi Sharks (Table A7.2). Blue Sharks were retained in 72% of cases, released alive in 18% of cases, finned and discarded (dead) in 5% and unknown for the remaining 4%. The discarded animals were often finned. Observers reported 30% and 25% of Blue Shark catches were finned in 2000 and 2001, respectively. Mako Sharks were also frequently caught and most commonly the whole shark was retained (86%). 10% were released alive and 2% discarded after finning. Thresher Sharks were infrequently caught and equally discarded/released and retained. The Bronze Whaler was infrequently caught, but when it was caught it was usually retained. Crocodile, Cookie Cutter, Dusky (likely to include misidentified Silky Sharks (*C. falciformis*), Oceanic Whitetip, Dog Tooth, Bigeye Thresher, hammerhead spp. and Porbeagle sharks were infrequently caught, but almost always discarded/released. Even though the Crocodile Shark was caught infrequently, there were some occasions when they were caught in large numbers (e.g. a maximum of 81 was caught in a single set). The Zambezi Shark was rarely caught and in both cases it was discarded or released. Observers did not record whether sharks were hauled onboard dead or alive.

Table A7.2. Shark bycatch composition, 1998-2005.

Common Name	Scientific Name	Composition by Number of Total Shark Catch
Blue shark	<i>Prionace glauca</i>	69.2%
Short-fin Mako shark	<i>Isurus oxyrinchus</i>	17.2%
Crocodile shark	<i>Pseudocarcharias kamohari</i>	4.2%
Bronze Whaler shark	<i>Carcharhinus brachyurus</i>	2.6%
Thresher shark	<i>Alopias vulpinus</i>	2.2%
Thresher Big eye shark	<i>Alopias superciliosus</i>	0.3%
Oceanic white tip shark	<i>Carcharhinus longimanus</i>	1.2%
Dusky shark	<i>Carcharhinus obscurus</i>	0.5%
Silky shark	<i>Carcharhinus falciformis</i>	0.5%
Porbeagle	<i>Lamna nasus</i>	0.3%
Smooth Hammerhead	<i>Sphyrna zygaena</i>	0.2%
Scalloped Hammerhead	Shark <i>Sphyrna lewini</i>	0.2%
Great Hammerhead	<i>Sphyrna mokarran</i>	0.2%
Cookie cutter shark	<i>Isistius brasiliensis</i>	0.1%
Zambezi shark	<i>Carcharhinus leucas</i>	0.03%
Bigeye Sixgill shark	<i>Hexanchus nakamurai</i>	0.01%
Soupfin shark	<i>Galeorhinus galeus</i>	0.01%
Lanternshark	<i>Etmopterus</i> spp	0.01%
Hardnose houndshark	<i>Mustelus mosis</i>	0.004%
Tiger shark	<i>Galeocerdo cuvier</i>	0.004%
Unidentified		1.1%

Table A7.3. Shark catches, effort and catch rates 1998 - 2005

	1998	1999	2000	2001	2002	2003	2004	2005	Total
Total hooks	472,104	516,919	1,476,807	1,637,358	2,658,127	2,440,069	5,098,196	7,538,265	21,837,845
Observed hooks	73,859	27,385	73,859	281,206	301,831	188,542	139,430	3,230,257	4,316,369
% observed of total	16%	5%	5%	17%	11%	8%	3%	43%	20%
Swordfish	493	608	493	2343	2944	1836	319	3064	12100
Tuna	1746	380	1746	4067	3891	3179	2250	84928	102187
Total Catch	3472	1606	3472	11102	12141	8473	5192	114478	159936
Blue shark	611	443	611	1914	2080	1546	1722	9014	17941
Short-fin Mako shark	180	66	180	478	238	236	142	2944	4464
Crocodile shark	18	9	18	57	619	59	190	117	1087
Bronze Whaler shark	3	20	3	377	139	61	35	27	665
Thresher shark	8	1	8	19	90	20	15	422	583
Shark unidentified	0	0	0	1	103	75	137	141	457
Oceanic white tip shark	125	0	125	4	19	27	12	9	321
Dusky shark	3	0	3	0	42	26	31	28	133
Thresher Big eye shark	10	3	10	0	0	18	0	33	74
Porbeagle	1	0	1	4	44	18	0	4	72
Hammerhead sharks	0	0	0	3	44	0	0	0	47
Cookie cutter shark	0	0	0	0	1	18	0	0	19
Zambezi shark	0	0	0	1	1	0	4	1	7
Bigeye Sixgill shark	0	0	0	0	0	0	0	3	3
Soupfin shark	0	0	0	0	3	0	0	0	3
Lanternshark	0	0	0	0	0	0	0	2	2
Hardnose houndshark	0	0	0	0	0	0	0	1	1
Houndshark Unidentified	0	0	0	0	0	0	0	1	1
Tiger shark	0	0	0	0	0	0	0	1	1
Total Sharks	959	542	959	2858	3423	2116	2289	12785	25931
Number sharks catch per 1000 hooks	13.0	19.8	13.0	10.2	11.3	11.2	16.4	4.0	6.0

The catch rate of sharks averaged 6.0 sharks per 1000 hooks and ranged between 4 and 19.8 during 1998-2005 (Table A7.3). Blue sharks were caught on average at a rate of 4.2 blue sharks per 1000 hooks and Short-fin Makos at a rate of 1.0 per 1000 hooks (1998-2005) (Table A7.3).

Seasonal differences in catch rates were found for all species caught in substantial numbers (Blue  $X^2 = 1026.2$ , Mako  $X^2 = 190.8$ , Crocodile  $X^2 = 525.5$ , Bronze Whaler  $X^2 = 78.5$ , Dusky  $X^2 = 101.5$ , Hammerhead  $X^2 = 54.7$ , Oceanic Whitetip  $X^2 = 29.8$ , Porbeagle  $X^2 = 105.7$ ,  $p < 0.001$ ,  $df = 3$ ). Blue and Mako Sharks were caught throughout the year, but catch rates were the highest in winter (Fig. A7.4). Bronze Whaler, Crocodile and Oceanic Whitetips were predominantly caught in summer. Hammerhead sharks were predominantly caught in autumn. Bigeye thresher sharks were the most commonly caught in winter. Dusky, Porbeagle and Thresher sharks were predominantly caught in spring (Fig A7.4).

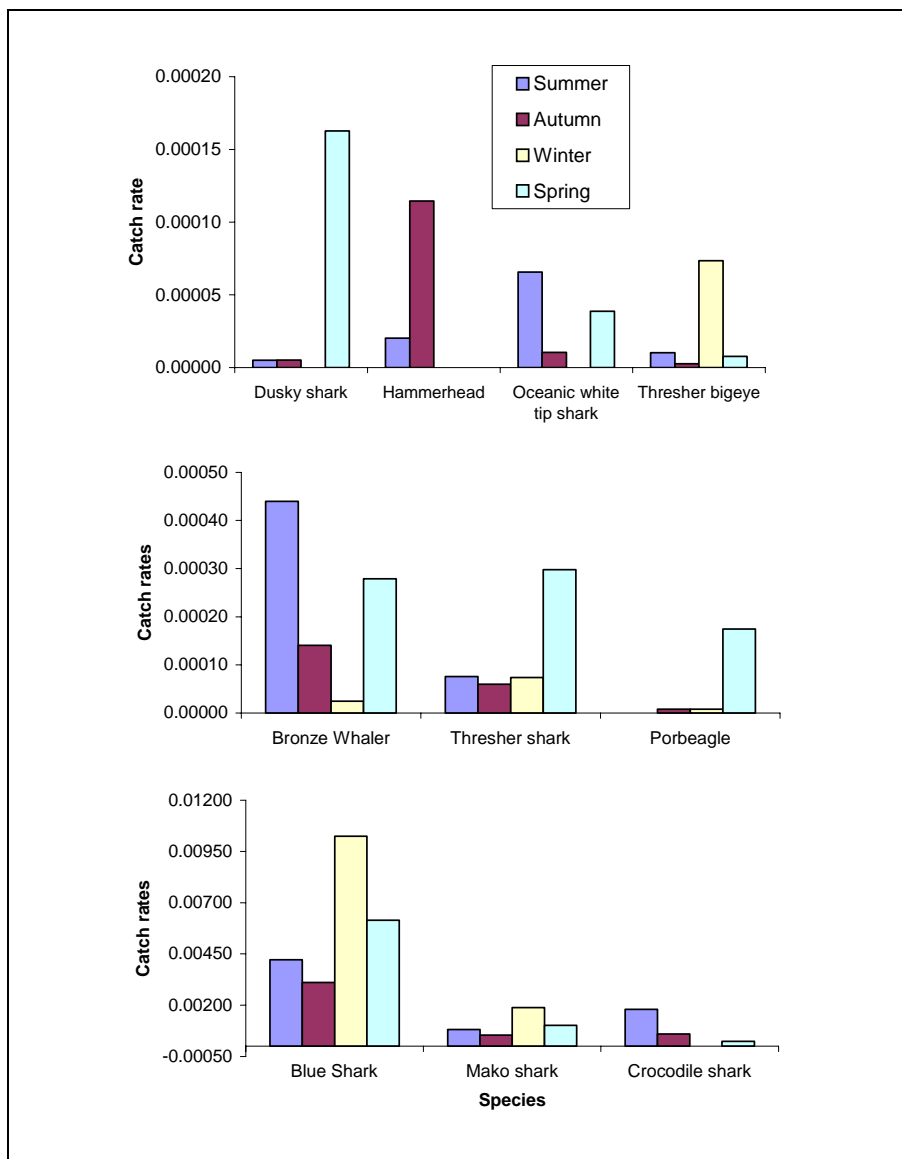

Fig. A7.4: Seasonal distribution of shark bycatch catch rates (note different scales on y-axis).

Sharks were caught on every set. Blue sharks were caught on most (87%) of sets (Fig. A7.5). Mako catches showed a tendency to be caught on the western and south western coast (Fig. A7.6). Oceanic Whitetip, hammerhead and dusky (although this is likely to include mis-identified silky sharks) were mainly caught off the KwaZulu-Natal (KZN) coast. Threshers were also mainly caught off the KZN coast although a few were caught off the western and south-western cape. Bigeye threshers and Porbeagle sharks were caught off the western and south-western cape. Crocodile, Cookie Cutter and Bronze Whaler sharks were caught off the west and KZN coasts.

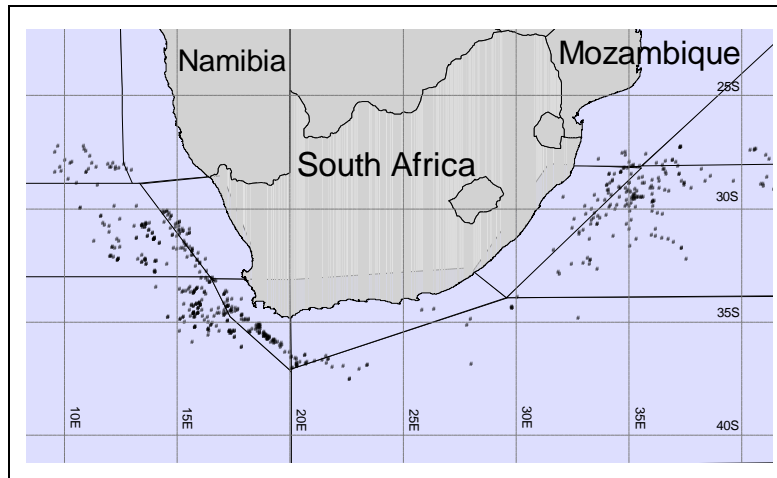

Fig. A7.5. Distribution of sets on which Blue Sharks were caught, 2000-2003.

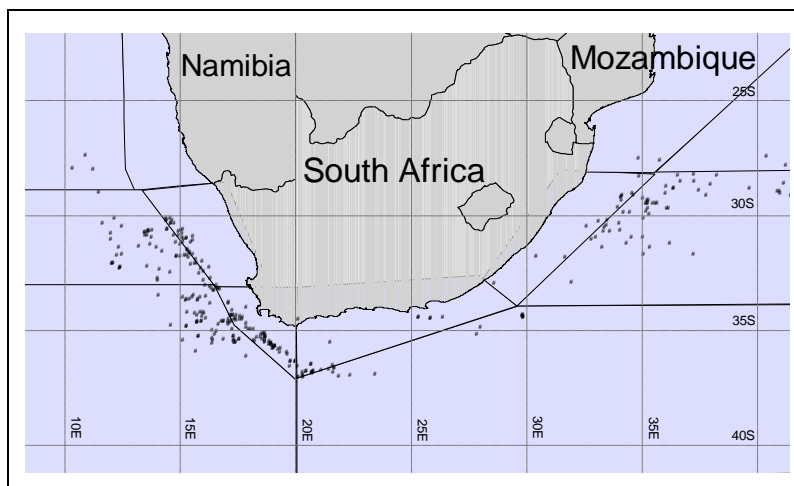

Fig. A7.6. Distribution of sets on which Mako Sharks were caught, 2000-2003.

#### A7.5.2. Perception of interviewees

Skippers interviewed were of the opinion that they catch 10 to 20 sharks or between 100 and 300 kg of sharks per set. Most felt the blue shark was the most commonly caught at a rate of up to 15 blue sharks (or 200 kg) per set. They usually retain most blue sharks (within the regulations). They report that blue sharks are usually hauled aboard alive, but die if they become badly entangled in their gear. Most felt that this capture had no effect on the species, however one skipper felt that the capture of blue sharks was dramatically threatening the species. The second most common species caught in their opinion was the short-fin mako shark. Up to 10 makos are caught per set and this comprises approximately 20 to 100 kg. They usually retain all makos (again within the regulations). The economic value of makos is higher than for blue sharks and thus retained more frequently. Most makos are alive on capture, but a portion of them are dead. Most felt that this capture had no effect on the species, however the same skipper as above felt that the capture of makos was dramatically threatening the species. Two of the skippers interviewed felt that shark bycatch was not causing any economic loss to the fishery. Three felt it was causing economic loss due to loss of bait and time. The remaining did not know. Only half said that they submitted their shark catches in their logbook records.

#### A7.6. Management Framework Relevant to Shark Interactions

At present there are no accepted mitigation measures for reducing shark bycatch and this requires investigation. South Africa has a draft NPOA-sharks, but this has not yet been adopted. However, in order to address mounting international concern for high levels of shark bycatch, Marine and Coastal Management, Department of Environmental Affairs and Tourism, South African Government, have planned to close the pelagic sector of

the shark-directed longline fishery and place a 10% shark bycatch limit on the tuna and swordfish fishery. Since 2005 this fishery has been divided into those targeting swordfish and those targeting tunas. Individuals with a swordfish permit may only land sharks up to a maximum of 10% of their swordfish and tuna catch. Individuals with a tuna permit may only land sharks up to a maximum of 10% of their tuna catch. Currently shark bycatch accounts for approximately 18% or 25% of the directed catch (Table A7.4). This is substantially larger than the suggested 10%, thus many of these shark species will be released or discarded. Since we have no estimate of post-release survival nor adequate information on the percentage of species hauled alive, this may not be sufficient to address mounting concerns.

Shark finning regulations came into effect in South Africa in 1998 under the Marine Living Resource Act of 1998 (MLRA, 1998). Regulations formed under this act banned finning. The South African experimental pelagic longline fishery only commenced in 1997 and thus very little information exists on finning practices in this fishery. Under this regulation sharks were supposed to be landed whole, which would mean that no finning was allowed. However, fishers complained that it was impractical to land sharks whole. Marine & Coastal Management gave concession for fishers to land the fins with the corresponding trunks, but this was not enforced as result sharks were definitely finned during this time. A 5% fin to carcass ratio was introduced last year (2005) in an attempt to stop finning. Further regulations prohibit the use of a wire trace to limit the retention of shark catches in this fishery.

Table A7.4. Shark bycatch as a proportion of total catch.

Year	Hooks	Swordfish	Tuna	Tuna & Swordfish	Total Sharks	% sharks of Tuna	% of T & S
1998	27385	608	380	988	959	252%	55%
1999	184864	1225	4628	5853	542	31%	25%
2000	73859	493	1746	2239	959	55%	43%
2001	281206	2343	4067	6410	2858	70%	45%
2002	301831	2944	3891	6835	3423	88%	50%
2003	188542	1836	3179	5015	2116	67%	42%
2004	139430	319	2250	2569	2289	102%	89%
2005	4316369	3064	84928	114478	12785	15%	15%
<b>Total</b>	<b>5513486</b>	<b>12832</b>	<b>105069</b>	<b>144387</b>	<b>25931</b>	<b>25%</b>	<b>18%</b>

#### **A7.7. Economic, Social and Ecological Effects, Including Effects on Fishing Practices, from Regulations Governing Shark Interactions**

The total amount and condition of sharks landed is limited by the regulations discussed above. Most of the fishers that were interviewed felt that the 10% regulation was hard to comply with because it doesn't reflect the reality. In many cases they catch more than their 10% and are thus forced to dump or discard dead sharks (Table 4). They felt it is also problematic because it results in the underreporting of shark catches. Three interviewees said that this regulation had minimal economic impact on them, two said that it caused great economic loss, but was unable to quantify and the remaining didn't know. When revenue is acquired from finning this typically goes to the crew and/or skipper. In some cases these vessels are owner-operator and thus revenue is accrued to the company. One skipper reported that they don't fin at all on his vessel because he doesn't approve of the practice. The crew occasionally will retain the jaw of large makos. This will be dried and sold for their own revenue.

Most felt that finning regulations were effective. 60% felt that if there were no regulation regarding finning then the practise would threaten the status of shark populations. Since the 10% regulation has been adopted they now only retain 10%, whereas before they would possibly have retained more depending on space availability, current prices etc.

They all said that they have altered their fishing practices since the regulations have been adopted. Before the adoption of the finning regulations they would fin and dump most carcasses with the exception of makos which were retained for their flesh.

### **A7.8. Practices to Deal with Caught Sharks**

Most skippers interviewed try to bring the shark alongside the vessel, then cut the line as short as possible and release the shark with the hook in its mouth. Many however will go to great lengths to retrieve their hook often at the expense of the shark. If the shark is small enough then they will land it, de-hook and release or discard. A de-hooker is never used mainly because they don't have one onboard and thus have never tried to use one. The decision as to whether they will retain or discard is usually based on the following: a) its size i.e. if it is too small they will usually discard, b) if their target catch is good they will discard (i.e. limited space availability) and c) regulations restricting them to 10% of their target catch. One interviewee was concerned about the safety of his crew and thus did not land large, live sharks. Product contamination was also a concern for half of the skippers interviewed.

### **A7.9. Methods for Onboard Processing of Retained Sharks**

There are two common methods for onboard processing of retained sharks by vessels in the domestic South Africa longline fishery: (i) Retaining the body, fin the shark and discard the rest; and (ii) retaining the whole body. Foreign licensed vessels generally retain fins and trunks, and discard heads and guts of sharks.

### **A7.10. Shark Depredation and Gear Damage**

For most, shark damage to their gear is a concern and estimated about at R5000 (approximately 750 US\$) per set ranging from R100 to R10 000 (150-1500 US\$) per set. This cost is mainly a combination of time loss and gear costs. Some of the skippers refer to the high cost of bait that is taken by sharks and some refer to the time of handling the shark on board to retain the hooks. They typically lose between 10 to 30 hooks or branchlines per set. Although this varies greatly from set to set. Approximately 2 to 5 (one skipper reported up to 15 per set) fish are typically damaged or lost to sharks on a typical set. They feel that they can tell shark damage from cetacean damage by the following: killer whales usually leaves the head and the bite mark is jagged whereas sharks bites the tail and the bite is clean. Blue and short-fin makos are the most destructive sharks, but they are also the most commonly species caught. Most (one disagreed) felt that high shark catches reduced the catch rate of the target species.

Some felt that they wanted to decrease their shark capture because they damage their gear and waste their time, others are interested in catching anything as long as it increases their profit. They would all like to decrease shark depredation although they feel cetacean depredation is a far bigger problem.

### **A7.11. Practices Employed to Reduce Shark Capture**

All skippers interviewed say that they would avoid shark capture altogether if they could as a result of the current regulations. However, if they were free to fin or retain as many sharks as they like, half said that they would not avoid catching sharks. Under this scenario shark capture would be an economic advantage. Two felt that the economic value of their shark catches is so low that it wouldn't make a difference. One skipper said that he would prefer to avoid catching sharks as their target catch was more economically advantageous.

Most felt that regulations did not give them a greater incentive to avoid shark capture. When asked how they would avoid shark capture most said that they would move out of an area where high catch rates were experienced. Most said that they do this voluntarily when high catch rates are experienced. One said that he would do nothing to avoid shark capture. They did not perceive moving to a new area to be a high cost. Some said that they would avoid shark areas except if target catch was high.

None of them said that they change their hauling practice to avoid shark depredation or capture.

No method other than the move-on rule has been tried. One skipper suggested discarding of offal should only take place once hauling is complete. In their opinion there are no other methods worth trying.

They mostly felt it would be possible to avoid peak areas and times of shark abundance. All thought that it is possible to reduce the detection of baited hooks by sharks by refraining from chumming during the set and not discarding offal and spent bait during the haul. All felt that you can't limit shark access to baited hooks by altering fishing practices to consider deployment depth of hooks and timing of the soak and haul to avoid problematic shark species. They don't think that it's possible to deter sharks such as with chemical or electrical deterrents. There was mixed opinion whether the attractiveness of baited hooks could be reduced to sharks by using artificial baits, by using light sticks, or by avoiding a bait type known to result in high shark catch rates. All thought that you can reduce injury to hooked sharks that you will discard by using a dehooker. There was mixed opinion whether shark retention on hooks would be reduced by avoiding a specific size or type of hook. All thought that you will not reduce the economic impact on sharks from using a wire leader on branch lines.

Most of the Skippers don't give much of a thought to the issue as there are no methods known to them. At the end of the day if there is good fishing and big numbers of sharks the fishing will continue and the sharks will be discarded, was the general attitude.

There was a lot of variation in the answer to the question of what is considered the most important factor affecting shark catch rates. The most common answers included: fishing in colder water, fishing on topographic features (e.g. banks, shelf break), time of the month (full moon) and the depth of the hooks (shallower). They all said that they never fish deliberately to increase their shark catch.

The overwhelming sentiment was that the most practical way of dealing with the problem would be to leave an area when high catch rates are experienced.

#### **A7.12. Incentives and Attitudes on Reducing Shark Bycatch and Depredation**

Most fishermen reported that they do not consider shark bycatch in South Africa as a threat to the local populations, but they did feel shark depredation is an issue that needs addressing.

#### **A7.13. Acknowledgements**

Thank you to the Western Pacific Regional Fishery Management Council and especially Eric Gilman for their support, help and guidance on this project. Thanks too, to Meidad Goren for undertaking most of the interviews and the observers who collect the data this report is based upon.

#### **A7.14. References**

IUCN Redlist <http://www.redlist.org>

Lombard AT. 2004. National spatial biodiversity assessment: Marine component. Department of Environmental Affairs and Tourism, 2004.

Marine & Coastal Management 2005. Draft South African National Plan of Action for the conservation and management of sharks. Marine and Coastal Management, Department of Environmental Affairs and Tourism, South Africa. [www.environment.gov.za](http://www.environment.gov.za).

Tokyo Report: Report of the 2004 inter-sessional meeting of the ICCAT sub-committee on bycatches: shark stock assessment. Tokyo, Japan, 14-18 June 2004. [www.iccat.es](http://www.iccat.es)

## Appendix 8

### U.S.A. Hawaii-based Pelagic Longline Swordfish and Tuna Fisheries: Industry Practices and Attitudes towards Shark Depredation and Unwanted Bycatch

**Eric Gilman, Blue Ocean Institute, [egilman@blueocean.org](mailto:egilman@blueocean.org)**

Information from interviews of twelve fishermen of the Hawaii pelagic longline tuna and swordfish fisheries conducted between 25 January and 22 March 2006, from analyses of the Hawaii longline logbook and observer databases and from a literature review is used to describe the Hawaii pelagic longline fleet. Of the 12 interviewed fishermen, seven are owner-operators, three are captains but not vessel owners and two are crew. The 12 fishermen have been pelagic longlining between 4 and 27 years with a mean of 12.5 years, and have been longlining based from Hawaii between 2 and 27 years with a mean of 11.4 years.

#### **A8.1. Fleet Development and Characteristics**

Longline fishing in Hawaii had been conducted for many decades prior to the expansion of the fishery in the late 1980s. Hawaii longline vessels evolved from wooden pole-and-line tuna sampans, employing longlines made from rope and fishing mainly within 2 - 20 nm of the coast. By the 1930s the longline fishery was second only to a pole-and-line "aku" or skipjack fishery in landed volume of fish, and accounted for most of the yellowfin (*Thunnus albacares*), bigeye (*Thunnus obesus*) and albacore (*Thunnus alalunga*) landed in Hawaii. The fishery peaked in the mid-1950s with landings exceeding 2000 t and then declined steadily through lack of investment in boats and gear until the late 1980s. The revitalization of the Hawaii-based longline fishery was due to the development of local markets and export markets for fresh tuna from the U.S. mainland and Japan, and expansion of fishing for swordfish around the Hawaiian Islands. Participation in the longline fishery increased from 37 vessels in 1987 to 88 in 1989, and then doubled again to 141 vessels in 1991 (Table A8.1). Of a possible 164 active vessels, there were 125 active Hawaii-based longline vessels in 2005, which set 34,895,229 hooks and made 1,427 trips targeting tuna and 106 trips targeting swordfish (Table A8.1) (Clemens, 2006). Further entry to the longline fishery was halted through a moratorium in 1991, followed by a limited entry program to restrict effort. The new entrants in the longline fishery were mostly steel hulled vessels up to 110 ft in length and their operators were former participants in the U.S east coast tuna and swordfish fisheries. These newer vessels in the fishery were also characterized by a greater reliance on sophisticated electronic gear for navigation, marking deployed longline gear and finding fish. The revitalized fleet also adopted more modern longline gear, using continuous nylon monofilament main lines stored on spools, with snap-on monofilament branch lines.



Table A8.1. Effort data for the Hawaii-based longline tuna and swordfish fisheries, 1987 – 2004 (Western Pacific Regional Fishery Management Council, 2005a; Clemens, 2006).

<b>Year</b>	<b>Number of active vessels</b>	<b>Number of trips</b>	<b>Number of hooks set (millions)</b>
		Not known	Not known
1987	37	known	
		Not known	Not known
1988	50	known	
		Not known	Not known
1989	88	known	
		Not known	Not known
1990	138	known	
1991	141	1,671	12.3
1992	123	1,266	11.7
1993	122	1,192	13.0
1994	125	1,106	12.0
1995	110	1,125	14.2
1996	103	1,100	14.4
1997	105	1,125	15.6
1998	114	1,140	17.4
1999	119	1,138	19.1
2000	125	1,103	20.3
2001	101	1,034	22.4
2002	100	1,165	27.0
2003	110	1,215	29.9
2004	125	1,338	32.0
2005	125	1,533	34.9

All Hawaii longline vessels are < 30.8 m in length. Most medium and larger vessels between 17 and 30.8 m long target swordfish, while the smaller vessels  $\leq$  17 m in length target tuna (Fig. A8.1) (U.S. National Marine Fisheries Service, 2001). Vessels use ice for fish preservation, to meet market demand for fresh fish (McCoy and Ishihara, 1999).



Fig. A8.1. Hawaii pelagic longline vessels at berth in front of the Honolulu fish auction.

## A8.2. Range of Fishing Gear and Methods

Table A8.2 summarizes the general fishing methods and gear of the contemporary Hawaii-based longline tuna and swordfish fisheries. The information in Table A8.2 is intended to provide a generalized characterization of the Hawaii longline fleet. However, the longline gear configurations and fishing methods are not consistent between Hawaii vessels. For instance, the color of main and branch lines, weight amount and location, type of buoys, vessel horsepower, trip length and fishing days, vary between vessels.

Table A8.2. Fishing gear and methods of the Hawaii-based pelagic longline swordfish and tuna fisheries (U.S. National Marine Fisheries Service Pacific Islands Fisheries Science Center, Unpublished Data; Boggs, 1992; Pacific Ocean Producers, 2005; Ito and Machado, 2001; U.S. National Marine Fisheries Service, 2001; Brothers and Gilman, 2006).

<b>Fishing Gear and Method</b>	<b>Hawaii Longline Tuna Vessel</b>	<b>Hawaii Longline Swordfish Vessel</b>
Trip duration	21 days	30 days
Number of sets per trip	10	17
Number of trips per year	15	Annual swordfish effort is capped at 2,120 sets or until turtle interaction caps are reached, whichever threshold is reached first. From 1991-2001 vessels targeting swordfish or a combination of swordfish and yellowfin tuna made an average of 11.8 trips per year. Since 2004 there has been an annual fishery-wide cap of 2,120 sets or until caps on turtle interactions are reached, whichever cap is reached first. In 2006 the fishery reached a cap on loggerhead sea turtles after 3 months.
Fishing grounds	From January through March, effort is concentrated between latitudes 15° N and 35° N and longitudes 150° W and 180° W. From April through June tuna fishing effort expands to the south and spreads further east and west to about longitudes 145° W and 170° E.	Primarily the area to the northeast of the Hawaiian Islands on the high seas in the North Pacific Transition Zone.
Fishing season(s)	Year-round	Can be year-round but effort tends to be highest in the first quarter of the year, and due to an annual cap on turtle interactions and effort, the swordfish fishery can be closed for the year once either of these caps is reached
Mainline material	Nylon monofilament	Nylon monofilament
Mainline length	Average of 54 km	30 to 100 km
Mainline deployment	Mainline shooter (to set mainline slack)	Manual (no shooter, to set mainline taught)
Distance between buoys	800 m	500 m
Distance from buoy to mainline (float line length)	22 m (required to be $\geq 20$ m)	8 m

Average branch line length	13 m	17 m
Branch line material	Nylon monofilament	Nylon monofilament
Wire trace or leader on branch lines	Yes (0.5 m length)	No
Number of hooks between buoys	15 to 40	4 to 6
Average maximum depth of hooks when set	234 m	69 m
Average maximum depth of mainline when set	221 m	52 m
Mainline sink rate	10 m per minute	4 m per minute
Timing of set, soak, and haul	Gear is set in the morning, soaks during the day, and is hauled before dark.	Gear is set in the evening no earlier than 1 hour after local sunset, soaks overnight, and is hauled the following morning no later than local sunrise.
Lightstick use	No (prohibited)	One lightstick every 1 to 5 hooks
Number of hooks per set	1,200 to 3,000	700 to 1,000
Hook setting interval	6-8 seconds per hook	12 seconds per hook
Radio beacons	6 per set	6 per set
Hook type	Japan tuna 3.6 ring hook, 14/0, 15/0, and 16/0 circle hooks with 10 degree offset	18/0 circle hooks with a 10 degree offset (required)
Weight size and location	45-80 g weighted swivels located within 1 m of the hook	0 to 80 g weighted swivels attached 5 to 7 m from hook (if weight is attached it is usually attached at the midpoint of the branch line) (in 2005 all swordfish vessels used weighted swivels on branch lines)
Clip size and type	145 mm 148-1/8" x 8/0	145 mm 148-1/8" x 8/0
Bait type	Mackerel, saury, sardine	Mackerel, saury, sardine
Number of crew	Captain and 3 crew	Captain and 4 to 5 crew
Vessel Monitoring System	Yes	Yes

### A8.3. Catch and Discard Rates of Target and Bycatch Species

Table A8.3 summarizes CPUE of all caught (retained and discarded) fish species for combined Hawaii-based longline tuna and swordfish fisheries. Table A8.4 presents the total catch by weight and value of the Hawaii-based longline swordfish and tuna fisheries for 1987-2004. Table A8.5 presents the catch composition for the Hawaii longline fleet by weight and value for 2001.

Table A8.3. Hawaii pelagic longline tuna and swordfish fisheries CPUE, number of caught fish per 1,000 hooks, 1999-2005 (Clemens, 2006).

Year	CPUE (number caught per 1000 hooks)			
	Tunas	Sharks	Billfish	Other Species <sup>a</sup>
1999	9.21	4.59	3.9	4.8
2000	8.18	3.91	2.88	4.8
2001	8.64	2.1	1.61	4.21
2002	7.48	1.87	0.98	4.27
2003	6.33	2.32	1.77	4.58
2004	6.42	2.34	1.24	5.49
2005	5.32	2.15	1.69	5.06

<sup>a</sup> Mahimahi, moonfish, oilfish, pomfret, and wahoo.

Table A8.4. Total catch by the Hawaii-based longline swordfish and tuna fisheries by weight and value, 1987 – 2004 (Western Pacific Regional Fishery Management Council, 2005a).

<b>Year</b>	<b>Catch (x 1,000 lb)</b>	<b>Ex-Vessel Revenue (x \$1,000)</b>
1987	3,890	10,600
1988	6,710	16,500
1989	9,920	23,200
1990	14,730	35,300
1991	19,480	42,900
1992	21,110	44,400
1993	25,010	53,400
1994	18,140	41,800
1995	22,720	43,600
1996	21,550	42,700
1997	27,150	50,100
1998	28,630	46,600
1999	28,350	47,400
2000	23,810	50,200
2001	15,550	33,000
2002	17,480	37,500
2003	17,440	38,600
2004	18,410	39,000
<b>Average</b>	<b>18,890</b>	<b>38,710</b>

Table A8.5. Catch composition of the Hawaii-based longline swordfish and tuna fisheries, by weight and value, 2001 (Western Pacific Regional Fishery Management Council, 2003).

<b>Species</b>	<b>Catch (x 1,000 lb)</b>	<b>Revenue (x \$1,000)</b>
<b>Non-tuna spp.</b>		
Blue marlin	879	730
Striped marlin	775	845
Swordfish (round weight)	485	1,193
Other billfishes	299	242
Mahimahi	530	662
Ono (wahoo)	388	563
Opah (moonfish)	756	930
Sharks (round weight)	327	119
Other	395	529
<b>Subtotal non-tuna spp.</b>	<b>4,834</b>	<b>5,813</b>
<b>Tuna spp.</b>		
Albacore	2,802	3,222
Bigeye	5,217	18,208
Bluefin	2	10
Skipjack	466	238
Yellowfin	2,233	5,516
<b>Subtotal tuna spp.</b>	<b>10,720</b>	<b>27,194</b>
<b>TOTAL</b>	<b>15,554</b>	<b>33,007</b>

The annual average catch of blue, mako, thresher, and other sharks in Hawaii longline fisheries from 1987-2004 was 1,579,700 lb, 137,700 lb, 114,400 lb, and 101,400 lb, respectively, with a combined annual average weight of 1,933,200 lb (Western Pacific Regional Fishery Management Council, 2005a). In 2001, pelagic sharks comprised about 50% of the catch composition of swordfish longline sets, compared to 16% for tuna sets (Ito and Machado, 2001). Shark CPUE has been about 10 times higher in shallow sets targeting swordfish compared to sets targeting tuna (Ito and Machado, 1999). Since

regulations designed to reduce interactions with sea turtles in the Hawaii-based pelagic longline swordfish fishery came into effect in May 2004, which required the fleet to switch from using a 9/0 J hook with squid bait to a wider 18/0 10 degree offset circle hook with fish bait, there has been a significant 36% decrease in shark (combined species) CPUE relative to the period before the sea turtle regulations came into effect (Gilman et al., 2006a). From 1994 – 2002, the period before the sea turtle regulations came into effect, shark CPUE for the Hawaii-based longline swordfish fishery was 21.9 sharks per 1000 hooks (20.4 – 23.5 95% CI). From 2004 – 2006, the period since the sea turtle regulations have been in effect, shark CPUE was 14.0 sharks per 1000 hooks (13.6 – 14.5 95% CI). Based on research conducted in the Azores longline swordfish and blue shark fishery (Bolten and Bjorndal 2002) and U.S. North Atlantic longline swordfish fishery (Watson et al., 2005), this observed decrease in shark CPUE is likely due to the fleet's change from using squid to mackerel for bait.

From 1994 – 2006, observer data show that blue sharks comprised 92.6% of total caught sharks in Hawaii longline swordfish targeting sets. From 1994 – 2006, observer data show that blue sharks comprised 82.2% of total caught sharks in Hawaii longline tuna targeting sets. From 1993 – 2000, logbook data show that blue sharks comprised an average of 87.5% of total reported shark catch, with an average of 3,509 lbs of blue sharks caught annually (Western Pacific Regional Fishery Management Council, 2005a). From 2001 – 2004, blue sharks comprised an average of 18.4% of total reported shark catch, with an average of 65,500 lbs of blue shark caught annually (Western Pacific Regional Fishery Management Council, 2005a). The Hawaii-based longline swordfish fishery was closed from February 2002- May 2004 due to concerns over interactions with sea turtles (Gilman et al., 2006a,b), which explains the substantial drop in weight and proportion of blue shark catch during this period.

Table A8.6 presents statistics from logbook data on shark bycatch in combined Hawaii-based longline tuna and swordfish fisheries from 1994-1999 and for 2004. Table A8.7 presents statistics for only observed sets targeting swordfish by Hawaii-based longline vessels on the condition of sharks when hauled to the vessel, condition of discarded sharks, and number and proportion of retained sharks. Table A8.8 presents similar statistics from observer data for observed sets targeting tuna. An increase in demand for shark fins, resulting from increasing income in China, and increased demand from the U.S. mainland for Hawaii shark fins as the supply from U.S. Atlantic coastal shark fisheries declined due to significant reductions in shark quotas, are believed to explain the gradual increase in percent of caught sharks that were finned from 1994-1999 (McCoy and Ishihara, 1999; U.S. National Marine Fisheries Service, 2001). In 1999, before restrictions on shark finning were instituted, 65.4% of caught sharks were finned while carcasses of only 1.1% of caught sharks were retained for combined Hawaii longline fisheries (U.S. National Marine Fisheries Service, 2001). The Shark Finning Prohibition Act came into effect in March 2002, which explains the sudden drop in retention of only fins from caught sharks. Whole shark carcasses have been a stable and insignificant component of shark landings, typically representing < 1% of shark catch. Hawaii longliners generally only retain carcasses of mako and thresher sharks as the meat from these species are the only ones that are marketable, although occasionally a vessel will retain carcasses of blue and other shark species. For example, in 2004, 44.7% (830) and 13.7% (717) of the total number of caught mako and thresher sharks were retained, respectively, while only 2.0% (1,303) and 6.9% (210) of the total number of caught blue and 'other' sharks were retained, respectively, in 2004 (Western Pacific Regional Fishery Management Council, 2005a). In 2004 the average price per pound (whole weight) for shark meat was \$0.17, down from \$0.32 in 2003 (Western Pacific Regional Fishery Management Council, 2005a).

Table A8.7 includes statistics from observer data on the proportion of caught sharks that are alive vs. dead when hauled to the vessel and the condition of discarded sharks in Hawaii-based longline swordfish sets for the period that these data have been collected from 2004-2006, during which time there has been 100% observer coverage. Table A8.9 provides the same statistics for the Hawaii-based longline tuna fishery, with information on the condition of sharks when hauled to the vessel starting in 2003. Over 89% of sharks caught in swordfish gear and over 93% of sharks caught in tuna gear are alive when the gear is retrieved. In swordfish gear, < 0.82% of sharks that are hauled to the vessel alive are discarded dead, while in tuna gear < 4.3% of sharks hauled alive are discarded dead. Hawaii-based longline crew have not been killing a large proportion of sharks caught alive before discarding them. However, information

on the types of injuries of discarded sharks is not available, which might provide an indication of their post release survival prospects.

Table A8.6 Number caught and disposition of sharks in Hawaii pelagic longline fisheries from logbook data, 1994-1999, 2004 (Ito and Machado, 1999; U.S. National Marine Fisheries Service, 2001; Western Pacific Regional Fishery Management Council, 2005a).

<b>Year</b>	<b>Number sharks caught</b>	<b>Number sharks discarded</b>	<b>Number sharks only fins retained</b>	<b>Number whole sharks retained</b>	<b>Percent sharks retained (any part of individual shark is retained)</b>	<b>Percent sharks finned</b>
1994	114,656	98,119	15,374	1,163	14.4	13.4
1995	101,292	67,760	32,842	690	33.1	32.4
1996	100,992	57,254	43,109	629	43.3	42.7
1997	85,838	36,496	48,552	790	57.5	56.6
1998	99,919	39,062	60,083	774	60.9	60.1
1999	87,576	29,308	57,286	982	66.5	65.4
2004	74,917	71,857	0	3,060	4.1	0

Table A8.7. Shark capture statistics from onboard observers for the Hawaii-based longline swordfish fishery, 1994-2006 (National Marine Fisheries Service Observer Program unpublished data).

Year a	No. Caught Sharks	CPUE (No. Sharks Per 1000 Hooks)	Condition When Hauled to Vessel b			Retained Fins Only		Retained Carcass Plus Other Parts		Discarded Alive		Discarded Dead		Discarded Unknown Condition		No. Hauled Alive and Discard Dead	% Hauled Alive and Discard Dead
			No. Alive	% Alive	No. Dead	No.	%	No.	%	No.	%	No.	%	No.	%		
1994	3738	19.9		Not Known		206	5.5	29	0.8	2472	66.1	410	11.0	621	16.6		Not Known
1995	3601	28.7		Not Known		854	23.7	15	0.4	821	22.8	1283	35.6	628	17.4		Not Known
1996	4100	19.9		Not Known		1675	40.9	18	0.4	1979	48.3	80	2.0	348	8.5		Not Known
1997	6338	31.6		Not Known		4067	64.2	7	0.1	1613	25.4	295	4.7	356	5.6		Not Known
1998	3501	24.6		Not Known		1558	44.5	14	0.4	1597	45.6	118	3.4	214	6.1		Not Known
1999	1946	14.7		Not Known		975	50.1	23	1.2	699	35.9	49	2.5	200	10.3		Not Known
2000	3098	13.1		Not Known		710	22.9	13	0.4	1785	57.6	336	10.8	254	8.2		Not Known
2001	482	11.8		Not Known		14	2.9	0	0.0	446	92.5	15	3.1	7	1.5		Not Known
2002	300	24.8		Not Known		28	9.3	0	0.0	262	87.3	10	3.3	0	0.0		Not Known
2004	1771	14.8	1586	89.6	185	0	0.0	8	0.5	1570	88.7	182	10.3	11	0.6	9	0.57
2005	17282	12.8	16112	93.2	1170	1	0.0	163	0.9	15907	92.0	1210	7.0	1	0.0	122	0.76
2006	11299	16.7	10675	94.5	624	0	0.0	63	0.56	10548	93.35	688	6.09	0	0.0	88	0.82

<sup>a</sup> There were no swordfish sets in 2003.

<sup>b</sup> Data on condition of sharks when hauled to the vessel began to be collected by onboard observers in 2004 for the swordfish fishery.

Table A8.8. Shark capture statistics from onboard observers for the Hawaii-based longline tuna fishery, 1994-2006 (National Marine Fisheries Service Observer Program unpublished data).

Year	No. Caught Sharks	No. Observed Hooks <sup>a</sup>	CPUE (No. Sharks Per 1000 Hooks)	Condition When Hauled to Vessel			Retained Fins Only		Retained Carcass Plus Other Parts		Discarded Alive		Discarded Dead		Discarded Unknown Condition		No. Sharks Hauled Alive and Discard Dead	% of Sharks Hauled Alive and Discard Dead
				No. Alive	% Alive	No. Dead	No.	%	No.	%	No.	%	No.	%	No.	%		
1994	2338	337548	6.9	Not Known			756	32.3	53	2.3	1214	51.9	119	5.1	196	8.4	Not Known	
1995	3103	492110	6.3	Not Known			1381	44.5	76	2.4	1275	41.1	143	4.6	228	7.3	Not Known	
1996	3596	543209	6.6	Not Known			2222	61.8	59	1.6	576	16.0	98	2.7	641	17.8	Not Known	
1997	1700	376528	4.5	Not Known			1379	81.1	23	1.4	245	14.4	34	2.0	19	1.1	Not Known	
1998	3950	625667	6.3	Not Known			2813	71.2	39	1.0	808	20.5	226	5.7	64	1.6	Not Known	
1999	1908	553319	3.4	Not Known			1446	75.8	57	3.0	313	16.4	36	1.9	56	2.9	Not Known	
2000	17714	2096419	8.4	Not Known			141	0.8	733	4.1	14597	82.4	2034	11.5	209	1.2	Not Known	
2001	17302	5072839	3.4	Not Known			473	2.7	484	2.8	14338	82.9	1691	9.8	316	1.8	Not Known	
2002	11100	6683510	1.7	Not Known			2751	24.8	278	2.5	6200	55.9	1340	12.1	531	4.8	Not Known	
2003	21649	6551314	3.3	12940	95.9	554	8	0.0	416	1.9	19310	89.2	1729	8.0	166	0.8	552	4.3
2004	26273	7937327	3.3	24751	94.2	1521	6	0.0	452	1.7	24071	91.6	1631	6.2	113	0.4	342	2.6
2005	23980	9324984	2.6	22928	95.6	1052	2	0.0	434	1.8	22438	93.6	1100	4.6	6	0.0	176	0.8
2006 <sup>b</sup>	14735	6732291	2.2	13767	93.4	968	2	0.0	305	2.1	13454	91.3	971	6.6	2	0.0	94	0.7

<sup>a</sup> From 1994-1998 a substantial proportion (19.6%) of the observed hooks in sets targeting tuna were set shallow primarily to target yellowfin tuna, where there were fewer than 8 hooks in a basket, vs. sets targeting bigeye tuna, where gear is set deeper and baskets usually contain about 15 hooks. This dropped to 2.6% of hooks in baskets of < 8 hooks for the period 1999-2001, and 0% after 2001. This may explain the relatively high shark CPUE for the period 1994-1998.

<sup>b</sup> 2006 data are through 1 December.



#### A8.4. Management Framework Relevant to Shark Interactions

In 2000 the U.S. Congress and State of Hawaii passed legislation restricting shark finning practices. Federal regulations implementing the Shark Finning Prohibition Act came into effect on 13 March 2002 (U.S. National Marine Fisheries Service, 2002). The federal Act amended the Magnuson-Stevens Fishery Conservation and Management Act to prohibit (i) any person aboard a U.S. fishing vessel from 'finning sharks', defined as taking a shark, removing fins, and returning the remainder of the shark to the sea; (ii) any person from possessing shark fins aboard a U.S. fishing vessel without the corresponding carcasses; (iii) any person from a U.S. fishing vessel from landing shark fins without the corresponding carcasses; (iv) any person on a foreign fishing vessel from engaging in shark finning in the U.S. EEZ, from landing shark fins without the corresponding carcasses into a U.S. port, and from transshipping shark fins in the U.S. EEZ; and (v) the sale or purchase of shark fins taken in violation of these prohibitions (U.S. National Marine Fisheries Service, 2002). The Act states that any shark fins landed from a fishing vessel or found onboard a fishing vessel were taken, held or landed in violation of the Act if the total weight of shark fins exceeds 5% of the total dressed weight of shark carcasses landed or found on board (U.S. National Marine Fisheries Service, 2002, 2005b). The aims of the Act are to (i) prevent unsustainable levels of shark catch, which is now a risk due to the demand for shark fins, and (ii) prevent the waste of usable shark meat (U.S. National Marine Fisheries Service, 2002). To achieve these aims, there is an unstated assumption that the ban on finning will reduce shark fishing mortality.

From 1999 through 2004 the Hawaii longline fleet, especially the swordfish component, was subject to area and temporal closures that were intended to protect sea turtles. In April 2004, the swordfish component of the Hawaii longline fishery was authorized to resume after being closed for over two years, but is subject to measures limiting effort, requiring the use of specific types of hook and bait, capping annual turtle interactions, requiring 100% observer coverage, and other measures. Measures designed to reduce the capture of seabirds by Hawaii longline vessels were first required in 2001. These seabird and sea turtle avoidance measures affect the fishing methods, gear, and effort of the fleet, and may affect shark interactions. As part of rules that are intended to reduce sea turtle interactions, Hawaii longline vessels that are deep-setting to target tuna are prohibited from using light sticks, must use float lines that are  $\geq 20$  m in length, and have an annual cap on effort of 2,120 sets targeting swordfish (Western Pacific Regional Fishery Management Council, 2005b). Also, as part of rules designed to reduce turtle interactions, Hawaii longline vessels that are shallow-setting to target swordfish must use 18/0 or larger circle hooks with a  $10^\circ$  offset and can use only 'mackerel-type bait' when fishing North of the equator (Western Pacific Regional Fishery Management Council, 2005b). As part of rules intended to reduce seabird interactions that might affect shark interactions, shallow-setting swordfish vessels that are stern-setting must (i) set only at night, (ii) dye fish bait blue, and (iii) discharge fish, offal, or spent bait from the opposite side of the vessel from where longline gear is being set or hauled, or otherwise they can set their gear from the side of the vessel and attach weights  $\geq 45$  g within 1 m of the hook (Western Pacific Regional Fishery Management Council, 2005b). To comply with seabird regulations that might affect shark interactions, deep-setting vessels targeting tuna that are stern setting must, when fishing North of 23 degrees N. latitude, (i) use blue-dyed bait; (ii) discard offal, spent bait, and fish during setting and hauling; and (iii) attach weights  $\geq 45$  g within 1 m of the hook, or otherwise side set with a minimum of 45 g weights attached on branch lines within 1 m of the hook (Western Pacific Regional Fishery Management Council, 2005b).

All Hawaii-based longline vessels are required to have a VMS unit onboard, which is a satellite transponder that provides 'real-time' position updates and the track of the vessel movements. There is 100% onboard observer coverage of shallow-setting swordfish longline vessels, and about 20% observer coverage of the tuna longline fleet (Western Pacific Regional Fishery Management Council, 2005b). The Hawaii longline fishery is limited entry, vessels cannot exceed 30.8 m in length, and as part of rules adopted to manage turtle mortality, there is a cap on the annual swordfish effort of 2,120 sets targeting swordfish (Western Pacific Regional Fishery Management Council, 2005b). In early 1991 longline fishing was prohibited within 50 nm of the Northwestern Hawaiian Islands to prevent interactions between endangered populations of Hawaiian monk seals. An additional longline exclusion zone was established in mid 1991 50-75 nm around the Main Hawaiian Islands to prevent gear conflicts between longliners and

smaller fishing boats targeting pelagic species (Western Pacific Regional Fishery Management Council, 2005b).

### **A8.5. Economic, Social, and Ecological Effects, Including Effects on Fishing Practices, from Regulations Governing Shark Interactions**

Of the twelve fishermen interviewed, nine were longlining based from Hawaii, one was longlining based from California, and two were not longlining in the U.S. prior to when the rules on shark finning came into effect. Eight of the ten fishermen who were fishing in the U.S. before the shark finning regulations came into effect used to fin sharks, while two stated that they did not fin sharks when it was legal. The eight fishers that used to fin sharks had received a total of between \$400 - \$3000 per trip from the sale of shark fins (mean of \$1,620 per trip, or about \$8,100 per crew per year, assuming three crew per vessel and 15 trips per year). Crew received the revenue from the sale of fins.

This is generally consistent with findings of McCoy and Ishihara (1999) who report that, prior to the adoption of regulations on shark finning, income from shark fins was retained by the crew except for some vessels where owners, mostly on owner-operated vessels, retained a share of the revenue from shark fins. Hamilton (1996) reports that average annual wages for Hawaii longline crew was \$22,000 based on data from 1993-1995. McCoy and Ishihara (1999) estimate that in 1998 (prior to the adoption of regulations on shark finning) crew earned an average annual income from shark fin sales of between \$2,375 to \$2,850, 10-11% of their estimated annual wage. On some bad trips, a crew's revenue from shark fins could exceed their share from the sale of the catch. In 1998 an estimated 38 t of dried shark fins with an ex-vessel value of about \$1 million was produced, of which about 95% came from blue sharks (McCoy and Ishihara, 1999). In 1998, logbook records show that of 97,080 sharks caught by the Hawaii longline fleet, 58,444 sharks were finned (53,822 blue sharks, 579 mako, 1,357 thresher, and 2,686 other) (McCoy and Ishihara, 1999).

Most (66%) of the interviewed fishermen report occasionally retaining one mako shark every two or three trips, if it is caught in the last 2-3 sets of the trip and space remains in the hold, and that they less frequently retain a thresher shark. Two of the twelve fishermen report that they now discard the fins of retained sharks because the vessel owner or captain does not want to risk violating the shark regulations or raise negative public perceptions. For vessels that do retain fins, crew still receive the revenue from the sale of the fins, but this amounts only to about \$50 from the sale of one set of mako or thresher fins every one to two trips. Revenue from shark meat is divided by the vessel the same as any other landed fish. One captain reports that his crew occasionally cleans and sells a mako jaw for about \$25 a jaw. Since the restrictions on finning came into effect, the revenue from catching sharks is exceeded by the cost from shark depredation and loss and damage to gear.

Only one fisherman reports changing his fishing methods as a result of the adoption of shark finning restrictions; the captain of this longline tuna vessel (F/V Garden Sun) now sets his main line shooter at a faster speed to make the main line relatively more slack to increase its setting depth, to target higher quality tuna, but also to reduce the shark capture rate. All others report not having made any changes to their fishing methods and gear as a result of the shark finning rule.

### **A8.6. Practices to Deal with Caught Sharks and Costs from Shark Depredation and Gear Damage**

Almost all Hawaii longline tuna vessels use ca. 45 cm-long wire traces at the end of branch lines, located between the baited hook and a weighted swivel, while swordfish vessels do not use a wire trace. As a result, sharks that bite baited hooks in tuna gear tend to be retained on the line, while about a quarter of sharks that bite baited hooks in swordfish gear bite through the monofilament line and are not retained on the line to be hauled to the vessel. Longline tuna vessels catch an average of 9.5 sharks on a typical set. Longline swordfish vessels catch an average of 25 sharks on a typical set.

The potential exists to increase post release survival prospects and reduce fishing mortality of caught and discarded sharks through improved handling and release practices by crew. For about 66% of caught sharks, crew cut branch lines after bringing the shark as close to the vessel hull as possible. For about 34% of caught sharks, when crew are not too busy processing commercially valuable caught fish, they will bring smaller sharks of species that are relatively easier to handle or that are dead when hauled to the vessel and are small enough to lift up onto the rail on the bulwark and remove the hook with a small filet knife (Fig. A8.2). Crew report being able to occasionally yank the hook out of a caught shark that is loosely-hooked. When the crew cut the branch line to discard a shark, they will usually lose the terminal tackle, including the hook, wire leader, swivel, and a bit of monofilament line for tuna gear, and the hook, monofilament line, and sometimes a lightstick and swivel for swordfish gear. Some crew on tuna vessels report that they occasionally are able to bring the caught shark close enough to the vessel hull to cut the wire leader to discard a shark, thus retaining the swivel and part of the wire. If there are fish on deck that need to be processed and preserved, crew may decide not to spend time and effort handling sharks to retrieve terminal tackle and cut branch lines containing sharks or dropping the entire branch line containing the caught shark. Two fishers report that, when they are busy processing commercially valuable species, they will place a tarred rope with a knot at the end off the stern and will clip branch lines containing sharks onto this rope so they can remove the sharks from the gear after they have completed the haul and processed the catch. At the end of the haul, about 75% of the sharks that are put on the 'shark line' have fallen off the hooks, some of the lines break (and the weighted swivels hit the stern of the vessel – this vessel has a high bulwark so these flying weights do not pose a risk to the crew), while the sharks remaining on the line at the end of the haul are usually dead. One captain reports killing all caught sharks in an effort to minimize future shark depredation, which is a practice also reported by McCoy and Ishihara (1999), however observer data show that a very small proportion of caught sharks that are alive when hauled to the vessel are killed before discarding (Tables A8.7 and A8.8). Several respondents reported catching the same shark as many as ten times in a single haul. McCoy and Ishihara (1999) report that before restrictions on finning were instituted, some Hawaii longline fishers had used a 220-volt electrical line rigged to a gaff to stun sharks before landing. None of the interviewed fishers report using a dehooker device to try to remove a hook from a caught shark because they believe this would be more dangerous or time consuming than their current practice, and that it would require more than one crew to use. Some sharks will twist and spin when hauled to the vessel, or the shark might close their mouth on the dehooker, which could result in the dehooker being dropped overboard. One respondent said that it would be too difficult to use a dehooker because it would not be possible to get enough slack in the line to push the hook out when using the dehooker. The more sharks that they catch, the longer it takes them to haul the gear as they have to take time to remove caught sharks from the gear to discard them. Because sharks are on the sea surface during hauling, crew are concerned about having branch lines break if a shark pulls the line, and use of a dehooker might increase the incidence of this occurring if using a dehooker required bringing the shark close to the vessel. The crew will rebuild all branch lines on which sharks were caught as the sharks tend to stretch the line and chafe the line from contact with their skin, weakening it so that there is a risk of losing a caught fish on a subsequent set if the gear were not rebuilt. Fishers also report that occasionally a caught shark will break the main line, and that it has taken them as long as two days to locate both main line segments, and occasionally a caught shark, usually threshers, will pull the gear down so that branch lines become entangled, requiring a substantial amount of time to correct as well as reduced catch of commercially valuable species. The average cost from damage and loss of gear to sharks is \$19 and \$50 on typical tuna and swordfish sets, respectively.



Fig. A8.2. Hawaii longline crew demonstrating how they clip a loop of rope onto a branch line below the weighted swivel at the top of the wire leader to assist with removing a hook from a caught shark.

Fishers report having an average of 3 commercially valuable fish species damaged from shark bites on a typical longline tuna set and 5 commercially valuable fish species damaged on a typical swordfish set. This can represent a loss of several thousands of dollars depending on the size and species of fish that are damaged. On an especially bad set, as many as 50% of target species may be damaged to a degree that they cannot be sold. An average sized bigeye tuna weighs about 79 lb, and typical price per lb is USD 3.50. An average sized swordfish weighs 150 lb and typical price per lb is USD 4.50. Assuming that average sized bigeye tunas are damaged by sharks in the tuna fishery and average sized swordfish are damaged in the swordfish fishery, and assuming tuna vessels make 15 trips per year and swordfish vessels make 12 trips per year, very roughly, annual costs for a vessel from shark depredation due to damage to fish in the tuna and swordfish fisheries is USD 393,750 and 688,500, respectively.

Over half (58%) of respondents reported that shark interactions are a problem more because of the amount of time they have to spend to remove the sharks from the gear and to repair and replace gear versus from the actual cost of lost and damaged gear and damaged fish. A quarter of the respondents feel that the problems from shark interactions of time they have to spend to repair and replace damaged gear and to remove sharks from the gear and the actual cost from lost and damaged gear and damaged fish are about equal in scale. One respondent, who is a captain of a tuna longline vessel who reported having the lowest shark capture rate of interviewed fishers, who stated that he sets his gear relatively deeper than other tuna vessels, and does not use wire trace on his branch lines, responded that neither the time or cost resulting from shark interactions are problematic.

Most (75%) of interviewed fishers would rather avoid catching sharks if they could even if there were no rules restricting their use of sharks, including restrictions on finning. Most cited reasons for this response were that (i) they want to avoid the safety risk when a shark is hauled to the vessel and the line breaks and swivels hit the crew, (ii) the economic costs from shark interactions would still exceed revenue from shark fins and other parts, and (iii) they would rather avoid spending the time to deal with caught sharks and the damage they cause to their gear than receive the revenue from shark fins and meat. Two thirds of respondents reported that, if regulations allowed, their revenue from catching sharks would still not become an economic advantage. The other third of respondents believe that their revenue from shark fins would exceed economic costs from shark interactions if the restrictions on finning were removed.

### **A8.7. Onboard Processing of Retained Sharks**

Sharks that will be retained and landed are finned, the head is removed from the third gill, gutted, and put on ice with the rest of the retained fish. If fins are to be retained, some fishers report freezing them, while others will dry them near the engine.

### **A8.8. Reasons for Discarding Sharks**

In addition to rules restricting the retention of shark fins, fishers will discard sharks for a combination of additional economic, safety, and social reasons. Shark meat and fins are marketable for only two species (mako and thresher), and are relatively very low value compared to target and other incidental catch species. Thus, the relatively low product value of sharks means fishers will save their storage capacity for more valuable species. All respondents cited that the risk of crew being injured from landing sharks (from being bitten and from being hit by swivels if the branch line breaks during hauling) as another central reason for deciding to discard sharks of marketable species. Two respondents indicated that they never finned sharks, even before restrictions were instituted, one because of concerns about the relatively high risk of overfishing shark species, and the other because of a combination of not wanting to spend the time to process the sharks and concern of crew safety. Two thirds of respondents report that they now occasionally will retain a shark, but only a quarter of respondents will retain the fins of the sharks that they decide to retain. One quarter (3 of 12) of respondents now never retain sharks. Fishers of vessels that do sometimes retain sharks will only consider retaining meat and fins of mako and thresher sharks, and occasionally a jaw, and generally only will retain a shark if it is near the end of a trip (the last 2-3 days) and space in the hold is available. Thus, fishers generally always discard non-marketable shark species and discard marketable species if it is early in a fishing trip, so as to not waste hold space on these low value species and to avoid possible contamination of the rest of the catch. This was the case even before regulations on shark finning were promulgated (McCoy and Ishihara, 1999). Sharks that are to be used for their meat that are preserved on ice must be landed within a few days of capture to ensure adequate quality and to avoid tainting the rest of the catch (McCoy and Ishihara, 1999). Contamination of the catch and ice with urea occurs from contact with shark blood.

### **A8.9. Practices Employed to Reduce Shark Capture and Depredation**

Respondents identified employing a few strategies to reduce shark capture and depredation. The most common identified practice to avoid shark interactions is changing the fishing position if the shark catch rate is especially high but the target species catch rate is not high. Some respondents reported that if the shark catch rate is especially high, even if the target species catch rate is high, they will still move their location before making another set because they want to avoid the large amount of time it takes to haul the gear when a large number of sharks are caught. Two respondents report that if they are hauling and are catching a large number of sharks, they will stop the haul for about one hour in an attempt to reduce the shark catch rate. Several respondents report avoiding fishing in certain areas known to have high shark abundance or when other vessels communicate a position that has especially high shark catch rate. One respondent reports setting his tuna gear deeper, in part, to reduce shark capture rates.

### **A8.10. Reasons for Discontinuing Any Methods Attempted to Reduce Shark Interactions**

One fisher tried various types of artificial baits to determine their ability to catch target species and to reduce shark capture. He found that the artificial baits did not catch tuna well and that they were not strong enough as he lost about 90% of the artificial baits after one fishing trip. None of the other respondents reported having tried a strategy to reduce shark interactions that they determined was not effective or practical. One fisher is planning to try an artificial bait that he recently ordered from a Korean manufacturer.

## A8.11. Perceptions on Efficacy and Commercial Viability of Strategies to Reduce Shark Interactions

### A8.11.1. Avoiding peak areas and times of shark abundance

Two thirds of respondents believe that it is possible to avoid peak areas and times of shark abundance. Most respondents believe that shark catch rates will be highest around certain topographic features such as seamounts and certain oceanographic features, but some respondents explained that this is where target species catch rates will also be highest, making it not economically efficient to avoid these areas. A longline swordfish captain believes that shark abundance will be higher on the colder side of fronts (where temperature is about 61 F) while swordfish will be more abundant on the warmer side of the front (where the temperature is about 64-65 F), while three longline tuna captains believe the opposite is true, that certain species of sharks will be more abundant on the warm side of fronts. Two tuna longline captains described specific areas and times when shark CPUE is predictably high (in the winter at 14.5 N. latitude between 160-166 W. longitude, and between 20-22 N. latitude, 162-165 W. longitude) where they avoid fishing. Ito and Machado (1999) show that, in 1998, shark CPUE was highest in the Hawaii longline swordfish fishery in one area north of the Hawaiian Islands (Fig. A8.3).

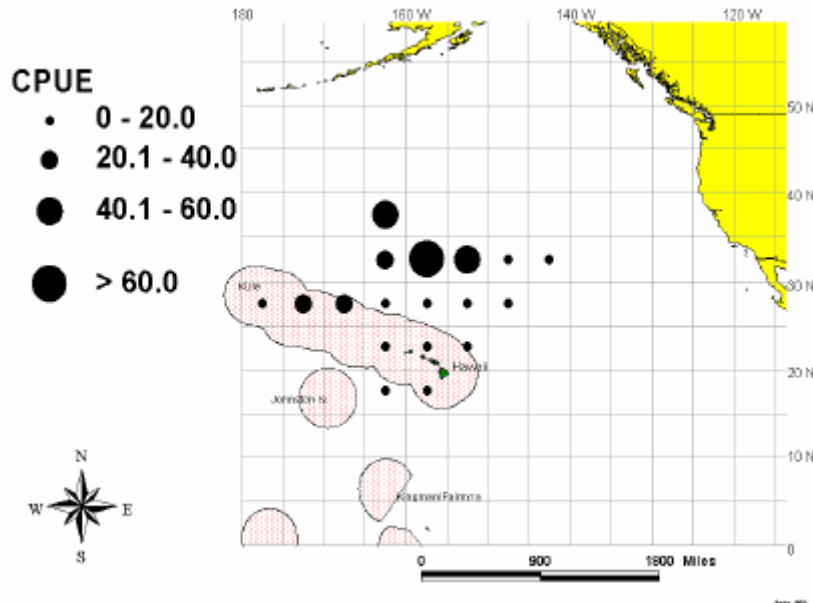

Fig. A8.3. Blue shark CPUE (fish per 1000 hooks) by area for Hawaii-based longline vessels setting gear shallow to target swordfish and yellowfin tuna, 1998 (Ito and Machado, 1999).

### A8.11.2. Reducing the detection of baited hooks by sharks, such as by refraining from chumming during the set and not discarding offal and spent bait during the haul

Three quarters of respondents do not believe that refraining from chumming during the set and refraining from discarding offal and spent bait during the haul will reduce shark depredation and bycatch. One quarter of the respondents believe it may help reduce interactions with certain shark species that follow the vessel during hauling. Only one respondent reports chumming, during the end of sets. All vessels discard spent bait and offal during the haul, and all respondents believe it would be impractical to retain the spent bait on the haul. One respondent explained that he catches roughly the same number of sharks per unit effort even when all of the baits have fallen off or been removed from the gear (such as from depredation by squid) and they are not discarding offal versus when bait remains on hooks and he is discarding offal.

**A8.11.3. Limiting shark access to baited hooks, such as altering fishing practices to consider deployment depth of hooks and timing of the soak and haul to avoid problematic shark species**

Half of the respondents believe that it is possible to reduce shark interactions by setting baited hooks deeper. Two of the longline tuna captains explained that while they believe it is possible to reduce shark catch by setting gear deeper, they would not do this because it would reduce their catch rate of target species, and because their catch of sharks is not typically problematic. None of the respondents believe that altering the timing of fishing operations would affect their shark catch rate.

**A8.11.4. Deterring sharks such as with chemical shark deterrents and electrical deterrents**

A third of respondents believe that deterrents such as chemical compounds and electrical currents will not be effective at reducing shark bycatch and depredation, while two thirds replied that they do not know if they would be effective. One respondent believes that these types of deterrents won't work if sharks are in a feeding frenzy. Several respondents explained that they would want to know research results on the effect of these strategies on target species CPUE. Two respondents explained that the cost of the deterrent would have to be sufficiently low for them to use it because shark catch and depredation is typically not a large economic problem.

**A8.11.5. Reducing the attractiveness of baited hooks to sharks, such as by using artificial baits, using or not using light sticks, or avoiding a bait type known to result in high shark catch rates**

A quarter of respondents believe that artificial bait holds promise to reduce shark interactions, but research is needed to find a product that is effective at catching target species. Over half of the respondents replied that they do not know if these strategies would be effective, but that they would have to be economically viable and not reduce target species CPUE. A minority of respondents (2, 17%) believe that these strategies would not be effective. A longline swordfish captain explained that he catches sharks at equal rates on hook with and without lightsticks, so he does not believe that refraining from using lightsticks will affect shark catch rates or depredation.

**A8.11.6. Reducing injury to hooked sharks that you will discard**

Most respondents believe that sharks that are discarded by cutting the branch line or cutting their mouth to remove the hook are not injured to a degree that it will result in their eventual mortality. Several fishers replied that they would not want to bring sharks closer to the vessel than their current practice because this would increase the risk of the swivels hitting the crew if the line breaks; About two thirds of caught sharks are discarded by cutting the branch line. Two fishers that report using a 'shark line' to temporarily hold branch lines containing caught sharks when they are too busy processing fish on deck to remove the gear from the sharks replied that discontinuing this practice would reduce the mortality of caught sharks. All respondents replied that dehookers would increase the risk of injury to crew, are not effective due to the way many sharks roll when being handled, and could result in increased injury to the shark if they bite on the dehooker while spinning.

**A8.11.7. Reducing shark retention by avoiding a specific size or type of hook, or by not using wire leaders on branch lines**

Two thirds of respondents do not believe that the design or size of the hook would affect the shark catch rate. Most respondents replied that shark retention would be reduced by not using a wire leader on their branch lines. The two interviewed captains (one longline tuna and one longline swordfish captain) who do not use wire leaders on their branch lines replied that they would not want to switch to using a wire leader because they believe it would decrease their target species CPUE. The ten fishers (from longline tuna vessels) who use wire leaders replied that they would not want to eliminate use of the wire leader because this would reduce their tuna CPUE and would increase the risk of injury to crew from being hit by swivels if lines break during hauling.

**A8.11.8. Will the economic impact of sharks be reduced from using a wire leader on branch lines**

None of the respondents would be willing to change their current gear design to add or remove a wire leader in order to change the retention of caught sharks on the gear because they believe that this change would result in a net economic cost by reducing target species CPUE. Most respondents replied

that the cost from damage to gear would only be slightly reduced by using vs. not using a wire leader on branch lines, as more terminal tackle could potentially be saved when sharks are caught on branch lines with wire leaders.

**A8.11.9. What is the most important factor that affects shark CPUE - altering fishing position in relation to certain water temperature, topographic features, or oceanographic features; changing the time of day or month of setting or hauling; changing the depth of hooks, or a combination of these factors?**

Most respondents believe that the shallower their gear, the closer the fishing gear is to topographic features such as seamounts and shelf breaks, and proximity to oceanographic fronts are the three most important variables that will result in a high shark catch rate. A longline swordfish captain believes that shark abundance will be higher on the colder side of fronts while three longline tuna captains believe that certain species of sharks will be more abundant on the warm side of fronts. Time of day, month, and year were not considered to be important factors determining shark capture.

**A8.12. Incentives and Attitudes on Reducing Shark Bycatch and Depredation**

In general, both captains and crew in the Hawaii pelagic longline swordfish and tuna fisheries are interested in reducing shark bycatch and depredation as long as the method employed to achieve this does not also reduce their catch rate of commercially valuable species. The four most common reasons identified for wanting to reduce shark interactions are to (i) reduce the time required to discard caught sharks, (ii) reduce the time and expense of replacing and repairing lost and damaged gear, (iii) reduce lost revenue from damaged target and incidental catch, and (iv) reduce the risk of injuring crew from being hit by weighted swivels when branch line break during hauling. Most (two thirds) of respondents stated that they wish to reduce catch rates of sharks in order to reduce the loss of revenue, where the capture of every shark is one less hook available to catch a target species. A few respondents clarified that that they want to avoid catching sharks because most shark species have no economic value and the two species that can be sold are worth relatively very little.

Only one respondent believes, in the absence of restrictions on finning sharks, that fishing mortality would result in the decline of shark populations or that overfishing would occur.

Most (75%) of the respondents stated that their general feelings about sharks are that they are a 'nuisance' and that they wish they could avoid them. Many respondents see shark depredation, requiring time to remove sharks from hooks, damaging and losing gear, and damaging and losing caught fish, as an expected and unavoidable part of longline fishing. A few respondents believe that sharks are more than just a nuisance, as shark interactions reduce the viability of their livelihood. This is generally consistent with the results reported by McCoy and Ishihara (1999). Two fishers indicated that they see sharks as an apex predator at the top of the marine food chain, and as such, sharks play an important role in maintaining the natural functioning of the ocean ecosystem. One respondent sees sharks as a renewable natural resource, which should be managed for optimal yield just like other commercial marine fish, and that fishers should be able to fin them under a sustainable management regime.

**A8.13. References**

- Boggs, C. 1992. Depth, capture time, and hooked longevity of longline-caught pelagic fish: Timing bites of fish with chips. *Fishery Bulletin* 90(4): 642-658.
- Bolten, A., Bjorndal, K., 2002. Experiment to Evaluate Gear Modification on Rates of Sea Turtle Bycatch in the Swordfish Longline Fishery in the Azores. Final Project Report submitted to the U.S. National Marine Fisheries Service. Archie Carr Center for Sea Turtle Research, University of Florida, Gainesville, Florida, USA.
- Brothers, N., E. Gilman. 2006. *Technical Assistance for Hawaii Pelagic Longline Vessels to Change Deck Design and Fishing Practices to Side Set*. Hawaii Longline Association, U.S. NOAA Fisheries



- Pacific Islands Fisheries Science Center and Pacific Islands Regional Office, and Western Pacific Regional Fishery Management Council: Honolulu, Hawaii.
- Clemens, A. 2006. Annual Report on Seabird Interactions and Mitigation Efforts in the Hawaii Longline Fishery for Calendar Year 2005. Administrative Report AR-PIR-04-06. U.S. National Marine Fisheries Service, Pacific Islands Regional Office, Honolulu, HI, USA.
- Gilman, E., D. Kobayashi, T. Swenarton, P. Dalzell, I. Kinan, N. Brothers. 2006a. Efficacy and Commercial Viability of Regulations Designed to Reduce Sea Turtle Interactions in the Hawaii-Based Longline Swordfish Fishery. Western Pacific Regional Fishery Management Council, Honolulu, HI, USA. ISBN 1-934061-02-6.
- Gilman, E., Zollett, E., Beverly, S., Nakano, H., Shiode, D., Davis, K., Dalzell, P., Kinan, I., 2006b. Reducing sea turtle bycatch in pelagic longline gear. *Fish and Fisheries* 7(1): 2-23.
- Hamilton, M., R. Curtis, M. Travis. 1996. *Cost-earnings Study of the Hawaii-based Domestic Longline Fleet*. JIMAR Contribution 96-300. Joint Institute for Marine and Atmospheric Research, Honolulu, Hawaii, USA, 59 pp.
- Ito, R., Machado, W. 2001. *Annual Report of the Hawaii-based Longline Fishery for 2000*. U.S. National Marine Fisheries Service Southwest Fisheries Science Center, Honolulu Administrative Report H-01-07, Honolulu, HI, USA.
- Ito, R., Machado, W. 1999. *Annual Report of the Hawaii-based Longline Fishery for 1998*. U.S. National Marine Fisheries Service Southwest Fisheries Science Center, Honolulu Administrative Report H-99-06, Honolulu, HI, USA.
- McCoy, M., H. Ishihara. 1999. *The Socioeconomic Importance of Sharks in the U.S. Flag Areas of the Western and Central Pacific*. Gillett, Preston and Associates, Inc., Honolulu, Hawaii, USA, and U.S. National Marine Fisheries Service Southwest Region Administrative Report AR-SWR-00-01, La Jolla, CA, USA. 117 pp.
- Pacific Ocean Producers. 2005. *Pacific Ocean Producers Commercial Fishing and Marine Supplies for the Asia-Pacific Region Catalog 2004-2005*. Pacific Ocean Producers, Honolulu, Hawaii, USA.
- U.S. National Marine Fisheries Service. 2005b. *2005 Report to Congress Pursuant to the Shark Finning Prohibition Act of 2000 (Public Law 106-557)*. U.S. National Oceanic and Atmospheric Administration, U.S. Department of Commerce, Washington, D.C. 52 pp.
- U.S. National Marine Fisheries Service. 2002. Fisheries off West Coast States and in the Western Pacific; Atlantic Highly Migratory Species; Fisheries of the Northeastern United States; Implementation of the Shark Finning Prohibition Act. *Federal Register* 67(28): 6194-6202.
- U.S. National Marine Fisheries Service. 2001. Endangered Species Act Section 7 Consultation Biological Opinion: Authorization of Pelagic Fisheries under the Fishery Management Plan for the Pelagic Fisheries of the Western Pacific Region.
- Watson, J., Foster, D., Epperly, S., Shah, A. 2005. Fishing methods to reduce sea turtle mortality associated with pelagic longlines. *Canadian Journal of Fisheries and Aquatic Sciences* 62.
- Western Pacific Regional Fishery Management Council. 2005a. *Pelagic Fisheries of the Western Pacific Region*. 2004 Annual Report. Honolulu, HI, USA.
- Western Pacific Regional Fishery Management Council. 2005b. *Fishery Ecosystem Plan for Pacific Pelagic Fisheries of the Western Pacific Region*. Western Pacific Regional Fishery Management Council, Honolulu, HI, USA, 215 pp.
- Western Pacific Regional Fishery Management Council. 2003. *Managing Marine Fisheries of the U.S. Pacific Islands. Past, Present, and Future*. Prepared by E. Gilman, ELG Environmental Services. WPFMC, Honolulu, HI, USA. 25 pp. Western Pacific Fishery Management Council.

## Appendix 9

### U.S.A. Atlantic, Gulf of Mexico and Caribbean Pelagic Longline Swordfish and Tuna Fisheries: Industry Practices and Attitudes towards Shark Depredation and Unwanted Bycatch

John W. Mandelman and Tim B. Werner, New England Aquarium,  
jmandelman@neaq.org, twerner@neaq.org

#### A9.1. Introduction

It is widely held that the incidental capture of sharks in fisheries targeting alternative species represents a massive challenge in the proper management of this group (Figs. A9.1 and A9.2) (Barker and Schluessel, 2004). Akin to the outcome in high-seas commercial fisheries around the globe, sharks compose the highest percentage of bycatch in the U.S. Atlantic PLL (PLL) fishery for swordfish, tunas and tuna-like species (Beerkircher et al., 2002). Although rarely targeted in U.S. domestic PLL operations, sharks and rays constituted 25% of the overall catch in this fishery between 1992 and 2003 according to observer data (Abercrombie *et al.*, 2005). If accounting for the other foreign fleets pelagic longlining in Atlantic waters, it has been estimated that the extent of shark bycatch by this capture method is considerably high, rivaling both the Indian and Pacific in terms of the number of individuals and overall shark biomass taken (Bonfil, 1994). Sharks are also among those responsible for inflicting damage (depredation) to baits, gear, and hooked targeted catch prior to haul-back in this fishery (Hoey and Moore, 1999). The species most commonly encountered in PLL operations are a variety of carcharhinids, and to a lesser extent, lamnid sharks. As several of these species are either prohibited from being landed or lack appreciable commercial value, discard rates are chronically high. For these reasons, interactions with sharks in the domestic PLL fishery are presumed as a relative nuisance; encumbering commercial operations for tuna and swordfish and afflicting fishermen with considerable costs through losses of and damage to gear, target catch (via depredation) and time.



Fig. A9.1. Longline captured *Isurus oxyrinchus* (shortfin mako shark), just prior to boarding (courtesy of Greg Skomal, Massachusetts Division of Marine Fisheries, USA).



Fig. A9.2. Longline captured *Prionace glauca* (blue shark), just after boarding (courtesy of Greg Skomal, Massachusetts Division of Marine Fisheries, USA).

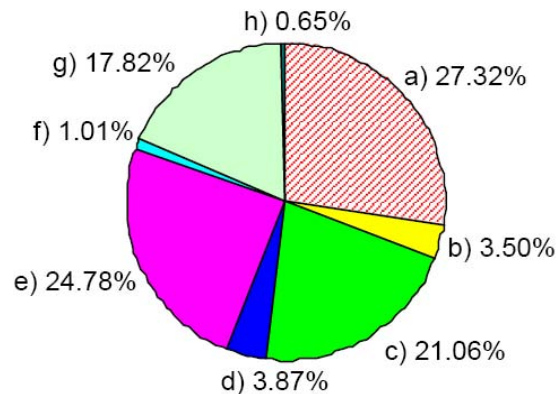

Fig. A9.3. Catch reported by scientific observers on U.S. longline vessels to the U.S. National Marine Fisheries Service Southeast Fisheries Science Center, 1992-2003 (Abercrombie *et al.*, 2005). a = swordfish; b = billfish; c = yellowfin, bigeye and bluefin tuna; d) other tunas; e = sharks and rays; f = unknown species; g = finfish; h = marine turtles, marine mammals and birds.

At the same time, physiological stress and physical trauma imposed during capture and handling can compromise the ultimate survival of discarded shark bycatch (Bonfil, 1994; Berkeley and Campos, 1988). If coupled with directed landings, discard mortality can elevate total fishing mortality (F) and imperil shark populations around the globe (Musick *et al.*, 2000). The control of unintended shark interactions is thus important not only for the operations of the longline fishing industry, but the health of interacting shark populations. Importantly, bycatch issues have been the basis of several regulatory measures imposed upon the Atlantic PLL fleet. It is therefore clear that mitigating the extent of incidental takes in this fishery, including those with sharks, will behoove industry, management and conservation communities alike.

In the following report, we address the estimated extent of shark bycatch, the species composition of this catch, and to a much lesser extent, shark depredation in the PLL fishery of the Atlantic, Caribbean and Gulf of Mexico (GOM). We also present ongoing research and potential strategies regarding the attenuation of shark interactions in this fishery. In doing so, several important factors regarding the data sources must first be addressed.

#### A9.1.1. Caveats in available data sets and reports

As recently as a decade ago, quantifying the extent of global shark bycatch and its impacts on population abundances was under-analyzed and viewed as an uncertain proposition (Bonfil, 1994). Although not to

the same extent as with cetaceans and sea turtles, management and conservation attention dedicated to incidental shark interactions in the U.S PLL fishery has heightened in recent years, providing the impetus to propagate a variety of reports, peer-reviewed publications, and documents addressing shark bycatch in this fishery. Recordings of shark landings and discards that constitute these reports/publications, such as those submitted to The International Commission for the Conservation of Atlantic Tunas (ICCAT), have been derived from a variety of data sources that were being collected prior to the onset of enhanced attention towards sharks. In relation to the U.S domestic fishery, these include dealer reports, tournament and weigh-out records, canvas data and most extensively Pelagic Observer Program (POP) data (since 1992) and mandatory fishermen logbook data (since 1982). Additionally, the Canadian Observer Program has also recorded catches in the Northernmost Atlantic. Despite attempts by certain authors to reconcile these data, the diversity in the reporting sources and multitude of confounding fishing, geographical, and reporting variables have limited the scope in or complicated the ability to draw sound conclusions (Crowder and Myers, 2001). In addition, the lack of emphasis on sharks in earlier years presumably resulted in more cases of non-reporting and misidentification. Additional confounding variables include the large geographic region encompassing the reporting areas, shifts in gear regimes, regulatory transitions, diversities in fishing strategies and/or target species, skewed data from disproportionately high sharks takes from limited but often uncharacteristic (and under-described) sets/conditions (Hoey and Moore, 1999), and in relation to abundance trends, the uncertainty in the rates of discard mortality for sharks following longline capture (Bonfil, 1994). As distinguishing between the possible species accountable for depredated target catch and/or bait is not always possible, establishing the rates of shark depredation in the PLL fishery has also proven irresolvable in associated reporting (Lawrence Beerkircher, personal communication).

Finally, many of the available documents have mined data from periods prior to the recent (2004) mandatory shifts relating to gear (e.g. hook-types) and baits, the ramifications of which are only beginning to be investigated in relation to shark interactions. An insufficient period of time has elapsed for complete industry acclimation to these new protocols and for any discernable shifts in catch-per-unit-effort (CPUE) to be reliably linked to this phase-shift.

Shark bycatch in the Atlantic PLL must be addressed for the sakes of both sustaining shark populations and the best interests of industry. Despite the aforementioned caveats associated with data collection, there is a plethora of work that has addressed shark bycatch in the Atlantic PLL fishery through which trends and conclusions can be established and new questions/objectives can emerge. We intend to consolidate the various works while highlighting key findings from the diverse array of available studies and unpublished analyses. Upon gauging the extent in which sharks interactions have been problematic in the Atlantic PLL fishery, subsequent mitigation strategies with global implications can be investigated.

#### **A9.1.2. Geographic fishing zones and status of the fleet**

The U.S. Atlantic, Caribbean and Gulf of Mexico PLL fishery is typically analyzed and managed according to 11 distinct zones spanning from the *Gulf of Mexico (GOM)* to the West, *Northeast Distant (NED)* to the North, to *Tuna South (TUS)* at the southern terminus (Fig A9.3) (NMFS, 2005). Within this geographic domain, there have conventionally been five sub-fisheries composing the overall domestic operation: the *Caribbean Island Tuna and Swordfish* fishery; the *Gulf of Mexico Yellowfin Tuna* fishery; the *South Atlantic Florida East Coast to Cape Hatteras Swordfish* fishery; the *Mid-Atlantic Swordfish and Bigeye Tuna* fishery; and the *U.S. Atlantic Distant Water Swordfish* fishery. A smaller-scale PLL operation also targets wahoo and dolphin in the Atlantic. These fishery “segments”, which are comprehensively described in the consolidated Highly Migratory Species Fishery Management Plan (HMS FMP) (NMFS, 2005), are diverse in their fishing regimes, gear-types, ranges and degree of transience, vessel numbers and sizes, and whether seasonal or perennial in operative nature.

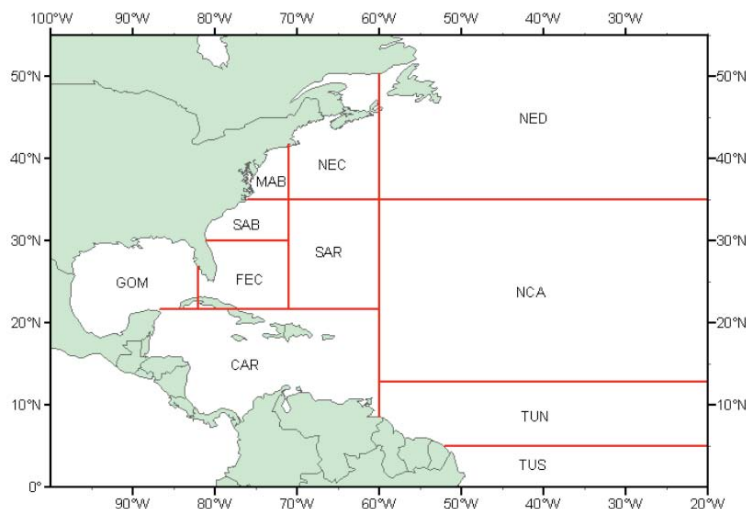

Fig. A9.4. Eleven areas used in analysis of the U.S. North Atlantic longline swordfish logbook data (PLTRT, 2006). CAR = Caribbean; GOM = Gulf of Mexico; FEC = Florida East Coast; SAB = South Atlantic Bight; MAB = Mid Atlantic Bight; NEC = Northeast Coastal; NED = Northeast Distant; SAR = Sargasso; NCA = North Central Atlantic Tuna; TUN = North; TUS = Tuna South.

Importantly, fishing by the U.S. domestic PLL fleet constitutes only a minute fraction (~10%) of the overall effort in the Atlantic. The majority of effort occurs in international waters by foreign fleets such as the Japanese. Although lobbied to do so by ICCAT, international fleets are not governed to abide by U.S. management policy regarding strategies to reduce bycatch of marine mammals and sea turtles (APLTRT, 2006). Nor are the data of landings and discards from these international operations proportionately reflected in domestic assessments. Most fishery data, like that applying to bycatch and shark interactions, are thus not accounting for the presumably high numbers encountered by international vessels. Strict regulations have also resulted in a decline in the numbers of permitted and operating vessels (Table A9.1) in the domestic fleet - there are approximately 80 to 100 active PLL vessels operating in the Atlantic Ocean, Gulf of Mexico, and Caribbean Sea at present (NMFS, 2006). As being "active" does not necessarily indicate a vessel actively fishing, the fleet is presumably curtailed even more than is reflected by vessel status. Accordingly, the degree of U.S. PLL effort and therefore shark interactions is likely diminutive in relation to that by international fleets in the Atlantic.

Table A9.1. Number of active U.S. vessels with swordfish permits based on logbook data, 1987-2003 (Abercrombie et al., 2005).

Year	Fished	Caught Swordfish	Caught Swordfish in 5 Months	Hooks
1987	297	273	180	6,557,776
1988	387	337	210	7,010,008
1989	455	415	250	7,929,927
1990	416	362	209	7,495,419
1991	333	303	175	7,746,837
1992	337	302	183	9,056,908
1993	434	306	175	9,721,036
1994	501	306	176	11,270,632
1995	489	314	198	10,976,048
1996	367	276	189	10,213,223
1997	350	264	167	10,212,823
1998	286	231	134	7,886,088
1999	224	199	140	7,768,790
2000	199	181	129	7,876,642
2001	184	168	113	7,889,137
2002	150	139	103	7,262,384
2003	127	119	94	7,164,698

### A9.1.3. Gear types

Although varied according to target species and conditions, the gear typically employed by domestic PLL fleet is of the “Florida” style that has been well described in previous documents (e.g. NMFS, 2005). However, various gear (and bait) requirements to be described in the sections that follow, have been instituted in recent years to mitigate bycatch of marine mammals and sea turtles (APLTRT, 2006).

### A9.1.4. Management parameters

The management of Atlantic highly migratory species in the United States is dually governed by the Magnuson-Stevens Fishery Conservation and Management Act (reauthorized as the Sustainable Fisheries Act) and Atlantic Tunas Convention Act (ATCA) (NMFS, 2005). Pelagic species other than istiophorid billfishes have been managed under the Fishery Management Plan for Atlantic Tunas, Swordfish, and Sharks (ATSS FMP; NMFS, 1999). However, a proposal to merge this FMP with the Atlantic Billfish FMP (implemented in 1988) is currently pending. If adopted, the new consolidated HMS FMP would also institute additional management actions, including additional bycatch mitigation strategies. The basis for these inclusions centers on, among other facets, the adoption of regulations upheld and/or recommended by international bodies. For instance, the ATCA includes provisions that authorize NMFS the ability to promulgate actions/changes recommended by ICCAT in regard to HMS in the Atlantic (APLTRT, 2006).

Table A9.2. Summary of bycatch species in pelagic longline fishery, Marine Mammal Protection Act (MMPA) category, Endangered Species Act (ESA) requirements, data collection and management measures (modified from NMFS (2004)).

Fishery/Gear Type	Bycatch Species	MMPA Category	ESA Requirements	Bycatch Data Collection	Management Measures
Pelagic Longline	Bluefin tuna Billfish Undersize target species Marine mammals Sea turtles Seabirds Non-target finfish Prohibited shark species Large Coastal Shark species after closure	Category I	Jeopardy finding in 2000, Reasonable and Prudent Alternative implemented 2001	Permit requirement (1985); logbook requirement (SWO- 1985; SHK - 1993); observer requirement (1992), EFPs (2001, 2002, 2003)	BFT target catch Requirements (1981); quotas (SWO - 1985; SHK - 1993); prohibit possession of billfish (1988); minimum size (1995); gear marking (1999); line clippers, dipnets (2000); MAB closure (1999); limited access (1999); limit the length of mainline (1996- 1997 only); move 1 nm after an interaction (1999); voluntary vessel operator workshops (1999); GOM closure (2000); FL, Charleston Bump, NED closures (2001); gangion length, corrodible hooks, dehooking devices, handling & release guidelines (2001); NED experiment (2001); VMS (2003)

### A9.1.5. Shark management

In general, the extent of U.S. management attention dedicated to sharks is considerable. In addition to ICCAT reporting, this can also be attributed to the establishment of the ATSS FMP, the International (FAO, 1999) and U.S. (NMFS, 2001) Plans of Action for the Conservation and Management of Sharks, and additional publications reporting alarmingly heavy declines in global shark populations (e.g. Baum et al., 2003). From 1993 until the approval of the ATSS FMP, shark management in the Atlantic PLL fishery had abided by the Federal Management Plan for Sharks of the Atlantic Coast (NMFS, 1993; 2006). This plan established the following categorical designations for the management of sharks based upon typical domains and morphometric characteristics: small coastal; large coastal; and pelagic sharks (Table A9.3). The FMP also instituted several measures including an indirect ban on “finning”. In 1999, the ATSS FMP was implemented, heightening management priority in the Atlantic PLL fishery for sharks through such

acts as instituting bag limits and size quotas (NMFS, 2006). Amendment #1 to this FMP (NMFS, 2003) provided further supplementation, enforcing limitations on fishing through areas closures and additional policies. In addition, NMFS prohibited PLL fishing in the Florida East Coast, Charleston Bump, DeSoto Canyon, and Grand Banks areas beginning in 2000 and 2001 as a means to reduce bycatch of swordfish, billfish, and sea turtles (Fig. A9.4) (Abercrombie et al., 2005; NMFS, 2006). Although an incidental consequence, the restricted ability to fish also prevents taking sharks in these geographic areas. Concurrently, the Shark Finning Prohibition Act (2000, 2002) enforced tight restrictions against the exclusive take of fins from individual animals (NMFS, 2006).

Table A9.3. Shark species comprising U.S. Atlantic (domestic) management units (Bonfil, 1994).

	<b>FAO Common Name</b>	<b>Scientific Name</b>
<b>Large Coastal Sharks</b>	Sandbar	<i>Carcharhinus plumbeus</i>
	Blacktip	<i>Carcharhinus limbatus</i>
	Dusky	<i>Carcharhinus obscurus</i>
	Spinner	<i>Carcharhinus brevipinna</i>
	Silky	<i>Carcharhinus falciformis</i>
	Bull	<i>Carcharhinus leucas</i>
	Bignose	<i>Carcharhinus altimus</i>
	Copper	<i>Carcharhinus brachyurus</i>
	Galapagos	<i>Carcharhinus galapagensis</i>
	Night	<i>Carcharhinus signatus</i>
	Caribbean reef	<i>Carcharhinus perezi</i>
	Tiger	<i>Galeocerdo cuvier</i>
	Lemon	<i>Negaprion brevirostris</i>
	Sandtiger	<i>Carcharias taurus</i>
	Bigeye sand tiger	<i>Odontaspis noronhai</i>
	Nurse	<i>Ginglymostoma cirratum</i>
	Scalloped hammerhead	<i>Sphyrna lewini</i>
	Great hammerhead	<i>Sphyrna mokarran</i>
	Smooth hammerhead	<i>Sphyrna zygaena</i>
	Whale	<i>Rhincodon typus</i>
Basking	<i>Cetorhinus maximus</i>	
Great White	<i>Carcharodon carcharias</i>	
<b>Small Coastal Sharks</b>	Atlantic sharpnose	<i>Rhizoprionodon terraenovae</i>
	Caribbean sharpnose	<i>Rhizoprionodon porosus</i>
	Finetooth	<i>Carcharhinus isodon</i>
	Blacknose	<i>Carcharhinus acronotus</i>
	Smalltail	<i>Carcharhinus porosus</i>
	Bonnethead	<i>Sphyrna tiburo</i>
	Sand devil	<i>Squatina dumeril</i>
<b>Pelagic Sharks</b>	Shortfin mako	<i>Isurus oxyrinchus</i>
	Longfin mako	<i>Isurus paucus</i>
	Porbeagle	<i>Lamna nasus</i>
	Thresher	<i>Alopias vulpinus</i>
	Bigeye thresher	<i>Alopias superciliosus</i>
	Blue	<i>Prionace glauca</i>
	Oceanic whitetip	<i>Carcharhinus longimanus</i>
	Sharpnose sevengill	<i>Hepttranchias perlo</i>
	Bluntnose sixgill	<i>Hexanchus griseus</i>
Bigeye sixgill	<i>Hexanchus vitulus</i>	

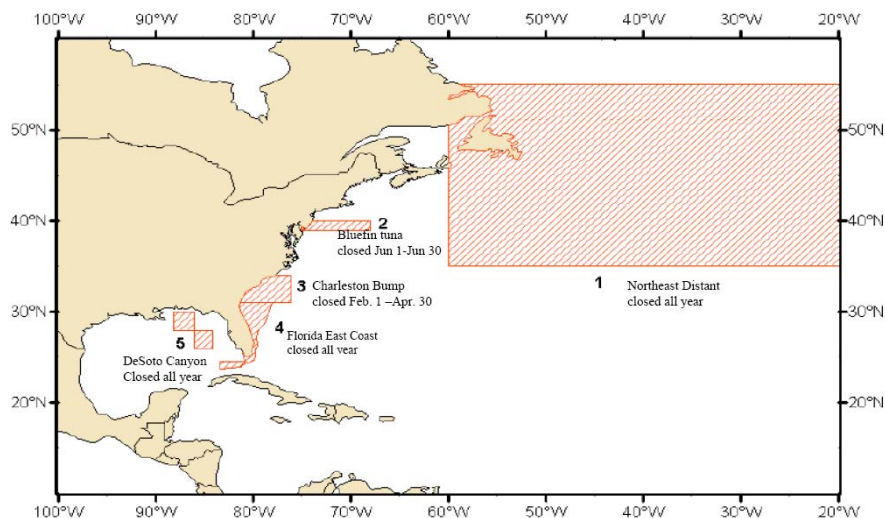

Fig A9.5. Atlantic pelagic longline fishery time - area closures: 1= Northeast Distant area; 2 = Bluefin Tuna area; 3 = Charleston Bump area; 4 = Florida East Coast (FEC) area; 5 = DeSoto Canyon area (Abercrombie *et al.*, 2005).

At present, sharks can only be retained during three seasons in which associated quotas are equally allocated. Several species encountered during fishing operations must be discarded universally with minimized injury and without removal from the water (NMFS, 2003). The collective prohibited large coastal and pelagic species most likely to be encountered during PLL operations include *Carcharhinus signatus* (night shark), *Carcharhinus obscurus* (dusky shark), *Isurus paucus* (longfin mako shark) and *Alopias superciliosus* (bigeye thresher shark). Conversely, several species caught in U.S. PLL operations can be retained assuming adherence to accompanying regulations. These include large coastal sharks such as *Carcharhinus plumbeus* (sandbar shark), *Galeocerdo cuvier* (tiger shark) and *Carcharhinus falciformis* (silky shark) as well as pelagic sharks such as *Isurus oxyrinchus* (shortfin mako shark), *Alopias vulpinus* (common thresher shark), *Lamna nasus* (porbeagle shark), *Carcharhinus longimanus* (oceanic whitetip shark) and *Prionace glauca* (blue shark) (NMFS 2004).

Importantly, there is yet a U.S./ICCAT management system in place for the sharks taken in international waters by non-U.S. vessels, where a high proportion of the shark landings in the Atlantic occur via foreign fleets (Crowder and Myers, 2002).

## A9.2. Incidental Shark Takes in the Atlantic

### A9.2.1. General takes according to species

Although routinely caught in Atlantic PLL operations, shortfin mako, and common thresher sharks will not be addressed to the same degree here. Due to existing market values, these species and to a lesser extent select coastal species, represent the elasmobranchs more regularly landed when caught by U.S. domestic LL operations during open seasons. Although not necessarily targeted as the sole basis of trip as are tuna or swordfish (and thus still considered bycatch by definition), the incidental capture of these species is not viewed with same futility as is that of a tiger or blue shark. This also applies to trips where sharks are finned and remaining carcasses discarded by foreign fleets in international waters. Although landings and illegal finning are topics worthy of extensive attention, this report will proceed under the assumption that interactions are not desired.

Many reports pertaining to the U.S. Atlantic PLL fishery, most notably those submitted to ICCAT, have addressed shark landings and bycatch since the mid-1990s, when the management of sharks began receiving heightened attention. The aforementioned POP and mandatory logbook data have been the



dominant data sources for the bulk of this output, with several other sources providing valuable direct or ancillary data. Although widely diverse in aim and scope, relevant works are tabulated and summarized herein (Table A9.4). Documents related to the Canadian PLL industry and foreign fleets in the Atlantic are also represented. Although detailed synopses of each of these works are not germane to this report, selected principal findings warrant inclusion.

Table A9.4. Chronological by year and alphabetical by author, a matrix of selected post-1990 peer-reviewed publications, reports and documents that have addressed CPUE, catch composition, associated abundance indices, and other factors related in one aspect or another to shark bycatch in the Atlantic pelagic LL fishing industry. This includes a very limited sample of documents pertaining to Canadian fisheries in the North Atlantic and foreign fleets in the Atlantic. Note that this tabulates an extensive sample of available “grey” and primary literature but may not represent the full extent of all relevant citations, especially in relation to reports to ICCAT, FAO reports on shark takes by foreign fleets in the Atlantic, and earlier papers preceding 1990. In addition, a plethora of papers related to this topic have addressed longline fisheries in other oceans; only the Atlantic, GOM and Caribbean are covered here. **Bolded** author names denote a peer-reviewed paper from the primary literature. Otherwise, the citation is a technical report submitted to ICCAT, or an alternative technical report/document.

<b>Author(s)</b>	<b>Year</b>	<b>Title</b>	<b>Primary data Source(s)</b>	<b>Notes</b>
Bonfil	1994	Overview of world elasmobranch fisheries	Literature, available reports	Written prior to when shark bycatch in high seas fisheries was getting more attention both in U.S. domestic circles and international forums. Provides a thorough overview of why it is challenging to assess the true extent and impacts of shark capture in pelagic LL fisheries.
Nakano and Honma	1996	Historical CPUE of pelagic sharks caught by the Japanese longline fishery in the Atlantic ocean	Japanese logbook data	Shark catch by this fleet is assessed in a time series that reveals only minor changes in shark CPEU between historical and modern records (1971-1994).
Cramer	1997	Large pelagic logbook catch rate indices for sharks	U.S. Logbook	Abundance indices from 1986-1995; trends for additional species added to logbook reporting system analyzed from 1992-1997.
Cramer	1997	Estimates of the numbers and metric tons of sharks discarded dead by pelagic longline vessels	U.S. logbook; POP; Weighout records	Dead shark discards reported from 1986 to 1995 with post 1990 data obtainable from observer reports from NMFS.
Cramer	1997	Bycatch of blue sharks ( <i>Prionace glauca</i> ) reported by U.S. longline vessels from 1987-1995	U.S. logbook; POP	Reports on this heavily discarded species from 1987-1995 where catchability during the latter portion of this time series increased, especially on the Grand Banks.
Cramer <i>et al.</i>	1997	Estimates of recent shark bycatch by U.S. vessels fishing for Atlantic tuna and tuna-like species	POP; U.S. Logbook	Estimates of shark by-catch, disposition and catch characteristics in 1996. Comparisons made with earlier reports characterizing the earlier 1990s.
Scott	1997	Recent trends in catch rates of some Atlantic sharks	SEFSC	CPUE and qualitative assessments of individual species life history characteristics used to derive the relative risks of recovery in coastal and pelagic sharks.
Hoey and Moore	1999	Captain’s report: multi-species catch characteristics for the U.S. Atlantic pelagic longline fishery	POP	Comprehensive report quantifying catch rates; catch disposition by reporting area; and nominal catch rates/species distributions with special attention devoted to sharks. Presents data-driven recommendations to reduce the extent of shark bycatch.

Cortés	2000	Catch rates of pelagic sharks from the Northwestern Atlantic, Gulf of Mexico and Caribbean	U.S. Logbook; Weighout records; Observer reports from international vessels	CPUE time series summarized for pelagic sharks. Reflects both commercial and recreational; bottom and pelagic LL; and domestic and international catches.
Cramer	2000	Large pelagic logbook catch rates for sharks	U.S. Logbook	Indices of abundance from 1986-1997. Does not discriminate between pelagic and bottom longline fisheries.
Cramer <i>et al.</i>	2000	Shark by-catch from the U.S. Longline Fleet 1982 through 1992	POP; U.S. Logbook; Landings records	Encompasses wide geographic range in W. Atlantic. Taps into earliest logbook recordings for the most prolonged temporal assessment to date at that time.
Crowder and Myers	2001	Sharks (Chap. 6 in) Report to Pew Charitable Trusts: a comprehensive study of the ecological impacts of the worldwide pelagic longline industry.	U.S Logbook	Report on targeted and incidental shark catches in the Atlantic and conclude declines in abundance of several species on the basis of decreasing CPUEs (state that conclusions assume a proportional relationship between CPEU and abundance).
Baum <i>et al.</i>	2002	Preliminary standardized catch rates for pelagic and large coastal sharks from logbook and observer data from the Northwest Atlantic	POP; U.S. Logbook; additional from both domestic and foreign fleets in U.S. and Canadian waters; Canadian Observer Programs and logbook data	Focuses on catch rates as a determinant of abundance trends in sharks caught in the pelagic LL fisheries. Although stated to be difficult to establish trends through the combined analyses of both U.S. and Canadian data, several sharks reported as having undergone declines in recent years.
<b>Beerkircher <i>et al.</i></b>	2002	Characteristics of shark bycatch observed on pelagic longlines off the southeastern United States, 1992-2000	POP	Mines observer data from two of 11 fishing zones in the Atlantic to quantify and characterize shark bycatch in the fishery. Elasmobranchs constituted 15% of total catch with silky sharks the most dominant numerically. Quantifies and compares shark catchability by season (quarter), species, fork length, gender, and quantifies boarding (at vessel) mortality status of shark catch (by species).
Cortés	2002	Catches and catch rates of pelagic sharks from the Northwestern Atlantic, Gulf of Mexico, and Caribbean	POP; U.S. Logbook; Weighout sheets; Recreational data via Large Pelagic	Presents discard estimates and dead discard estimates for pelagic sharks. In addition to commercial time series, recreational time series also addressed.

DFO	2002	Catch, bycatch and landings of blue sharks in the Canadian Atlantic	Survey (LPS) International Observer Program (IOP); ZIF	Blue sharks constitute an almost solely bycatch fishery. Blue shark bycatch percentages reported for the Canadian tuna and swordfishery fishery, porbeagle shark fishery and Japanese large pelagic fishery.
Hoey <i>et al.</i>	2002	Pelagic shark abundance indices based on fishery-dependent and fishery-independent data from the western North Atlantic	Fishery-independent data; U.S. observers on Japanese vessels; POP; DFO observers on Japanese vessels	Blue and shortfin mako sharks focused upon. Includes discussions regarding how to relate older data sets from difference sources with more recent series.
<b>Simpfendorfer <i>et al.</i></b>	2002	Results of a fishery-independent survey for pelagic sharks in the western North Atlantic	Fishery-independent survey	CPUE and auxiliary factors used to assess biology and distribution of pelagic species in NW Atlantic. Comparisons made with fishery-dependent data and extensive attention dedicated to the blue shark
<b>Baum <i>et al.</i></b>	2003	Collapse and Conservation of shark populations in the Northwest Atlantic	U.S. Logbook	Reports on the decline of several coastal and pelagic sharks; abundance trends derived through CPUEs.
<b>Baum and Myers</b>	2004	Shifting baselines and decline of pelagic sharks in the Gulf of Mexico	(1954-57) Exploratory pelagic longline cruises; (1990s) POP POP	Catch rates standardized and compared between two time periods (50s vs. 90s) in the GOM. Estimations of sharp declines in silky and oceanic whitetip populations.
Beerkircher <i>et al.</i>	2004	SEFSC Pelagic Observer Program data summary fro 1992-2002	POP POP	A comprehensive summation of POP data that includes shark catch data and depredated/live/dead catch data (without resolution of which species was source of depredation). Although not explicitly addressed here, has been a reliable data source for several subsequent reports addressing shark bycatch.
Brooks <i>et al.</i>	2005	Standardized catch rates for blue shark and shortfin mako shark from the U.S pelagic logbook and U.S. pelagic observer program, and U.S weighout landings	POP; U.S. Logbook; weighout-landings	POP and logbook data both illustrate a decline in blue shark catches over time. This decline may indicate a change in catchability or a change in abundance.
Campana <i>et al.</i>	2005	Catch, by-catch and indices of population status of the blue shark ( <i>Prionace glauca</i> )	Scotia-Fundy Observer Program (SFOP)	Foreign fishing efforts also accounted for; Blue shark catch almost all discarded; catches heavily underreported since many are cut-offs and bite-offs prior to reaching deck; mortality high through landings

		in the Canadian Atlantic		and discard mortality; although resilient, indications are that populations have declined in Canadian Atlantic in recent years. Addresses incidental capture and discard across fisheries. Independently report on the pelagic LL fishery and sharks.
Harrington <i>et al.</i>	2005	Wasted Resources: bycatch and discards in U.S. fisheries	POP (in relation to pelagic discards)	
Matsunaga and Nakano	2005	Estimation of shark catches by Japanese tuna longline vessels in the Atlantic ocean	Japanese logbook data	Emphasizes species differences. Most noteworthy is a decreasing trend in shark CPEU by Japanese vessels since the mid-1990s, before which time CPUE had been relatively stable since the early 1970s.
Senba and Nakano	2005	Summary of species composition and nominal CPUE of pelagic sharks based on observer data from the Japanese longline fishery in the Atlantic Ocean from 1995 to 2003	Japanese observer data	Species and catch rates summarized from specific six specific regions in the Atlantic; blue shark catch rates were highest across species, most notably in the Northwest Atlantic area that included the Grand Banks.
<b>Diaz and Serafy</b>	2005	Longline-caught blue shark ( <i>Prionace glauca</i> ): factors affecting the numbers available for live release	POP	Expansion of previous investigations into the effects of LL soak time by introducing the effects of fish size, set duration, and water temperature on shark survival following longline capture
<b>Campana <i>et al.</i></b>	2006	Effects of recreational and commercial fishing on blue sharks ( <i>Prionace glauca</i> ) in Atlantic Canada, with inferences on the North Atlantic population	SFOP; tournament catch records	Similar to Campana <i>et al.</i> (2005) ICCAT document, integrating recreational component through tournament records.
Diaz	2006	Estimation of large coastal sharks dead discards for the US pelagic longline fishing fleet	POP; U.S. Logbook	The amount of dead discarded shark carcasses estimated by species for the year 2004.
NMFS	2006	Annual Report of the United States of America	U.S. Logbook*	* In relation to shark discards only (many additional data sources are utilized throughout report) in the section on shark fishery statistics. Presents temporal data on blue and mako shark landings and discard numbers.

---

Independent of region, blue sharks represent by far the most heavily captured shark in U.S. Atlantic PLL operations, constituting 17-32% of the universal catch reported in this fishery between 1987 and 1995 (Cramer, 1997C). This is consistent with the findings from fishery-independent data sources that blue sharks represent by far the most abundant pelagic shark in the Northwest Atlantic (Simpfendorfer *et al.*, 2002). The species reportedly comprises 50% of the universal Northwest Atlantic PLL bycatch, a group of species not comprised exclusively of sharks (Crowder and Myers, 2001). A virtually unwanted species in tuna and swordfish operations, blue shark discards peaked at an estimated 29,000 individuals in 1993 (NMFS, 2006). As of 2000, predicted annual discards for the species were set at 1,575 metric tons (mt) based on POP data (Harrington *et al.*, 2005). In comparison, silky shark discards (mt) were predicted to be (163); dusky (113); sandbar (40); bigeye thresher shark (39); and *Sphyrna lewini* (scalloped hammerhead) (32) (Harrington *et al.*, 2005). In an analysis by Hoey and Moore (1999) of the POP data spanning 1990-1997, the following positively identified shark species were captured in descending order by number while excluding all other factors: blue (19,264); silky (1,905); mako (1,726); dusky (1,122); hammerhead (multiple sp., 725); tiger (351); common thresher (348); sandbar (333); oceanic whitetip (262); *Carcharhinus limbatus* (blacktip) (92); and porbeagle (45). When taking into account the relative scarcity of blue sharks in more Southern tropical fishing zones (e.g. GOM), the magnitude of these disparities highlights both the comparative dominance of blue versus other shark species as bycatch in this fishery, and the disproportionate numbers of blue sharks taken in their prevalent take zones.

It has been reported that Canadian observers may only be documenting blue shark catches brought on deck, a predicament not accounting for the leader bite-offs prior to boarding (DFO, 2002; Campana *et al.*, 2005). Thus, blue shark catches may also be grossly underreported in that fishery, an outcome not implausible for the U.S domestic fishery as well. However, this species appears quite resilient to the rigors of longline capture. Low boarding (at-vessel) blue shark mortality has been observed, where dependent upon the study, 7-19% of the all blue shark discards were deemed alive at the time of release (e.g. Cramer 1997C; Campana *et al.*, 2005). Logbook data have reported an oscillating but nevertheless declining trend in blue shark catch numbers during recent years (Crowder and Myers, 2001; NMFS, 2006). Thus, in studies equating catchability (CPUE) with indices of abundance, Atlantic blue sharks are among those species reported to have undergone considerable population declines (Baum *et al.*, 2003). In accordance with previous arguments against treating CPUE as an index of abundance (Cooke and Beddington, 1984), the extent of the reported blue shark decline (~60% since 1986) postulated by Baum *et al.* (2003) has been questioned by several authors (e.g. Campana *et al.*, 2005) on the basis that potential reasons for drops in CPUE aside from abundance declines were not accounted for. It is acknowledged, however, that the species has likely endured some level of decline in recent years (Brooks *et al.*, 2005; Campana *et al.*, 2006). Considering its comparatively high fecundity in relation to most other sharks, even a minimal decline would suggest that blue sharks, even if released alive, may be dying at a higher rate following PLL capture and discard than presumed. If the supposition is true that virtually all blue sharks are discarded alive with a high ultimate rate of survivability, the declines in abundance surmised by certain authors would only be conceivable due to a climb in natural mortality or an increase in landings of the species by non-U.S fleets in N. Atlantic high seas fisheries. This area warrants further investigation.

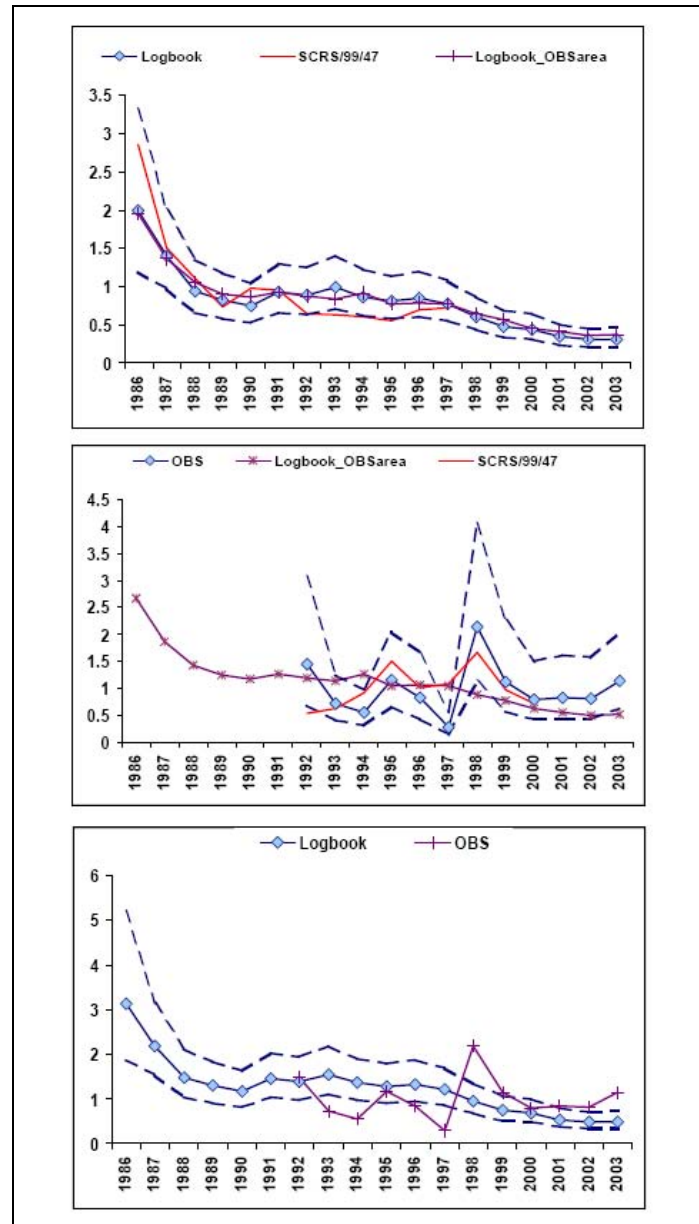

Fig. A9.6. Standardized CPUE (number per 1000 hooks) and 95% confidence intervals for blue shark. All indices are standardized to the mean of the overlapping years (Brooks *et al.*, 2005).

Aside from the blue shark, recent declining trends in CPUE for other shark species caught in the U.S. Atlantic PLL fishery have been reported (e.g. Baum *et al.*, 2003; Baum and Myers, 2004). A similar pattern since the mid-1990s has been echoed via observer reports from Japanese vessels operating in the Atlantic (e.g. Senba and Nakano, 2005). Although whether a true reflection of declines in abundance is a topic beyond the scope of this report, the decreases in catchability could be explained by underreporting, increased bite-offs from lighter gear (Brooks *et al.*, 2005) and the historical use of J-hooks, changes in observed fishing effort through alternate shifts in gear or fishing distribution (Beerkircher *et al.*, 2002), and most speculatively, the potentially successful establishment of personal fishing strategies and gear configurations by industry to reduce shark interactions.

#### A9.2.2. Takes according to region and alternative factors

Independent of seasonal and geographic factors, the highest rate of blue shark catch (spanning 1990-1997) coincided with swordfish as opposed to tuna targeted effort according to observer data (Hoey and

Moore, 1999). Under the same conditions, swordfish were generally targeted in sets deployed between 2:00PM and 10:00PM with retrieval sometime between 4:00AM and 10:00AM. Alternatively, deployment and retrieval of tuna-targeted sets occurred at 2:00AM-12:00PM and 4:00PM-12:00AM respectively (Hoey and Moore, 1999). Although this could imply that blue sharks are more readily caught in the dusk to late evening hours and less frequently so in the early morning and daylight hours, the concordance between their catch rates and those of swordfish could also be a function of the high abundance of blue shark on the Grand Banks where swordfish have conventionally been the primary target species of the Northeast Distant (NED) fleet.

The CPUE of blue sharks on the Grand Banks peaks in the summer months with reported rates of 0.10 (Cramer, 1997C). This differs with the CPUE estimates of 0.001 in more southeast zones (GOM, SAB, and FEC). As a function of the high catch rates for the species in the Northeast distant areas like the Grand Banks, Canadian fisheries account for a very high overall percentage of blue shark bycatch (DFO, 2002).

Coupled with season and depth, behavioral thermoregulation also appears to be an important variable dictating the catch rates of blue sharks (John Hoey, personal communication). Although highly migratory and able to tolerate a wide array of temperature gradients, the species tends to prefer more temperate zones. Catch rates of blue sharks have been found to decline by 9.7-11.4% in response to an only 0.6 °C increase in sea surface temperature (Watson *et al.*, 2005). Not surprisingly, it has also been shown that blue sharks tend to prefer sub-surface depths that possess cooler temperatures (e.g. Simpfendorfer *et al.*, 2002). However, more comprehensive studies on blue shark distribution according to full water column temperature profiles and thermocline dynamics are necessary before amending fishing practices in accordance with patterns in sea-surface temperatures.

In a study which assessed catch characteristics in two southeastern zones, a more standardized CPUE estimate than could be assigned if encompassing more areas, was derived for the aggregate of shark species captured in PLL operations from 1992-2000 (Beerkircher *et al.*, 2002). As referenced, silky sharks are second only to blue sharks in the total number of catches in this fishery. However, in assessments of the SAB and FEC exclusively, silky sharks were the predominant species taken (Beerkircher *et al.*, 2002). Dusky and night sharks also exceeded blue sharks for CPUE and overall catch numbers. Quarterly deviations in CPUE also exist for several species with silky shark catch rates the highest in the 1<sup>st</sup> and 4<sup>th</sup> quarters of the year (Table A9.5). Comparable to the aforementioned declines in blue shark and alternate species CPUE in recent years, these authors also report a 1992-2000 decline when weighed against 1981 to 1983 estimates taken from Berkeley and Campos (1988) (Table A9.6). These downward trends may reflect shifts in abundance but could also be indicative of spatial and gear factors that have served to reduce catchability (Beerkircher *et al.*, 2002).

Table A9.5. Quarterly CPUE (numbers per 1,000 hooks) and significant relationships observed in the pelagic longline fishery off the southeastern U.S., 1992–2000 (Beerkircher *et al.*, 2002).

Species	CPUE				Quarterly relationship(s)	P
	QTR 1	QTR 2	QTR 3	QTR 4		
Silky	5.38	3.22	3.16	4.28	4>2	0.001
Dusky	1.50	3.09	1.94	1.10		
Night	1.48	1.62	0.30	0.28	1,2>3,4	0.0001
Blue	1.29	1.51	0.09	0.41	1,2>3,4	0.0001
Unidentified	0.58	1.04	0.63	0.62		
Tiger	0.57	0.64	0.93	0.87		
Scalloped hammerhead	0.63	0.83	0.78	0.62		
Oceanic whitetip	0.16	0.16	0.51	0.90	4>3>1,2	0.0001
Rays	0.28	0.09	0.45	0.49	4,3,1>2	0.0001
Sandbar	0.21	0.59	0.30	0.07	2>1,4	0.0002
Bigeye thresher	0.23	0.26	0.26	0.16		
Shortfin mako	0.41	0.19	0.18	0.16	1>2,3,4	0.01



Table A9.6. Overall nominal CPUE (numbers caught per 1,000 hooks) off the southeastern U.S. Data for 1981–83 are from Berkeley and Campos (1988); 1992–2000 data are from (Beerkircher et al., 2002).

Species	CPUE	
	1981-83	1992-2000
Silky	11.22	3.49
Dusky	0.47	1.64
Night	10.75	1.36
Blue	0.60	1.05
Unidentified	0.87	0.66
Tiger	0.60	0.64
Scalloped hammerhead	13.37	0.48
Oceanic whitetip	0.87	0.32
Sandbar	0.07	0.28
Bigeye thresher	0.67	0.20
Shortfin mako	0.00	0.19

Based on the catch disposition figures derived by Hoey and Moore (1999), rankings of the highest weight of shark species caught by area have been tabulated (Table A9.7). Greater resolution of these rankings reveals that apart from the MAB, NEC and NED, a shark species or group never exceeded 100,000 pounds in a given area during the collective years covered in the report (1990-1997). In over half of the areas, the most captured shark by weight didn't exceed ~ 20,000 lbs. Because in rare instances, disproportionately high numbers of sharks were caught when fishermen shifted to directed shark fishing (Hoey and Moore, 1999), the degree of shark bycatch (excluding shortfin makos) was likely even lower than the figures allude. However, the magnitude of overall catch weight, data only representative of when observers were present, is secondary. What is most germane is that fishing in certain regions will lead to increased shark encounters. Moreover, despite constituting the primary aggregate of bycatch species in the PLL fishery (e.g. Beerkircher *et al.*, 2002), shark catches aside from those of blue sharks, do not appear exorbitantly high in U.S. domestic operations; at least when compared to the catches by foreign fleets.

Table A9.7. Ranked order of sharks by species (blue and shortfin mako) or general categories designated by Hoey and Moore (1999), taken by pelagic LL between 1990 and 1997 by region. Derived from data in Hoey and Moore (1999).

Geographic Zone*	Rank I	Rank II	Rank III
NED	Blue shark	Other pelagic sharks	Large coastals
NEC	Blue shark	Large coastal sharks	Mako sharks
MAB	Blue shark	Large coastal sharks	Mako sharks
SAB	Large coastal sharks	Blue sharks	Other pelagic sharks
FEC	Blue sharks (< 20,000 lbs)	Mako sharks	Other pelagic sharks
GOM	Mako sharks (~20,000 lbs)	Other sharks	Other pelagic sharks
WNCA <sup>†</sup>	Blue shark (< 50,000 lbs)	Mako sharks	Other pelagic sharks
CAR	Blue sharks (< 15,000 lbs)	Large coastal sharks	Other pelagic sharks
TROP <sup>a</sup>	Blue sharks ~ 20,000 lbs)	Other sharks	Large coastal sharks

### A9.2.3. Shark depredation

In addition to being captured as bycatch, sharks are also responsible for removing baits and gear (bite-offs) and inflicting damage upon other catch already hooked and thus less able to avoid predation. Depredation thus represents a major nuisance to fishermen. To the detriment of industry, POP data

indicates that of all damage between 1990 and 1997 (4% of total observed catch), 68% occurred on catches of swordfish, yellowfin and bigeye tuna collectively (Hoey and Moore, 1999). Although damaged catch has been reported in assessments of catch disposition by several authors (e.g. Hoey and Moore, 1999; Beerkircher *et al.*, 2004; Diaz, 2006; Kerstetter and Graves, 2006B), the available data are not usually resolvable to a level where possible to definitively identify the depredating species (Lawrence Beerkircher, personal communication). The point of interaction is rarely observed to enable positive identification. In addition to sharks, cetaceans (Hoey and Moore, 1999) are also responsible for damaging catch and pilfering baits and gear. In fact, depredation by marine mammals could equal or even exceed that done by sharks in certain areas such as the MAB (Lawrence Beerkircher, personal communication). To facilitate the ability to distinguish between the depredating species, NMFS is implementing a new data collection protocol requiring more comprehensive reporting details in early 2007 (Lawrence Beerkircher, personal communication). However, even if able to distinguish between damage done by sharks and other animals, interspecific identification of the depredating animal will likely remain impossible. If such data are deemed as important, accounting for auxiliary factors such as the CPUE, abundance, distribution, and behavioral tendencies of potentially depredating species may strengthen the ability to identify the source species.

Importantly, depredations on target or alternative catch may not always be accounted for. In cases where soak times are protracted, animals that die or are weakened from stressors experienced while hooked are much easier targets for scavenging species such as blue sharks (Ward *et al.*, 2004). Thus, reducing soak-times is a straightforward method that could possibly mitigate both shark catch rates and depredation.

### **A9.3. Potential Strategies to Reduce Shark Interactions and Mortality**

#### **A9.3.1. That related to other taxa or fisheries**

A comprehensive Atlantic PLL Take Reduction Plan (APLTRP) was recently submitted to NOAA (2006). Although not directly addressed, it is conceivable that some of the measures intended by the Take Reduction Team (TRT) to reduce the number of serious injury interactions with pilot whales and Risso's dolphins could also be successfully applied to sharks. The applicable proposals described in the APLTRP include proper handling protocols; mandatory mainline, gear and bait requirements to be discussed in greater detail shortly; and additional time-area closures.

There are also existing regulations applying to the Atlantic and GOM bottom longline fishery that may be effective tools in increasing post-release survival for sharks taken by PLL (APLTRT, 2006). These include the rapid release of non-retained species with an immediate retrieval of gear remaining deployed; the use of line-cutters and dip-nets for release purposes; and the maintenance of seawater flow across the gills (as must be maintained in sawfish caught by bottom longline). However, these should be viewed as techniques that could potentially reduce the detrimental effects from, rather than the rates of, interactions.

#### **A9.3.2. That related to pelagic operations**

POP data, as previously reported upon by Hoey and Moore (1999), have revealed sets yielding disproportionately high shark catches. In some instances, PLL fishermen have reportedly altered operative strategies in order to land increased numbers of sharks. Alternatively, a particular set of conditions may translate into higher catch rates. Independent of whether or not intended however, these particular sets can be analyzed for environmental and operative factors that may have contributed to the higher catch rates. Accounting for such variables could prove beneficial to industry if deriving measures to help circumvent high numbers of shark interactions, or to enhance survivorship of discards.

Modified techniques that have been used to land more sharks include fishing in more shallow depths, increasing the numbers of hooks deployed between floats, and generally setting gear closer to the bottom, presumably to land more coastal sharks during opened seasons (Hoey and Moore, 1999). These strategies are likely to yield high shark catch rates under certain conditions, at least in relation to large coastal species. For instance, POP data have revealed that 67% of silky sharks taken in the GOM were caught in depths inferior to 1000 meters, while the majority of dusky sharks (SAB) were captured in less

than 500 meters. As a basis of comparison, blue sharks and tuna were caught most frequently beyond the 1000 meter depth contour, while mako and common thresher sharks just around that threshold (Hoey and Moore, 1999). In the GOM, conditions for highest silky shark catches closely resembled those for swordfish, morning gear retrievals from less than 1000 meter depths. The avoidance by tuna-targeting vessels of areas where swordfish catches are high (shallow depths, < 500 meters, in the GOM, SAB, and FEC) should thus simultaneously reduce incidental silky shark catches (Hoey and Moore, 1999).

Additional studies have also documented the effects of gear shifts on CPUE. For example, the use of rope/steel ("Yankee") gangions has yielded a lower CPEU of juvenile sandbar sharks than when using monofilament gangions (Branstetter and Musick, 1993). In another study, percent-capture of blue shark with the use of monofilament gangions (66%) exceeded that when employing multifilament gangions (34%) (Stone and Dixon, 2001). Shortfin mako shark catches adhered to the same pattern (60% and 40% for 'mono' and 'multi' respectively). Stone and Dixon (2001) surmised that the relative aversion to the multifilament gangion could have been a function of strong visual acuity, a trait shared by pelagic predators that often hunt nocturnally. Investigating the effects of these alternate gears on additional elasmobranch species is certainly warranted for standardizing historical catch rates.

### **A9.3.3. Effects of J-style versus circle hooks**

As said, shifts in gear regimes can influence the catchability of both targeted and non-targeted species. A plethora of studies have addressed the effects on catch rates, location of hooking (e.g. internal versus external; gut versus mouth hooking), and resulting injuries and mortalities induced by differing hook types in teleosts (e.g. Bacheler and Buchel, 2004; Cooke *et al.*, 2005), pelagic teleosts (e.g. Domeier *et al.*, 2003; Kerstetter and Graves, 2006A; Kerstetter *et al.*, 2006; Kerstetter and Graves, 2006B) and in sea turtles (see Garrison, 2003; Watson *et al.*, 2005). Although sharks have only been directly (Yokota *et al.*, 2006) or secondarily (Watson *et al.*, 2005; Kerstetter and Graves, 2006B) addressed in a few such studies, methodologies in which to do so in future studies are now well established.

In general, these studies have found that the use of 18/0 (non-offset) circle hooks compared to 9/0 and 10/0 J-style hooks (in some cases in conjunction with mackerel bait) reduce the bycatch of sea turtles, increase the catch of target species such as yellowfin and bigeye tuna, increase the number of animals hooked in the mouth or jaw as opposed to the esophagus or gut, and mitigate the degree of hooking mortality and (estimated) post-release mortality of bycatch species. In response to these results, NMFS imposed a policy in August 2004 requiring all PLL vessels, time and area-independent (excluding the NED), to use only 16/0 or larger non-offset circle hooks and/or 18/0 or larger circle hooks with an offset not exceeding 10 degrees (NMFS, 2005; NMFS, 2006). Moreover, only whole finfish and squid baits may be utilized in the majority of areas, while only whole mackerel and squid baits may be possessed and/or utilized in the NED (when opened) (NMFS, 2006).

The potentially positive impact of circle-hook usage on hooking mortality and ultimate discard survivability is not a trivial issue for sharks. Significant interspecific differences in catch mortality rates have been found in sharks captured by PLL operations (Table A9.8) (Beerkircher *et al.*, 2002). Even if a pelagic species is discarded without overt physical depredatory damage, it can still succumb due to physiological stress (Moyes *et al.*, 2006), and cryptic injuries incurred while on or while being removed from the hook. Excluding tiger sharks and rays addressed in Beerkircher *et al.* (2002), most species demonstrated moderate to high rates of mortality upon gear retrieval. Even the resilient blue shark has exhibited modest (7-19% as cited earlier) degrees of hooking mortality. Thus, although difficult to distinguish by investigation, there is room for survival enhancement in even the most resilient species. The less injurious potential of circle hooks certainly bodes well for the variety of by-caught sharks if adhering to the same superficial hooking trends as in other species.

Table A9.8. Catch status of elasmobranchs observed in the pelagic longline fishery off the southeastern U.S., 1992–2000 (Beerkircher et al., 2002).

Species	Alive	Dead	Unknown	Damaged	% Dead
Silky	487	949	0	10	66.3
Dusky	348	325	0	6	48.7
Night	110	451	0	11	80.8
Blue	381	49	0	4	12.2
Tiger	255	8	0	0	3.0
Scalloped hammerhead	77	117	1	5	61.0
Oceanic whitetip	95	36	0	0	27.5
Rays	113	0	0	0	0.0
Sandbar	82	29	0	1	26.8
Bigeye thresher	38	43	0	1	53.7
Shortfin mako	52	28	0	0	35.0

Among the studies considering shark catchability as a function of hook and/or bait type, the results are inconclusive regarding catch rates and the use of circle hooks. Watson et al. (2002) found circle hooks to yield higher catch rates of blue sharks than with J-style hooks, independent of bait type. This discrepancy, however, was acknowledged as a possible function of increased bite-offs of the monofilament leaders (and thus high unaccounted blue shark catch) due to the swallowing and/or deeper lodging of J-style hooks. Otherwise, studies have uniformly found no effect between the hook types on blue shark catch rates (Yokota *et al.*, 2006; Kerstetter *et al.*, 2006; Kerstetter and Graves, 2006B). Although hooking has been found to be deeper (e.g. esophageal or stomach) in J-style than in circle hooks independent of bait type and offset (in circle hooks), catch mortalities of blue sharks have not differed accordingly (Yokota *et al.*, 2006; Kerstetter and Graves, 2006B; Kerstetter *et al.*, 2006). The lack of difference is likely ascribable to the species already displaying high hooking survivorship, whereby discerning a difference due to hook type is difficult. Anecdotally, the conventional “Japanese (tuna) hooks”, which are currently prohibited from use, may actually reduce shark catch rates more than the circle hooks (John Hoey, personal communication).

Interestingly, it has been found that the use of mackerel baits reduced the blue shark catch rates associated with both circle (31%) and J-style (40%) hooks (Watson *et al.*, 2005). Thus, a switch in bait regimes may hold greater influence on mitigating shark bycatch than hook type.

In the best interest of management, conservation, and industry, investigating the effects of both hook and bait types in additional species of sharks caught by PLL is essential. The management regime shift to circle hooks in the U.S. PLL fishery in 2004 has likely resulted in a still-unquantified change in shark catch rates. Future analyses of shark CPUE changes via POP/logbook data will require careful comparison to account for the change in catchability between the two hook types. Anecdotally, there are on-going studies assessing the catch rate and hooking injury effects of circle hooks on a wide array of shark species caught in PLL operations.

#### A9.3.4. Ongoing work on hook repellants

Historically, there have been numerous measures designed, tested and implemented to repel sharks (see Sisneros and Nelson, 2001). The primary impetus behind the majority of these has been to deter shark attacks on humans. In response to the sometimes negative implications of incidental shark takes in the PLL fishery however, attention related to technologies with potential hook-repelling implications has heightened in recent years.

Focusing prominently on semiochemical repellants, *SharkDefense, LLC* (Oak Ridge, NJ) is actively engaged in field-testing products with applications for the PLL fishery. According to their website<sup>1</sup> (<http://www.sharkdefense.com/Fisheries/fisheries.html>), the company is presently augmenting previously successful demonstrations of chemical aversions in a mix of several (small and large coastal) tropical reef-oriented species by field-testing semiochemicals and other chemical synthetics repellants in pelagic

species such as blue sharks. Thus far, results have been promising. Presumably, this can be ascribed to an apparent aversion in sharks to certain chemicals, including ammonium acetate (a major component in decaying shark flesh) and other semiochemicals emitted from predators (Sisneros and Nelson, 2001). However, the methods of application and the deployments of such technologies in real-time remain uncertain. Field investigation into the efficacy of these practices has also proven challenging in that it is supposedly difficult to administer and monitor the repellants in a controlled fashion.

Most recently, Michael Hermann, a partner of *SharkDefense*, was awarded the World Wildlife Fund's (WWF) 2006 International 'Smart Gear' Competition grand prize for a technology intended to deter sharks from hooks. The invention, a highly powerful but small magnet deployed above the shaft of a hook (Fig. A9.5) is meant to repel sharks through an overstimulation of their acutely sensitive electromagnetic receptors. At present, the magnets have successfully deterred *Negaprion brevirostris* (the lemon shark) and *Ginglymostoma cirratum* (nurse shark) with little interference on targeted species. Again however, the efficacy of this deterrent under actual PLL conditions, and on pelagic species which certainly employ very different foraging strategies, has yet to be documented.

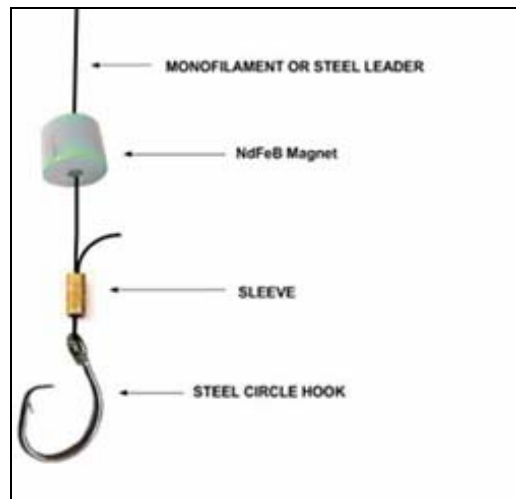

Fig. A9.7. Illustration of a magnet prototype that received first prize in the 2006 World Wildlife Fund Smartgear Competition (<http://www.worldwildlife.org/oceans/projects/smartgear.cfm>).

#### A9.3.5. Next steps

To better evaluate the extent of shark bycatch in the Atlantic and to derive means to reduce incidental interactions with sharks in the PLL fishery, a more thorough analysis of the available data sources (POP and logbook) must be conducted. Of utmost importance is the treatment of seasonality, seawater temperature profiles, depth-of-fishing, and geographic area as primary variables possibly impacting shark catches (John Hoey, personal communication). The better conditions leading to increased takes of specific shark species are understood, the more feasible it will be to establish mitigation tools and management strategies.

The reconciliation of POP and logbook data also represents a major step to better understanding the extent of shark takes and would expound upon advisable future management strategies in relation to sharks. Although there has been some concordance in these data (e.g. Brooks et al., 2005), the fishing industry has anecdotally alluded to an often wide discrepancy between perceptions by fishermen and observers. For example, one anonymous fisherman vicariously described a true case of divergence over how many blue sharks had been caught across several sets on the Grand Banks: "On what I think was the first trip he took an observer on back in the early '80s, the observer asked how many blue [sharks] they caught. [The] "unnamed fisherman" guessed about 250. The observer said, 80. The numbers might not be exactly those, but the "unnamed fisherman" was really taken aback that he'd misjudged the number so wildly. I think it just emphasizes how perception seems to alter reality." This example illustrates that amidst the demand and commotion of fishing operations, the under- and/or over-reporting of non-

targeted catch is plausible, in which cases the resulting data can grossly misrepresent what is actually occurring.

As previously discussed, it is also important to better resolve the sources and rates of shark depredation across a variety of parameters. The prospect of doing so will be strengthened subsequent to the onset of more detailed recording protocols (e.g. shark versus pilot whale) for damaged catch in the POP.

As personal methods for the reduction of bycatch and depredation have most certainly been derived through practice by industry, gaining the insights of the fishermen would represent an invaluable component to this assessment of the PLL fleet in the U.S. Atlantic. Regrettably, we were unable to reflect industry's sentiments here. The incorporation of their strategies and viewpoints would thereby represent a logical next step in the assessment, especially in relation to shark bycatch and depredation mitigation practices.

Finally, it is critical to continue developing and field-testing new technologies and strategies to help reduce shark takes in this fishery. If communication lines are enhanced, promising practices can better be distributed across geographic boundaries as a means for influencing global PLL fisheries where sharks are encountered.

#### A9.4. References

- Abercrombie, D.L., H.A. Balchowsky, and A.L. Paine. 2005. 2002 and 2003 annual summary: large pelagic species. NOAA Technical Memorandum NMFS SEFSC-529. 33p.
- Atlantic Pelagic Longline Take Reduction Team (APLTRT). 2006. Draft Atlantic Pelagic Longline Take Reduction Plan, submitted to NMFS.  
([http://www.nmfs.noaa.gov/pr/pdfs/interactions/pltrp\\_draft\\_8June06.pdf](http://www.nmfs.noaa.gov/pr/pdfs/interactions/pltrp_draft_8June06.pdf) viewed 11-20-06)
- Bacheler, N.M., and J.A. Buchel. 2004. Does hook type influence the catch rate, size, and injury of grouper in a North Carolina commercial fishery? *Fish. Res.* 69: 303-311.
- Barker, M.J., and V. Schluessel. 2004. Managing global shark fisheries: suggestions for prioritizing management strategies *Aquatic Conservation: Mar. Freshwater Ecosyst.* 15: 325-347.
- Baum, J. K., and R. A. Myers. 2004. Shifting baselines and the decline of pelagic sharks in the Gulf of Mexico. *Ecology Letters.* 7: 135-145.
- Baum, J. K., R. A. Myers, D. Kehler, L. Gerber, W. Blanchard and S. J. Harley. 2002. Preliminary standardized catch rates for pelagic and large coastal sharks from logbook and observer data from the Northwest Atlantic. *Col. Vol. Sci. Pap. ICCAT.* 54(4):1294-1313.
- Baum, J.K., R.A. Myers, D.G. Kehler, B. Worm, S.J. Harley, and P.A. Doherty. 2003. Collapse and conservation of shark populations in the northwest Atlantic. *Science.* 299: 389-392.
- Beerkircher, L. R., E. Cortes, and M. Shivji. 2004. Characteristics of shark bycatch observed on pelagic longlines off the southeastern United States, 1992-2000. *Mar. Fish. Rev.* 64(4):40-49.
- Beerkircher, L. R., C. J. Brown, D. L. Abercrombie, and D. W. Lee. 2004. SEFSC Pelagic Observer Program Data Summary for 1992-2002. NOAA Technical Memorandum NMFS-SEFSC-522, 25 pp.
- Berkeley, S.A., and W. L. Campos. 1988. Relative abundance and fishery potential of pelagic sharks along Florida's east coast. *Mar. Fish. Rev.* 50: 9-16.
- Bonfil, R. 1994. Overview of world elasmobranch fisheries. Technical report, Rome: FAO. 341 pp.
- Branstetter, S., and J.A. Musick. 1993. Comparisons of shark catch rates on longlines using rope/steel (Yankee) and monofilament gangions. *Mar. Fish. Rev.* 55: 4-9.
- Brooks, E.N., M. Ortiz, L.K. Beerkircher, P. Apostolaki, and G. Scott. 2005. Standardized catch rates for blue shark and shortfin mako shark from the U.S. pelagic logbook and U.S. pelagic observer program, and US weightout landings. *Col. Vol. Sci. Pap. ICCAT.* 58(3): 1054-1072.
- Campana, S.E., L. Marks, W. Joyce, and N. Kohler. 2005. Catch, By-catch and indices of population status of blue shark (*Prionace glauca*) in the Canadian Atlantic. *Col. Vol. Sci. Pap. ICCAT.* 58(3): 891-934.
- Campana, S.E., L. Marks, W. Joyce, and N. Kohler. 2006. Effects of recreational and commercial fishing on blue sharks (*Prionace glauca*) in Atlantic Canada, with inferences on the North Atlantic population. *Can. J. Fish. Aquat. Sci.* 63: 670-682.

- Cooke, J.G., and J.R. Beddington. 1984. The relationship between catch rates and abundance in fisheries. *IMA J. Math. Appl. Med. Biol.* 1: 391-405.
- Cortés, E. 2000. Catch rates of pelagic sharks from the northwestern Atlantic, Gulf of Mexico, and Caribbean. *Col. Vol. Sci. Pap. ICCAT.* 51: 1822-1829.
- Cortés, E. 2002. Catches and catch rates of pelagic sharks from the Northwestern Atlantic, Gulf of Mexico, and Caribbean. *Col. Vol. Sci. Pap. ICCAT.* 54(4): 1164-1181.
- Cramer, J. 1997A. Large Pelagic logbook catch rates indices for sharks. *Col. Vol. Sci. Pap. ICCAT.* 46(4): 402-404.
- Cramer, J. 1997B. Estimates of the numbers and metric tons of sharks discarded dead by pelagic longline vessels. *Col. Vol. Sci. Pap. ICCAT.* 46(4): 436-445.
- Cramer, J. 1997C. By-catch of blue sharks (*Prionace glauca*) reported by U.S. pelagic longline vessels from 1987-1995. *Col. Vol. Sci. Pap. ICCAT.* 46(4): 456-464.
- Cramer, J., A. Bertolino, and G. P. Scott. 1997. Estimates of recent shark bycatch by U.S. vessels fishing for Atlantic tuna and tuna-like species. *Col. Vol. Sci. Pap. ICCAT.* 48(3): 117-128.
- Cramer, J. 2000. Large pelagic logbook catch rates for sharks. *Col. Vol. Sci. Pap. ICCAT.* 51(6): 1842-1848.
- Cramer, J., A. Bertolino, and H. Adams. 2000. Shark bycatch from the U. S. longline fleet, 1982 through 1992. *Col. Vol. Sci. Pap. ICCAT.* 51(6): 1830-1841.
- Crowder, L. B., and R.A. Myers. 2001. Report to Pew Charitable Trusts: a comprehensive study of the ecological impacts of the worldwide pelagic longline industry. (Available at: [http://moray.ml.duke.edu/faculty/crowder/research/crowder\\_and\\_myers\\_Mar\\_2002.pdf](http://moray.ml.duke.edu/faculty/crowder/research/crowder_and_myers_Mar_2002.pdf) viewed 11-20-06).
- Domeier, M.L., H. Dewar, and N. Nasby-Lucas. 2003. Mortality rate of striped marlin (*Tetrapturus audax*) caught with recreational tackle. *Mar. Freshwater Res.* 54: 435-445.
- Diaz, G.A. 2006. Estimation of large coastal sharks dead discards for the U.S. pelagic longline fishing fleet. *ICCAT LCS05/06-DW-18.*
- Diaz, G.A., and J.E. Serafy. 2005. Longline-caught blue shark (*Prionace glauca*): factors affecting the numbers available for live release. *Fish. Bull.* 103: 720-724.
- Department of Fisheries and Oceans Canada (DFO). 2002. Catch, bycatch and landings of blue shark in the Canadian Atlantic. DFO Science Fisheries Status Report 2002/02E. (Available at: [http://www.mar.dfo-mpo.gc.ca/science/rap/internet/FSR\(2002\)2E.pdf](http://www.mar.dfo-mpo.gc.ca/science/rap/internet/FSR(2002)2E.pdf) viewed 11-20-06)
- Food and Agriculture Organization of the United Nations (FAO), 1999. International Plan of Action for the Conservation and Management of Sharks. Document FI:CSS/98/3, Rome. 26 pp.
- Garrison, L.P. 2003. Estimated bycatch of marine mammals and turtles in the U.S. Atlantic pelagic longline fleet during 2001-2002. NOAA Technical Memorandum NMFS-SEFSC-515. 60 pp. (Available at: [http://www.sefsc.noaa.gov/PDFdocs/TM\\_515\\_Garrison\\_Erratum.pdf](http://www.sefsc.noaa.gov/PDFdocs/TM_515_Garrison_Erratum.pdf) viewed 11-20-06).
- Harrington, J.M., R.A. Myers, and A.A. Rosenberg. 2005. Wasted resources: bycatch and discards in U.S. Fisheries. In U.S. Fisheries Atlas of Bycatch (prepared by MRAG Americas, Inc. for Oceana). 286 pp.
- Hoey, J.J., and N. Moore. 1999. Captain's report: multi-species characteristics for the U.S. pelagic longline fishery. National Fisheries Institute Report to NOAA, National Marine Fisheries Service, Silver Spring, MD, USA. (Available at: <http://www.sefsc.noaa.gov/seaturtlecontractreports.jsp>; viewed 11-16-06)
- Hoey, J.J., E. Pritchard, C. Brown, and M. Showell. 2002. Pelagic shark abundance indices based on fishery-dependent and fishery-independent data from the western North Atlantic. *Col. Vol. Sci. Pap. ICCAT.* 54(4): 1199-1211.
- Kerstetter, D.W., and J.E. Graves. 2006A. Survival of white marlin (*Tetrapturus albidus*) released from commercial pelagic longline gear in the western North Atlantic. *Fish. Bull.* 104: 434-444.
- Kerstetter, D.W., and J.E. Graves. 2006B. Effects of circle versus J-style hooks on target and non target species in a pelagic longline fishery. *Fish. Res.* 80: 239-250.
- Kerstetter, D.W., J.C. Pacheco, F.H. Hazin, P.E. Travassos, and J.E. Graves. 2006. Preliminary results of circle and J-style hook comparisons in the Brazilian pelagic longline fishery. *ICCAT SCRS/2006/150.*
- Matsunaga, H., and H. Nakano. 2005. Estimation of shark catches by Japanese tuna longline vessels in the Atlantic Ocean. *Col. Vol. Sci. Pap. ICCAT.* 58(3): 1096-1105.
- Moyes, C.D., N. Fragoso, M.K., Musyl, and R.W. Brill. 2006. Predicting postrelease survival in large pelagic fish. *Trans. Amer. Fish. Soc.* 135: 1389-1397.

- Musick, J. A., G. Burgess, G. Cailliet, M. Camhi, and S. Fordham. 2000. Management of sharks and their relatives (Elasmobranchii). *Fisheries* 25(3): 9-13.
- Nakano, H., and M. Honma. 1996. Historical CPUE of pelagic sharks caught by the Japanese longline fishery in the Atlantic Ocean. *Col. Vol. Sci. Pap. ICCAT*. 46(4): 393-398.
- National Marine Fisheries Service (NMFS). 1993. Fishery management plan for sharks of the Atlantic Ocean. National Oceanic and Atmospheric Administration, Silver Spring, MD, 167 pp.
- National Marine Fisheries Service (NMFS). 1999. Final Fishery Management Plan for Atlantic Tunas, Swordfish, and Sharks. Vol. 1. National Oceanic and Atmospheric Administration, Silver Spring, MD, 321 pp.
- National Marine Fisheries Service (NMFS). 2001. U.S. Plan of Action for the Conservation and Management of Sharks. National Oceanic and Atmospheric Administration, Silver Spring, MD. 26 pp.
- National Marine Fisheries Service (NMFS). 2003. Final Amendment 1 to the Fishery Management Plan for Atlantic Tunas, Swordfish and Sharks. NMFS, Highly Migratory Species Management Division. Silver Springs, MD. (Available at: [http://www.nmfs.noaa.gov/sfa/hms/Amendment1/Final\\_EIS\\_Chapters/Chapter01.pdf](http://www.nmfs.noaa.gov/sfa/hms/Amendment1/Final_EIS_Chapters/Chapter01.pdf) viewed 11-20-06).
- National Marine Fisheries Service (NMFS). 2005. Draft consolidated Atlantic highly migratory species fishery management plan. August 2005. Volume I. 51 pp. (Available at: <http://www.nmfs.noaa.gov/sfa/hms/Amendment2/DEIS%20Exec%20Sum.pdf> viewed 11-20-06)
- National Marine Fisheries Service (NMFS). 2006. Annual report of United States of America. ICCAT ANN/2005/038.
- Scott, G.P. 1997. Recent trends in catch rates of some Atlantic sharks. *Col. Vol. Sci. Pap. ICCAT*. 46(4): 409-414.
- Senba, Y., and H. Nakano. 2005. Summary of species composition and nominal CPUE of pelagic sharks based on observer data from the Japanese longline fishery in the Atlantic Ocean from 1995 to 2003. *Col. Vol. Sci. Pap. ICCAT*. 58(3): 1106-1117.
- Simpfendorfer, C.A., R.E. Hueter, U. Bergman, and S.M.H. Connert. 2002. Results of a fishery-independent survey for pelagic sharks in the western North Atlantic, 1977-1994. *Fish. Res.* 55: 175-192.
- Sisneros, J.A., and D.R. Nelson. 2001. Surfactants as chemical repellants: past, present, and future. *Env. Biol. Fish.* 60: 117-129.
- Stone, H.H., and L.K. Dixon. 2001. A comparison of catches of swordfish, *Xiphias gladius*, and other pelagic species from Canadian longline gear configured with alternating monofilament and multifilament nylon gangions. *Fish. Bull.* 99: 210-216.
- Ward, P., R. A. Myers, and W. Blanchard. 2004. Fish lost at sea: the effect of soak time on pelagic longline catches. *Fish. Bull.* 102:179-195.
- Watson, J.W., S.P. Epperly, A.K. Shah, and D.G. Foster. 2005. Fishing methods to reduce sea turtle mortality associated with pelagic longlines. *Can. J. Fish. Aquat. Sci.* 62: 965-981.
- Yokota, K, M. Kiyota, and H. Minami. 2006. Shark catch in a pelagic longline fishery: Comparison of circle and tuna hooks. *Fish. Res.* 81: 337-341.



## Appendix 10

### Contributing Authors' Contact Details

**Joanna Alfaro-Shigueto and Jeff Mangel**

Pro Delphinus  
Octavio Bernal 572-5  
Lima 11 PERU  
Email: [prodelphinus@prodelphinus.org](mailto:prodelphinus@prodelphinus.org)

**Nigel Brothers**

Consultant, Marine Ecology and Technology  
178 South Arm Drive, Wonga Beach  
Queensland, 4873 AUSTRALIA  
Email: [brothersbone@yahoo.com.au](mailto:brothersbone@yahoo.com.au)

**Dr. Shelley Clarke**

Research Associate  
Imperial College London  
Silwood Park Campus, Manor House  
Buckhurst Road  
Ascot SL5 7PY, UK  
[scclarke@biznetvigator.com](mailto:scclarke@biznetvigator.com)

**Paul Dalzell**

Western Pacific Regional Fishery Management  
Council  
1164 Bishop Suite, Suite 1400  
Honolulu, HI 96813 U.S.A.  
Email: [paul.dalzell@noaa.gov](mailto:paul.dalzell@noaa.gov)

**Miguel Donoso**

Instituto de Fomento Pesquero  
Blanco 839  
Valparaiso, V Region  
CHILE  
E-mail: [mdonoso@ifop.cl](mailto:mdonoso@ifop.cl)

**Eric Gilman**

Blue Ocean Institute and University of Tasmania  
School of Geography and Environmental  
Studies  
2718 Napuaa Place  
Honolulu, HI 96822 U.S.A.  
Email: [egilman@blueocean.org](mailto:egilman@blueocean.org)

**Dr. John Mandelman and Tim Werner**

New England Aquarium  
Central Wharf  
Boston, MA 02110 U.S.A.  
Email: [jmandelman@neaq.org](mailto:jmandelman@neaq.org),  
[twerner@neaq.org](mailto:twerner@neaq.org)

**Samantha Petersen and Meidad Goren**

BirdLife & WWF Responsible Fisheries  
Programme  
BirdLife South Africa  
PO Box 52026 Waterfront  
Cape Town, 8002 SOUTH AFRICA  
Email: [Seabirds@birdlife.org.za](mailto:Seabirds@birdlife.org.za)

**Dr. Susanna Piovano**

Dipartimento di Biologia Animale e dell'Uomo  
Università di Torino  
Via Accademia Albertina 13  
I-10123 Torino ITALY  
[susanna.piovano@unito.it](mailto:susanna.piovano@unito.it)

**Nicola Thomson**

Environment Consultants Fiji  
Box 2041, Government Buildings  
Suva FIJI  
Email: [watling@connect.com.fj](mailto:watling@connect.com.fj)